

# BOWER®

HEAVY DUTY BEARINGS by NTN

# NTN®

## DRIVETRAIN

SERVICE KITS, BEARINGS,  
SEALS & INTERCHANGES

DANA KIT APPLICATIONS  
EATON KIT APPLICATIONS  
FREIGHTLINER KIT APPLICATIONS  
MACK KIT APPLICATIONS  
MERITOR KIT APPLICATIONS

WINTER 2017 CATALOG



[ntnamericas.com](http://ntnamericas.com)

# SERVICE KIT FEATURES

## CASE CARBURIZED BEARINGS FOR LONG LIFE

All NTN BOWER bearings undergo a special heat treatment called case-carburization. This process creates a hardened steel “case” around the outside of the bearing with high wear and fatigue resistance, while leaving the “core” of the bearing tough and durable. This creates greatly increased component durability and extended bearing life just as the axle OEM intended. As a result, you increase maintenance intervals and reduce downtime.

### What does that mean for you?

- Increase maintenance intervals and reduce downtime

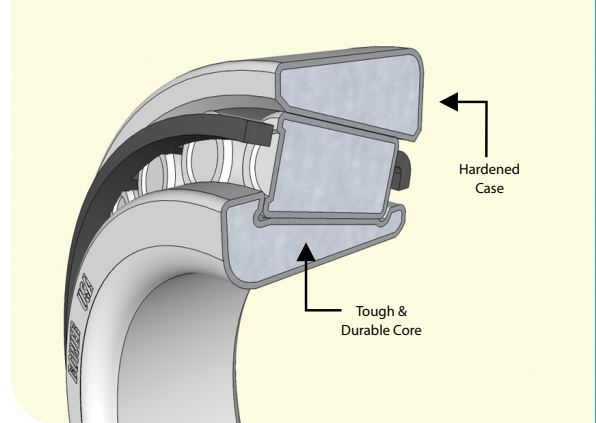

## TIGHTER TOLERANCES FOR EASY PINION SPACER SELECTION

NTN BOWER pinion bearings are made to the OEM axle manufacturer specification. This includes a width tolerance (front face stand height) that is over 70% tighter than standard bearing product.

### What does that mean for you?

- Quick, easy, and consistent pinion preload setting
- Use the nominal spacer more often
- Reduced pinion spacer inventory – cost savings
- Reduced pinion assembly time – cost savings

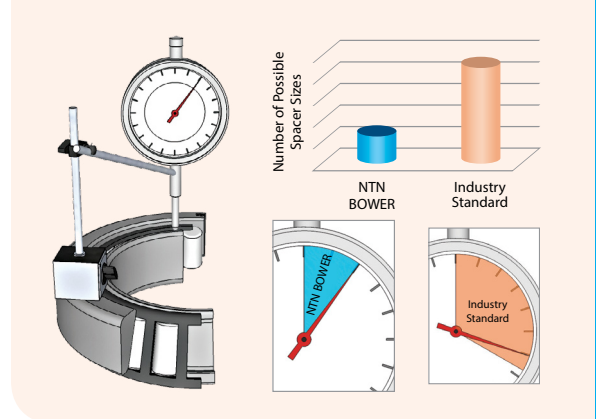

## OPTIMIZED CROWNING FOR INCREASED DIFFERENTIAL SIDE BEARING LIFE

The axle OEM understands that differential side bearings can lead a hard life. Heavy loads can cause the differential carrier and bearing cap assembly to deflect, resulting in excess stress on the bearing raceway that will lead to reduced bearing life. That is why the axle OEM worked with NTN BOWER to design these side bearings with special roller and raceway crowning features to extend bearing life.

### What does that mean for you?

- Extended bearing life

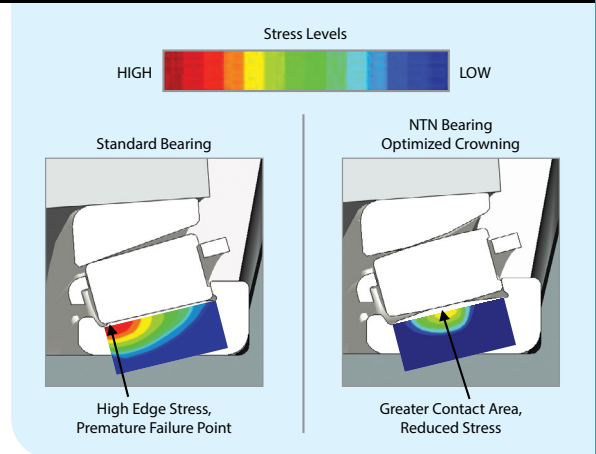

# BOWER NTN DRIVETRAIN SERVICE KITS FOR DIFFERENTIALS



NTN provides axle repair solutions for our powertrain rebuilder customers. These include heavy duty differential kits for popular OEM manufacturers such as DANA, Eaton, Freightliner, Mack, and Meritor. The contents for each repair kit are carefully selected to include high-quality, OEM preferred products, assuring complete satisfaction.

## **PREMIUM BRANDS, PREMIUM MATERIALS**

Our promise is to provide premium components, like genuine American-made BOWER bearings, that meet the exacting standards our customers have come to expect. And each component undergoes NTN's rigorous testing, ensuring parts live up to our quality standards.

## **SOLUTIONS FOR YOUR HEAVY DUTY APPLICATION**

We offer two types of differential kits to service the heavy duty truck marketplace.

Our master differential kits incorporate all the necessary components needed for the repair – application-specific bearings, seals, gaskets, o-rings, sealant, and threadlocker – providing the convenience of everything in one box.

We also offer a “V100” version of our master differential kits that excludes sealant and threadlocker. This cost saving option provides a unique, environmentally friendly solution for the professional rebuilder.

## **TABLE OF CONTENTS**

DANA Kit Applications by Kit .....	6
Eaton Kit Applications by Kit .....	7 - 12
Freightliner Kit Applications by Kit .....	13
Mack Kit Applications by Kit.....	13 - 14
Meritor Kit Applications by Kit.....	14 - 28
DANA Kit Applications by Axle .....	29
Eaton Kit Applications by Axle .....	30 - 35
Freightliner Kit Applications by Axle.....	36
Mack Kit Applications by Axle.....	36 - 37
Meritor Kit Applications by Axle.....	37 - 51
Kit Contents.....	52 - 111
Bearings.....	112 - 121
Seals .....	122 - 125
Interchanges.....	126 - 132

## DANA AXLE IDENTIFICATION

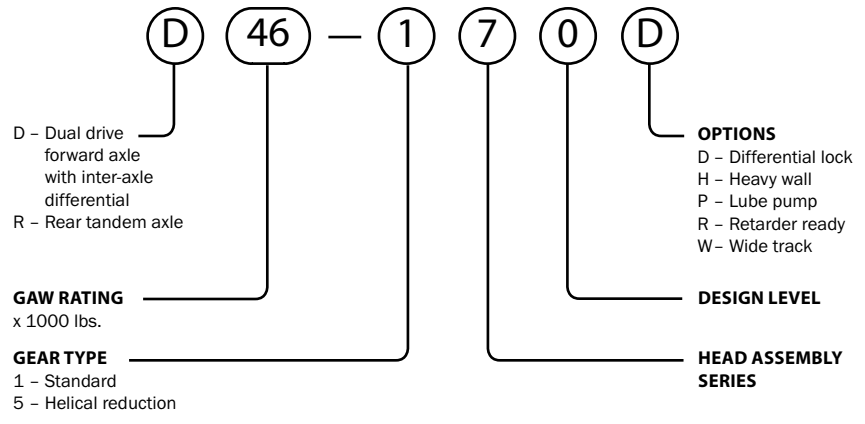
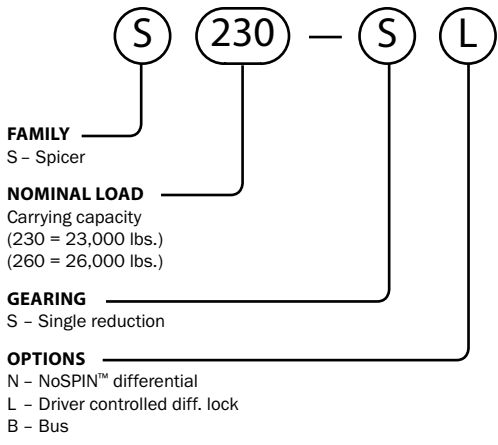

## EATON AXLE IDENTIFICATION

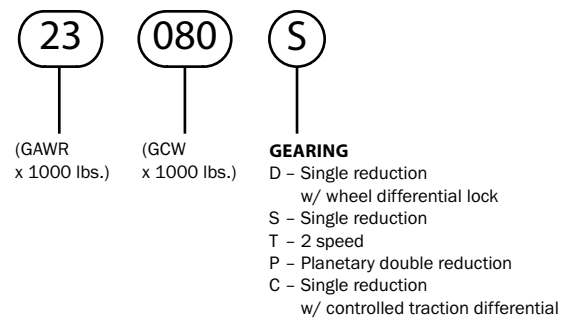
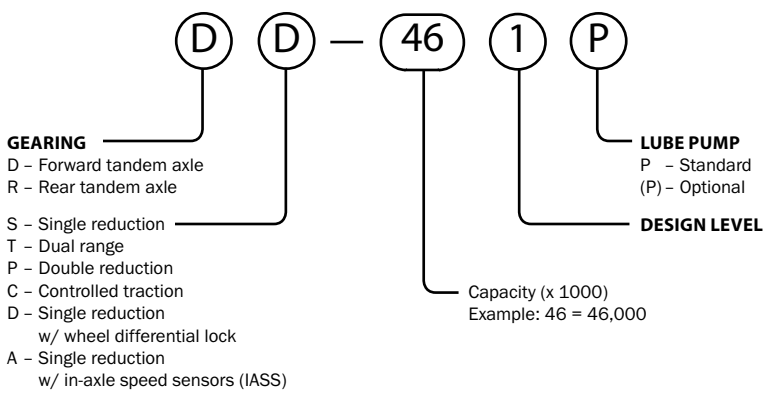

**MERITOR AXLE IDENTIFICATION**

**MAIN DIFFERENTIAL NEST TYPE**

- B - Special differential
- C - Driver controlled differential lock
- F - Standard differential
- H - High Traction® differential
- N - NoSPIN™ differential

**BRAKE TYPE**

- C - Dura-Master® air disc brake
- D - RDA Stopmaster® wedge brake (Dual air chambers)
- E - RDH Stopmaster® wedge brake (Dual hydraulic cylinders)
- F - RSH Stopmaster® wedge brake (Single hydraulic cylinder)
- L - Q Plus cam brake
- N - None
- P - Cam-Master® "P" series cam brake
- Q - Cam-Master® "Q" series cam brake
- S - RSA Stopmaster® wedge brake (Single air chamber)
- T - Cam-Master® "T" series cam brake
- W - Cam-Master® "W" series cam brake

**HUB TYPE**

- A - Aluminum
- F - Ferrous
- N - None

**MANUFACTURING LOCATION**

- A - Australia
- B - Brazil
- C - India
- D - Mexico (Dirona)
- E - Europe (C.V.C.)
- M - Europe (Maudslay)
- N - U.S.A.

**AXLE SPECIFICATION NUMBER**

Identifies specific customer axle configurations (variations from the original axle design). For information about the variation, see the bill of materials for the specific axle model.



**AXLE TYPE**

- C - Single rear drive axle, coach
- D - Forward-rear axle of a drive tandem with inter-axle differential
- N - Forward-rear axle of a drive tandem or tridem without inter-axle differential
- P - Forward-rear axle of a drive tandem with inter-axle differential and pump
- R - Rear-rear axle of a drive tandem
- S - Single rear drive axle
- T - Tandem drive axle set
- Z - Tridem drive axle set

**AXLE DESIGN VARIATION**

Indicates axle design level or variation, (e.g., RS 23 161 has a thicker wall housing than the RS 23 160). For information, see the bill of materials for that specific axle model.

**CARRIER TYPE**

Carrier size, large numbers indicate a higher GCW rates carrier, i.e., larger ring gear, etc.

**GEARING TYPE**

- 1 - Single speed
- 2 - Two speed
- 3 - Helical double reduction
- 4 - Salisbury single speed
- 5 - Planetary double reduction
- 6 - Hub reduction

**NOMINAL AXLE LOAD RATING (GAWR):**

In thousands of pounds. Individual forward and rear axles of a tandem set (D, N, P, R) are rated as a single axle. A tandem set (T) is rated as the combination of the two axles and a tridem set (Z) as the combination of the three axles.



DANA KIT APPS BY KIT		
Kit	Axle Model	Comments
<b>NDK191F</b>	RA341	
<b>NDK191R</b>	F155-S	
<b>NDK192R</b>	RA42	w/o Involute Splines and Serial #5141 & Above
	RA43	w/o Involute Splines and Serial #5141 & Above
	RA44	w/o Involute Splines and Serial #5141 & Above
	RA47	w/o Involute Splines and Serial #5141 & Above
	RA48	w/o Involute Splines and Serial #5141 & Above
	RA351	Serial #18798 & Above
	RA355	Diff Ser. #19798 & Up
	RA386	Diff Ser. #18798 & Up
<b>NDK192RB</b>	RA387	Diff Ser. #18798 & Up
	J175-S	
	J190-S	
	J210-S	
	J220-S	
	J230-S	
	J230-SB	
	J340-S	
<b>NDK200F</b>	J380-S	
	J400-S	
<b>NDK200FA</b>	RA472	
<b>NDK201F</b>	RA474	Involute Splines
<b>NDK201FA</b>	W440-S	
	W460-S	
<b>NDK201R</b>	W230-S	
	W440-S	
	W460-S	
<b>NDK214</b>	M185-D	
	M185-T	
	M190-T	
	M200-D	
	M200-T	
	M210-T	
	M220-D	
M220-T		
<b>NDK220FA</b>	M230-T	
<b>NDK223F</b>	J340-S	
	N340-S	
<b>NDK223R</b>	N400-I	
	N175	
	N190	

DANA KIT APPS BY KIT		
Kit	Axle Model	Comments
<b>NDK223R</b>	N340-S	
	N400-I	
<b>NDK414</b>	S135-S	
	S150-S	
<b>NDK416</b>	S230-S	
	S230-SB	
	S230-SL	
	S260-SB	
<b>NDK434</b>	S14-110	
	S14-111	
	S16-130	
	S16-132	
<b>NDK436</b>	D45-170DP	
	D40170DP	
<b>NDK437</b>	D52-190DP	
	D52-190P	
<b>NDK438</b>	D60-190P	
	R40-170	2.69-3.91 Ratios
	R46-170	2.69-3.91 Ratios
	S21-170	2.69-3.91 Ratios
	S23-170	2.69-3.91 Ratios
<b>NDK439</b>	R40-170	4.10-7.17 Ratios
	R46-170	4.10-7.17 Ratios
	S21-170	4.10-7.17 Ratios
	S23-170	4.10-7.17 Ratios
<b>NDK440</b>	R52-190P	2.53-4.78 Ratios
	R60-190P	2.53-4.78 Ratios
	S26-190P	2.53-4.78 Ratios
	S30-190P	2.53-4.78 Ratios
<b>NDK441</b>	R52-190P	5.25-7.83 Ratios
	R60-190P	5.25-7.83 Ratios
	S26-190P	5.25-7.83 Ratios
	S30-190P	5.25-7.83 Ratios
	D40-170	
<b>NDK442</b>	D40-170P	
	D46-170	
	D46-170H	
	D46-170HP	
	D46-170P	
<b>NDK443</b>	R40-170D	2.69-3.91 Ratios
	R46-170D	2.69-3.91 Ratios
	S21-170D	2.69-3.91 Ratios
	S23-170D	2.69-3.91 Ratios
<b>NDK444</b>	R40-170D	4.10-7.17 Ratios
	R46-170D	4.10-7.17 Ratios
	S21-170D	4.10-7.17 Ratios
	S23-170D	4.10-7.17 Ratios

EATON KIT APPS BY KIT		
Kit	Axle Model	Comments
NDK1	34R3	
	34RP	w/ Ribbed Carrier
	34RT	
	38R3	
	38RP	w/ Ribbed Carrier
	38RT	
	42R3	
	42RP	
	42RT	
	50RP	
	50RT	
	1880	
	1881	
	7800	
	7801	
	7810	
	8800	
	8802	
	8803	
	17200	
	17201	
	17202	
	17220	
	17221	
	17300	
	17301	
	17302	
	17320	
	17321	
	17322	
	17401	
	17421	
	17500	
	17501	
	17800	
	17810	
	18200	
	18201	
	18202	
	18207	
	18220	
	18221	
	18227	
	18300	
	18301	
	18302	
	18320	
	18321	
	18322	
	18500	
18501		
18502		
18503		
18800		
18802		
18803		
18812		
18813		
19060-T		
21060-T		
21221		
21321		

EATON KIT APPS BY KIT			
Kit	Axle Model	Comments	
NDK1	21421		
	DS385		
	RC341		
	RC381		
	RC386		
	RC401		
	RC402		
	RC406		
	RC451		
	RC3416		
	RC4026		
	RP340		
	RP341		
	RP380P	1- Speed Carrier After 4/30/78	
	RP381P		
	RP386-P		
	RP400P		
	RP401P		
	RP402P		
	RP406-P		
	RP451-P		
	RP3416-P		
	RP4026-P		
	RS340	2- Speed Carrier Before 4/30/78	
	RS380		
	RS400	2- Speed Carrier Before 4/30/78	
	RT340		
	RT341		
	RT380P		
	RT381P		
	RT386-P		
	RT400P		
	RT401P		
	RT402P		
	RT406-P		
	RT451-P		
	RT3416-P		
	RT4026-P		
	NDK1A	34RP	w/ Conical Carrier
		34RS	w/ Conical Carrier
34RSB			
38RP		w/ Conical Carrier	
38RS			
38RSB			
17100			
17101			
17120			
17121			
17123			
18100			
18101			
18103			
18120			
18121			
18123			
21121			
RS340	1 Speed Carrier After 4/30/78		
RS341	Before 4/6/89		
RS380			
RS381			
RS386			
RS400	1 Speed Carrier After 4/30/78		

EATON KIT APPS BY KIT		
Kit	Axle Model	Comments
NDK1A	RS401	
	RS402	Before 4/6/89
	RS403	Before 4/6/89
	RS406	
	RS451	Before 4/6/89
	RS3416	
	RS4026	
NDK18D	42RS	
	19120	
	19121	Exc. Dodge
	19123	
	20120	
	20121	
	20123	
	26120	Small Spherical Differential
	26121	Small Spherical Differential
26123	Small Spherical Differential	
NDK18E	44RSB	w/ Large Spherical Differential
	23120	Large Spherical Differential
	23121	Non-GMC Trucks
	26120	Large Spherical Differential
	26121	Large Spherical Differential
	26123	Large Spherical Differential
	RS440	
	RS446	w/o Traction Control
	RS460	
NDK23	30R3	
	30RP	
	30RS	w/ Ribbed Carrier
	30RT	
	1618	
	1619	
	3803	
	6802	
	16320	
	16321	
	16500	
	16501	
	16620	w/ 15" Ring Gear
	16800	
	16802	
	16803	
	NDK23B	30RS
NDK23D	16120	
	16123	
	16220	w/ 15-1/2" Ring Gear
	16244	
	16247	
	16344	
	19050-P	
19050-T		
NDK24	350	
	1350	Exc. Dodge 1957-1958
	3800	
	3802	
	13602	
	13800	
	13802	
	13803	
15040-S		

EATON KIT APPS BY KIT		
Kit	Axle Model	Comments
NDK24	15040-T	
	15101	
	15200	
	15201	
	15300	
	15301	
NDK64F	34D3	w/ Ball Bearing On Input Shaft
	34DP	w/ Ball Bearing On Input Shaft
	34DS	w/ Ribbed Barrier & Ball Bearing On Input Shaft
	34DT	w/ Ball Bearing On Input Shaft
	38D3	w/ Ball Bearing On Input Shaft
	38DP	w/ Ball Bearing On Input Shaft
	38DS	w/ Ribbed Barrier & Ball Bearing On Input Shaft
	38DT	w/ Ball Bearing On Input Shaft
	42D3	w/ Ball Bearing On Input Shaft
	42DP	w/ Ball Bearing On Input Shaft
	42DT	w/ Ball Bearing On Input Shaft
	NDK64FC	34DS
38DS		w/Conical Carrier & Ball Bearing On Input Shaft
NDK64FD	34DS	w/Conical Carrier & Taper Bearing On Input Shaft
	38DS	w/Conical Carrier & Taper Bearing On Input Shaft
NDK64FE	34D3	w/ Taper Bearing On Input Shaft
	34DP	w/ Taper Bearing On Input Shaft
	34DS	w/ Ribbed Carrier & Taper Bearing On Input Shaft
	34DT	w/ Taper Bearing On Input Shaft
	38D3	w/ Taper Bearing On Input Shaft
	38DP	w/ Taper Bearing On Input Shaft
	38DS	w/ Ribbed Barrier & Taper Bearing On Input Shaft
	38DT	w/ Taper Bearing On Input Shaft
	42D3	w/ Taper Bearing On Input Shaft
	42DP	w/ Taper Bearing On Input Shaft
	42DT	w/ Taper Bearing On Input Shaft
	NDK72	502
503		
9502		
9503		
9512		
19200		
19201		
19202		
19300		
19301		
19500		
19501		
19502		
19503		
19512		
19513		
19515		
20000		
20200		
20201		
20300		
20301		
20500		
20501		



EATON KIT APPS BY KIT			
Kit	Axle Model	Comments	
NDK72	20502		
	20503		
	23202		
	23302		
NDK72A	44DT		
	44RPB		
	44RT	w/o 103537 Case	
	44RTB		
	19220	w/o 103537 Case	
	19221	w/o 103537 Case	
	19223		
	19320		
	19321	w/o 103537 Case	
	19323		
	20220	w/o 103537 Case	
	20223		
	20320	w/o 103537 Case	
	20321	w/o 103537 Case	
	20323		
	23220	w/ 27950 Case	
	23221	w/ 27950 Case	
	23320	w/ 27950 Case	
	23321	w/ 27950 Case	
	26220	w/ 27950 Case	
	26221	w/ 27950 Case	
	26223	w/ 27950 Case	
	26321	w/ 27950 Case	
	26323	w/ 27950 Case	
	33321	w/ 27950 Case	
	NDK72B	44RT	w/ 103537 Case
		19220	w/ 103537 Case
19221		w/ 103537 Case	
19321		w/ 103537 Case	
20220		w/ 103537 Case	
20221		w/ 103537 Case	
20221		w/o 103537 Case	
20320		w/ 103537 Case	
20321		w/ 103537 Case	
23080P		Before 4/6/88	
23080T		Before 4/6/88	
23220		w/ 103537 Case	
23221		w/ 103537 Case	
23320		w/ 103537 Case	
23321		w/ 103537 Case	
26085P		Before 4/6/88	
26085T		Before 4/6/88	
26220		w/ 103537 Case	
26221		w/ 103537 Case	
26320		w/ 103537 Case	
26321		w/ 103537 Case	
26323		w/ 103537 Case	
33321		w/ 103537 Case	
RC4616			
RC5216			
RP440			
RP446P			
RP460			
RP466P			
RP480			
RP485			
RP550			
RS446	w/ Traction Control		

EATON KIT APPS BY KIT		
Kit	Axle Model	Comments
NDK72B	RS466	w/ Traction Control
	RT440	
	RT446P	
	RT460	
	RT466P	
	RT480	
	RT485	
NDK196	RT550	
	DA402P	After 1/1/95
	DS341P	After 1/1/95
	DS341P	Before 4/6/89
	DS381P	
	DS401P	
	DS402P	After 1/1/95
	DS402P	Before 4/6/89
	DS403P	After 1/1/95
	DS403P	Before 4/6/89
NDK202	DS451P	After 1/1/95
	DS451P	Before 4/6/89
	7500	
	9000	
NDK207	10000	
	12000	
	DC341P	
	DC381P	
	DC401-P	
	DC402P	
	DC451-P	
	DP341P	
	DP381P	
	DP401P	
	DP402P	
	DP451-P	
	DT341P	
NDK208	DT381P	
	DT401P	
	DT402P	
	DT451-P	
	DS440-P	36 Spline & Case #110500
	DS460-P	36 Spline & Case #110500
	DS461-P	Prior 2/2000
	DS462-P	Prior 2/2000
NDK208A	DS463-P	Prior 2/2000
	DS480-P	36 Spline & Case #110500
	DS521-P	Prior 2/2000
	DS581-P	Prior 2/2000
	DS601P	Prior 2/2000
	DS651-P	Prior 2/2000
	44DS	
	44DSM	
NDK209	DS440-P	22 Spline & Case #103530
	DS460-P	22 Spline & Case #103530
	DS480-P	22 Spline & Case #103530
	DP440-P	22 Spline & Case #103530
	DP460-P	22 Spline & Case #103530
	DP480-P	22 Spline & Case #103530
	DT440-P	22 Spline & Case #103530
NDK210	DT460-P	22 Spline & Case #103530
	DT480-P	22 Spline & Case #103530
	DP440-P	36 Spline & Case #110500
NDK210	DP460-P	36 Spline & Case #110500
	DP480-P	36 Spline & Case #110500

EATON KIT APPS BY KIT			
Kit	Axle Model	Comments	
<b>NDK210</b>	DT440-P	36 Spline & Case #110500	
	DT460-P	36 Spline & Case #110500	
	DT480-P	36 Spline & Case #110500	
<b>NDK211F</b>	DC460-P		
	DC461-P	Prior 2/2000	
	DC462-P	Prior 2/2000	
	DC463-P	Prior 2/2000	
	DC480-P		
	DC521-P	Prior 2/2000	
	DD461-P	Prior 2/2000	
	DD462-P	Prior 2/2000	
	DD463-P	Prior 2/2000	
	DD581-P	Prior 2/2000	
	DD601P	Prior 2/2000	
	DD651P	Prior 2/2000	
	DP461-P	Prior 2/2000	
	DP462-P	Prior 2/2000	
	DP463-P	Prior 2/2000	
	DP485-P		
	DP521-P	Prior 2/2000	
	DP550	36 Spline & Case #110500	
	DP580-P	36 Spline & Case #110500	
	DP601-P	Prior 2/2000	
	DP650-P	36 Spline & Case #110500	
	DP651-P	Prior 2/2000	
	DT461-P	Prior 2/2000	
	DT462-P	Prior 2/2000	
	DT463-P	Prior 2/2000	
	DT480-P		
	DT521-P	Prior 2/2000	
	DT580-P	36 Spline & Case #110500	
	DT601-P	Prior 2/2000	
	DT650-P	36 Spline & Case #110500	
	DT651-P	Prior 2/2000	
	<b>NDK211FA</b>	DP550	22 Spline & Case #103530
		DP580-P	22 Spline & Case #103530
DP650-P		22 Spline & Case #103530	
DT580-P		22 Spline & Case #103530	
<b>NDK219R</b>	DT650-P	22 Spline & Case #103530	
	44RS	w/ Casting #C98493 After 2/1/79	
	3527	w/ 103537 Case	
	19227	After 2/1/79	
	19237	After 2/1/79	
	23080P	After 4/6/88	
	23080T	After 4/6/88	
	23085C		
	23227	After 2/1/79	
	23327	Before 2/1/79	
	23420	Before 2/1/79	
	23421	After 2/1/79	
	23427		
	23430	w/ CTD	
	23433		
	26085P	After 4/6/88	
	26085T	After 4/6/88	
	26421		
	30055P		
	35055P		
	35227	w/ 103537 Case	
RC460			
RC461			
RC462			

EATON KIT APPS BY KIT		
Kit	Axle Model	Comments
<b>NDK219R</b>	RC463	
	RC480	
	RC521	
	RC601	
	RC651	
	RD461	
	RD462	
	RD463	
	RD521	
	RD581	
	RD540	
	RP461	
	RP462	
	RP463	
	RP521	
	RP580	
	RP601	
	RP650	
	RP651	
	RP4616P	
	RP5216P	
	RP6016P	
	RP6516P	
	RS580	w/ Traction Control
	RS650	w/ Traction Control
	RT461	
	RT462	
	RT463	
	RT521	
	RT580	
	RT601	
	RT650	
	RT651	
RT4616P		
RT5216P		
RT6016P		
RT6516P		
<b>NDK220F</b>	SP461	
	SP462	
	SP463	
	SP521	
	SP601	
	SP651	
	TP461	
	TP462	
	TP463	
	TP521	
<b>NDK222F</b>	TP601	
	TP651	
	DA402P	4/6/89 through 12/31/94
	DS341P	4/6/89 through 12/31/94
	DS402P	4/6/89 through 12/31/94
<b>NDK222R</b>	DS403P	4/6/89 through 12/31/94
	DS451P	4/6/89 through 12/31/94
	RA402	4/6/89 through 12/31/94
	RS341	4/6/89 through 12/31/94
	RS402	4/6/89 through 12/31/94
<b>NDK401</b>	RS403	4/6/89 through 12/31/94
	RS451	4/6/89 through 12/31/94
	23105-C	
	26105-C	
	30105-C	

EATON KIT APPS BY KIT		
Kit	Axle Model	Comments
NDK402	23105-S	
	26105-S	
	30105-S	
NDK403	19055-P	
	19055-T	
	21065-P	
	21065-T	
	21065-Y	
	22065-P	
	22065-T	
	22220	
	22221	
	22320	
	22321	
	22420	
	22421	
22427		
NDK404F	DA344	
	DA404P	Before 6/16/08
	DA405P	Before 6/16/08
	DA454P	
	DS344	Before 6/16/08
	DS404P	Before 6/16/08
	DS405P	Before 6/16/08
DS454P		
NDK404FA	DST40P	Before 6/16/08
	DA404P	After 6/16/08
	DA405P	After 6/16/08
	DS344	After 6/16/08
	DS404P	After 6/16/08
NDK404R	DS405P	After 6/16/08
	DST40P	After 6/16/08
	17060S	
	19060S	
	21060S	
	22060S	
	RA344	
	RA404	
	RA405	
	RA454	
	RS344	
RS404		
RS405		
RS454		
NDK405F	DD404P	Before 6/16/08
	DD405P	Before 6/16/08
	DD454P	
	DDT40-P	Before 6/16/08
	DDT41P	Before 6/16/08
NDK405FA	DD404P	After 6/16/08
	DD405P	After 6/16/08
	DDT40-P	After 6/16/08
	DDT41P	After 6/16/08
NDK405R	19060-D	
	21060-D	
	22060-D	
	RD404	
	RD405	
NDK406	RD454	
	19055-D	
	19055-S	
	21065-D	

EATON KIT APPS BY KIT		
Kit	Axle Model	Comments
NDK406	21065-S	
	22065-D	
	22065-S	
NDK410	21080-D	
	21080-S	
	23080-D	
	23080-S	
	23085-D	
	23085-S	
	26080-D	
	26080-S	
NDK412	22120	
	22121	
	RA402	After 1/1/95
	RS341	After 1/1/95
	RS402	After 1/1/95
	RS403	After 1/1/95
NDK413	RS451	After 1/1/95
	44RS	w/ Casting #C67854 Before 2/1/79
	44RSM	
	3527	w/ 27950 Case
	19227	Before 2/1/79
	19327	
	19420	
	19426	
	23227	Before 2/1/79
	23327	w/ 103537 Case
	23420	After 2/1/79
NDK415	26420	
	26426	
	35227	w/ 27950 Case
NDK418	19100	
	20100	
	23121	GMC Trucks
NDK419	23054	
	26054	
	30054	
	35054	
NDK420	190C4	
	190P4	
	190T4	
	220C4	
	220P4	
	220T4	
NDK421	230C4	
	260C4	
	300C4	
	300P4	
	350C4	
	350P4	
	350T4	
NDK422	230P4	
	230T4	
	260P4	
	260T4	
NDK424	300T4	
	DS386P	
	DS406-P	
	DS3416-P	
NDK424	DS4026-P	
	DC386P	
NDK424	DC406-P	

EATON KIT APPS BY KIT		
Kit	Axle Model	Comments
NDK424	DC3416-P	
	DC4026-P	
	DP386P	
	DP406-P	
	DP3416-P	
	DP4026-P	
	DT386P	
	DT406-P	
	DT3416-P	
NDK426	DC4616-P	
	DC5216-P	
	DP446-P	
	DP466-P	
	DP4616-P	
	DP5216-P	
	DP6016-P	
	DP6516-P	
	DS446-P	w/ Traction Control
	DT446-P	
	DT466-P	
	DT4616-P	
	DT5216-P	
	DT6016-P	
DT6516-P		
NDK427	DDH44P	
	DSH40P	Before 6/16/08
	DSP40P	Before 6/16/08
NDK427A	DSP41P	Before 6/16/08
	DSH40P	After 6/16/08
	DSP40P	After 6/16/08
NDK428	DSP41P	After 6/16/08
	DDH40P	Before 6/16/08
	DDP40P	Before 6/16/08
NDK428A	DDP41P	Before 6/16/08
	DSH44P	
	DDH40P	After 6/16/08
NDK429	DDP40P	After 6/16/08
	DDP41P	After 6/16/08
	22060-SH	
	RDH44	
	RSH40	
	RSH44	
NDK430	RSP40	
	RSP41	
	RDH40	
NDK430	RDP40	
	RDP41	

EATON KIT APPS BY KIT			
Kit	Axle Model	Comments	
NDK431	DSS40P		
	DC461-P	After 2/2000	
	DC462-P	After 2/2000	
	DC463-P	After 2/2000	
	DC521-P	After 2/2000	
	DD461-P	After 2/2000	
	DD462-P	After 2/2000	
	DD463-P	After 2/2000	
	DD521-P	After 2/2000	
	DD581-P	After 2/2000	
	DD601P	After 2/2000	
	DD651P	After 2/2000	
	NDK432	DP461-P	After 2/2000
		DP462-P	After 2/2000
		DP463-P	After 2/2000
		DP521-P	After 2/2000
		DP601-P	After 2/2000
		DP651-P	After 2/2000
		DT461-P	After 2/2000
		DT462-P	After 2/2000
		DT463-P	After 2/2000
DT521-P		After 2/2000	
DT601-P		After 2/2000	
DT651-P		After 2/2000	
NDK433		DS461-P	After 2/2000
		DS462-P	After 2/2000
	DS463-P	After 2/2000	
	DS521-P	After 2/2000	
	DS581-P	After 2/2000	
NDK445	DS601P	After 2/2000	
	DS651-P	After 2/2000	
	RDT40		
	RDT41		
	RST40	Before 4/1/05 & 2.64-5.57 Ratios	
NDK449	RST41	Before 4/1/05 & 2.64-5.57 Ratios	
	RS461		
	RS462		
	RS463		
	RS521		
	RS581		
	RS601		
	RS651		
	RS4616		
	RS5216		
RS540			

FREIGHTLINER KIT APPS BY KIT		
Kit	Axle Model	Comments
NDK650F	ART-34-4	
	ART-40-4	
	ART-44-4	
NDK650R	ARS-17.5-4	
	ARS-19-4	
	ARS-20-4	
	ARS-23-4	
	ART-34-4	
	ART-40-4	
	ART-44-4	
NDK651	ARS-13-2	
	ARS-15-2	
	ARS-17.5-2	
	ARS-19-2	
	ARS-21-2	

MACK KIT APPS BY KIT		
Kit	Axle Model	Comments
NDK117	AWDR48	
	CRD78	
	CRD94	
	CRD116	w/ 11KHA4165, 4165A
	CRD117	w/ 11KHA4159API-AP14
	CRD117	w/ 11KHA45159CP12
	CRD118	
	CRD781	
	CRD1161	w/ 11KHA4159, 4159A, 4166, 4166A
	CRD1171	w/ 11KHA4159C, 4167B
	CRD1171	w/ 11KHA4167, 4167A
	RAD23	
	RAD305	
	RAD500	
	RAD501	
	RAD507	
	RAD508	
	RAD509	
	RAD512	
	RAD529	
	RAD529CW	
	RAD530	
	RAD530C	
	RAD606	
	RAD606C	
	RAD705	
	RAD5291	
	RADF1000	
	RADL529	
	RADL5291	
	RADP1001	
	RASS00	
	NDK117A	CRD116
CRD1161		Non-Current
CRD117		Non-Current
CRD1171		Non-Current
NDK205	CRD93	w/ 11KH5326, 5327, 5330
	CRD113	w/ 11KH5341, 5342
	CRDLP93	
	SW29	
	SW30	
NDK205A	CRD93	w/ 11KH5326, 5327, 5330
	CRD113	w/ 11KH5341, 5342
	CRDLP93	
	SW30	
	SW31	
NDK206	CRDLP92	w/ 11KH5312, 5313
	CRDLP92	w/ 11KH5313
	CRDLP92	w/ 11KH5316, 5317, 5318, 5319
	CRDPC112	w/ 11KH5333, 5334, 5336
	SWD32	

MACK KIT APPS BY KIT		
Kit	Axle Model	Comments
NDK206A	CRDLP92	w/ 11KH5312, 5313
	CRDLP92	w/ 11KH5313
	CRDLP92	w/ 11KH5316, 5317, 5318, 5319
	CRDPC112	w/ 11KH5333, 5334, 5336
NDK212F	SWD32	
	CRDP95	
	SS65	
	SW65	
	SW80	
	SWD69	
	SWD691	
	SWP801	
	SWS59	
	SWS92	
	SWS93	
	SWS592	
	SWW59	
	SWW69	
	SWW69W	
	SWW592	
SWWP95		
NDK212R	CRD96	
	SS65	
	SW65	
	SW80	
	SWD69	
	SWD691	
	SWP801	
	SWS59	
	SWS92	
	SWS93	
	SWW59	
	SWW69	
	SWW69W	
	SWW592	
	SWWP95	
	NDK500	CRDP200
CRD202		
NDK501	CRD201	
	CRD203	
NDK503	CRD93A	
NDK506	CRDP200	
NDK507	C150	
	C151	
	CRD150	
	CRD151	
	CRD1511	
	CRDPC150	
NDK508	CRDPC1501	
	C151	
	CRD151	
	CRD1511	

MERITOR KIT APPS BY KIT			
Kit	Axle Model	Carriers	Comments
NDK9F	ELHD		w/Ratios Above 4.63:1 & 1-3/16" I.D. Pinion Rear Bearing
	EQHD		w/Ratios Above 4.63:1 & 1-3/16" I.D. Pinion Rear Bearing
	ERLHD		w/Ratios Above 4.63:1 & 1-3/16" I.D. Pinion Rear Bearing
	ERQHD		w/Ratios Above 4.63:1 & 1-3/16" I.D. Pinion Rear Bearing
	ESQHD		w/Ratios Above 4.63:1 & 1-3/16" I.D. Pinion Rear Bearing
	SLHD		1-3/16" Pinion Bearing and Ratios above 4.63
	SLHD		From 1962 w/Ratios Above 4.63:1 & 1-3/16" I.D. Pinion Rear Bearing
	SLHD		w/Ratios Above 4.63:1 & 1-3/16" I.D. Pinion Rear Bearing
	SQHD		1-3/16" Pinion Bearing and Ratios above 4.63
	SQHD		From 1962 w/Ratios Above 4.63:1 & 1-3/16" I.D. Pinion Rear Bearing
	SQHD		w/Ratios Above 4.63:1 & 1-3/16" I.D. Pinion Rear Bearing
	NDK9R	ELHD	
EQHD			w/Ratios Above 4.63:1 & 1-3/16" I.D. Pinion Rear Bearing
ERLHD			w/Ratios Above 4.63:1 & 1-3/16" I.D. Pinion Rear Bearing
ERQHD			w/Ratios Above 4.63:1 & 1-3/16" I.D. Pinion Rear Bearing
ESQHD			w/Ratios Above 4.63:1 & 1-3/16" I.D. Pinion Rear Bearing
H120			1-3/16" Pinion Bearing and Ratios above 4.63
H120			Early w/ 1-3/16" I.D. Pinion Rear Bearing & Ratios Above 4.63:1
L100			1-3/16" Pinion Bearing and Ratios above 4.63
L100			Early w/ 1-3/16" I.D. Pinion Rear Bearing & Ratios Above 4.63:1
L100A			Early w/ 1-3/16" I.D. Pinion Rear Bearing & Ratios Above 4.63:1
L101			1-3/16" Pinion Bearing and Ratios above 4.63
L101			Early w/ 1-3/16" I.D. Pinion Rear Bearing & Ratios Above 4.63:1
L110			1-3/16" Pinion Bearing and Ratios above 4.63
L110			Early w/ 1-3/16" I.D. Pinion Rear Bearing & Ratios Above 4.63:1
L110A			1-3/16" Pinion Bearing and Ratios above 4.63
L110A			Early w/ 1-3/16" I.D. Pinion Rear Bearing & Ratios Above 4.63:1
NDK9RB	SLHD		1-3/16" Pinion Bearing and Ratios above 4.63
	SLHD		w/Ratios Above 4.63:1 & 1-3/16" I.D. Pinion Rear Bearing
	SQHD		1-3/16" Pinion Bearing and Ratios above 4.63
	SQHD		w/Ratios Above 4.63:1 & 1-3/16" I.D. Pinion Rear Bearing
	SQRHD		
	ELHD		w/Ratios Above 4.63:1 & 1-3/8 I.D. Pinion Rear Bearing
	EQHD		w/Ratios Above 4.63:1 & 1-3/8 I.D. Pinion Rear Bearing
ERLHD		w/Ratios Above 4.63:1 & 1-3/8 I.D. Pinion Rear Bearing	



MERITOR KIT APPS BY KIT			
Kit	Axle Model	Carriers	Comments
<b>NDK9RB</b>	ERQHD		w/Ratios Above 4.63:1 & 1-3/8 I.D. Pinion Rear Bearing
	ESQHD		w/Ratios Above 4.63:1 & 1-3/8 I.D. Pinion Rear Bearing
	H120		Ratios Above 4.63
	H120		Late w/ 1-3/8" I.D. Pinion Rear Bearing & Ratios Above 4.63:1
	L100		Ratios Above 4.63
	L100		Late w/ 1-3/8" I.D. Pinion Rear Bearing & Ratios Above 4.63:1
	L100A		Ratios Above 4.63
	L100A		1-3/16" Pinion Brg and Ratios Above 4.63
	L100A		Late w/ 1-3/8" I.D. Pinion Rear Bearing & Ratios Above 4.63:1
	L101		Ratios Above 4.63
	L101		Late w/ 1-3/8" I.D. Pinion Rear Bearing & Ratios Above 4.63:1
	L110		Ratios Above 4.63
	L110		Late w/ 1-3/8" I.D. Pinion Rear Bearing & Ratios Above 4.63:1
	L110A		Ratios Above 4.63
	L110A		Late w/ 1-3/8" I.D. Pinion Rear Bearing & Ratios Above 4.63:1
	SLHD		Ratios Above 4.63
	SLHD		w/Ratios Above 4.63:1 & 1-3/8 I.D. Pinion Rear Bearing
	SPR250		Ratios Above 4.63:1
	SPR400		Ratios Above 4.63:1
	SQHD		Ratios Above 4.63
SQHD		w/Ratios Above 4.63:1 & 1-3/8 I.D. Pinion Rear Bearing	
<b>NDK9RC</b>	ELHD		w/ Ratios of 4.63:1 & Below & 1-3/8" I.D. Pinions Rear Bearing
	EQHD		w/ Ratios of 4.63:1 & Below & 1-3/8" I.D. Pinions Rear Bearing
	ERLHD		w/ Ratios of 4.63:1 & Below & 1-3/8" I.D. Pinions Rear Bearing
	ERQHD		w/ Ratios of 4.63:1 & Below & 1-3/8" I.D. Pinions Rear Bearing
	ESQHD		w/ Ratios of 4.63:1 & Below & 1-3/8" I.D. Pinions Rear Bearing
	H120		3.55-4.63 Ratios
	H120		Late w/ 1-3/8" I.D. Pinion Rear Bearing & Ratios Above 4.63:1 & Below
	L100		3.55-4.63 Ratios
	L100		Late w/ 1-3/8" I.D. Pinion Rear Bearing & Ratios Above 4.63:1 & Below
	L100A		3.55-4.63 Ratios
	L100A		Late w/ 1-3/8" I.D. Pinion Rear Bearing & Ratios Above 4.63:1 & Below
	L101		3.55-4.63 Ratios
	L101		Late w/ 1-3/8" I.D. Pinion Rear Bearing & Ratios Above 4.63:1 & Below
	L110		3.55-4.63 Ratios
	L110		Late w/ 1-3/8" I.D. Pinion Rear Bearing & Ratios Above 4.63:1 & Below
	L110A		3.55-4.63 Ratios
	L110A		Late w/ 1-3/8" I.D. Pinion Rear Bearing & Ratios Above 4.63:1 & Below
	LT100		

MERITOR KIT APPS BY KIT			
Kit	Axle Model	Carriers	Comments
<b>NDK9RC</b>	SLHD		w/ Ratios of 4.63:1 & Below & 1-3/8" I.D. Pinions Rear Bearing
	SPR250		Ratios 4.63:1 and Below
	SPR400		Ratios Below 4.63:1
	SQHD		w/ Ratios of 4.63:1 & Below & 1-3/8" I.D. Pinions Rear Bearing
<b>NDK50</b>	not identified	R170	Exc. Ford from, ser 732,001
	not identified	R170	all except 7.40 ratio
	not identified	R171	Exc. Ford from, ser 732,001
	not identified	R173	Exc. Ford from, ser 732,001
	not identified	RL170	Exc. Ford from, ser 732,001
	not identified	S170	Exc. Ford from, ser 732,001
	not identified	SR170	
	not identified	SU170	
	not identified	SW170	
	not identified	W170	
	Out of Production Single Reduction Axles – Single	R170	Prior to 12/1/83 exc. 7.40 Ratio
	Out of Production Single Reduction Axles – Single	RL170	Prior to 12/1/83 exc. 7.40 Ratio
	Out of Production Single Reduction Axles – Single	S170	Prior to 12/1/83 exc. 7.40 Ratio
	Out of Production Single Reduction Axles – Single	W170	
Out of Production Single Reduction Axles – Tandem	SR170	All Ratios Exc. 7.40	
Out of Production Single Reduction Axles – Tandem	SU170	All Ratios Exc. 7.40	
Out of Production Single Reduction Axles – Tandem	SW170	All Ratios Exc. 7.40	
<b>NDK50A</b>	R170		W/Ford from ser 732,001
	R-170	B-3200-G605	Ford series 732, and up
	R171		
	R171		W/Ford from ser 732,001
	R173		
	R173		W/Ford from ser 732,001
	RL170		W/Ford from ser 732,001
	S170		W/Ford from ser 732,001
<b>NDK172F</b>	ESQHD		
<b>NDK172FA</b>	SSHHD		Ball Bearing Input & Output Shaft w/Involute Splines
	SSHHD		Late 1972-on
	SSHHD		Ball Bearing Input & Output Shaft w/Involute Splines
<b>NDK172FA</b>	STHD		Ball Bearing Input & Output Shaft w/Involute Splines
	STHD		Late 1972-on
	SUHD		Ball Bearing Input & Output Shaft w/Involute Splines
	SUHD		Late 1972-on

MERITOR KIT APPS BY KIT			
Kit	Axle Model	Carriers	Comments
NDK172FB	SSHHD		Taper Bearing Input & Output Shaft
	SSHHD		w/Involute Splines & Tapered Bearing on Output Shaft
	SSHHD		
	SSHHP		Taper Bearing Input & Output Shaft
	STHD		Taper Bearing Input & Output Shaft
	STHD		w/Involute Splines & Tapered Bearing on Output Shaft
	STHD		
	SUHD		Taper Bearing Input & Output Shaft
	SUHD		w/Involute Splines & Tapered Bearing on Output Shaft
	SUHD		Late for use w/3200-R-1162 or 300-R-1162
NDK172R	FDS1807	#3200H606	
	FDS1808	#3200G969	
	FDS2100	#3200G969	
	FDS2101	#3200H606	
	PL143		
	PL143		Late
	PR250		
	PR300		Late
	PR400		Late
	PR400N		Late
	PR500		
	PS300		Late
	PS300W		Late
	PS311		Late
	PS350		Late
	R100		
	R100		Late
	R100A		
	R100A		Late
	R101		Late
	R110		
	R110		Late
	R110A		Late
	R112		
	R112		Late
	R113		
	R113		Late
	R114		
	R114		Late
	R115		
R115		Late	
R120			
R120		Late	
R140			
R140		Late	
R141			
R141		Late	
R143			
R143		Late	
R155			

MERITOR KIT APPS BY KIT			
Kit	Axle Model	Carriers	Comments
NDK172R	R155		Late
	R164		Late
	RA101A		Late
	RT140		Late
	SSHHD		Early Style Seal
	SSHHD		
	SSHHP		Early Style Seal
	STHD		Early Style Seal
	STHD		
	SUHD		Early Style Seal
NDK194F	SL100		
	SL100		w/Carrier 3200R1032 (Malleable) & Carrier 3200L1078 (Aluminum)
	SL100P		
	SL100P		w/Carrier 3200R1032 (Malleable) & Carrier 3200L1078 (Aluminum)
	SQ100		
	SQ100		w/Carrier 3200R1032 (Malleable) & Carrier 3200L1078 (Aluminum)
	SQ100P		
	SQHP		
	SQR100		
	SQR100		w/Carrier 3200R1032 (Malleable) & Carrier 3200L1078 (Aluminum)
	SQR100P		
	SQR100P		w/Carrier 3200R1032 (Malleable) & Carrier 3200L1078 (Aluminum)
	NDK194R	SQHP	
SQHP			Original Design
NDK194RA	SQHP		
	SQHP		w/2" Dia Spline Pinion & Carrier #3200-Y-1039
NDK194RB	SL100		
	SL100		w/Carrier 3200N1314 (Malleable) & Carrier 3200T1346 (Aluminum)
	SL100P		
	SL100P		w/Carrier 3200N1314 (Malleable) & Carrier 3200T1346 (Aluminum)
	SLR100		
	SQ100		
	SQ100		w/Carrier 3200N1314 (Malleable) & Carrier 3200T1346 (Aluminum)
	SQ100P		
	SQ100P		w/Carrier 3200N1314 (Malleable) & Carrier 3200T1346 (Aluminum)
	SQR100		
	SQR100		w/Carrier 3200N1314 (Malleable) & Carrier 3200T1346 (Aluminum)
SQR100P			
NDK204F	SUDD	3200E1227	
	SUDD		From 6-77 w/Involute Splines
NDK204R	SR170	3200L1234	
	SUDD		From 6-77 w/Involute Splines
NDK216	210, 220, 224, 230 & 240 Series Single Axles	RS-15-210	All
	Not Identified	RS-17-220	
NDK216		RS-15-210	All
	RS-17-220		

MERITOR KIT APPS BY KIT				
Kit	Axle Model	Carriers	Comments	
NDK217F	MT-40-143	B1978	Prior to 11/93 w Original 39 Spline Input	
	MT-40-143	C1979	Prior to 11/93 w Original 39 Spline Input	
	MT-40-143	F1852	Prior to 11/93 w Original 39 Spline Input	
	MT-40-143	G1645	Prior to 11/93 w Original 39 Spline Input	
	MT-40-143	G1853	Prior to 11/93 w Original 39 Spline Input	
	MT-40-143	H1984	Prior to 11/93 w Original 39 Spline Input	
	MT-40-143	N1860	Prior to 11/93 w Original 39 Spline Input	
	MT-40-143	S1917	Prior to 11/93 w Original 39 Spline Input	
	MT-40-143	T1814	Prior to 11/93 w Original 39 Spline Input	
	MT-40-143	V1816	Prior to 11/93 w Original 39 Spline Input	
	MT-40-143	X1662	Prior to 11/93 w Original 39 Spline Input	
	RD/RP-17-145			before 11/93
	RD/RP-20-145	3200-F-1645, 3200-X-1662, 3200-T-1814, 3200-V-1816		(before 11/93)
	RD/RP-22-145	3200-F-1645, 3200-X-1662, 3200-T-1814, 3200-V-1816		(before 11/93)
	RT-34-144	B1978		Prior to 11/93 w Original 39 Spline Input
	RT-34-144	C1979		Prior to 11/93 w Original 39 Spline Input
	RT-34-144	F1852		Prior to 11/93 w Original 39 Spline Input
	RT-34-144	G1645		Prior to 11/93 w Original 39 Spline Input
	RT-34-144	G1853		Prior to 11/93 w Original 39 Spline Input
	RT-34-144	H1984		Prior to 11/93 w Original 39 Spline Input
	RT-34-144	N1860		Prior to 11/93 w Original 39 Spline Input
	RT-34-144	S1917		Prior to 11/93 w Original 39 Spline Input
	RT-34-144	T1814		Prior to 11/93 w Original 39 Spline Input
	RT-34-144	V1816		Prior to 11/93 w Original 39 Spline Input
	RT-34-144	X1662		Prior to 11/93 w Original 39 Spline Input
	RT-34-145	All		Prior to 11/93 w Original 39 Spline Input
	RT-35-145			before 11/93
	RT-38-144	C1979		Prior to 11/93 w Original 39 Spline Input
	RT-38-144	F1852		Prior to 11/93 w Original 39 Spline Input
	RT-38-144	G1645		Prior to 11/93 w Original 39 Spline Input
	RT-38-144	G1853		Prior to 11/93 w Original 39 Spline Input
	RT-38-144	H1984		Prior to 11/93 w Original 39 Spline Input
	RT-38-144	N1860		Prior to 11/93 w Original 39 Spline Input

MERITOR KIT APPS BY KIT				
Kit	Axle Model	Carriers	Comments	
NDK217F	RT-38-144	S1917	Prior to 11/93 w Original 39 Spline Input	
	RT-38-144	T1814	Prior to 11/93 w Original 39 Spline Input	
	RT-38-144	V1816	Prior to 11/93 w Original 39 Spline Input	
	RT-38-144	X1662	Prior to 11/93 w Original 39 Spline Input	
	RT-40-145	B1978		Prior to 11/93 w Original 39 Spline Input
	RT-40-145	C1979		Prior to 11/93 w Original 39 Spline Input
	RT-40-145	F1852		Prior to 11/93 w Original 39 Spline Input
	RT-40-145	G1645		Prior to 11/93 w Original 39 Spline Input
	RT-40-145	G1853		Prior to 11/93 w Original 39 Spline Input
	RT-40-145	H1984		Prior to 11/93 w Original 39 Spline Input
	RT-40-145	N1860		Prior to 11/93 w Original 39 Spline Input
	RT-40-145	S1917		Prior to 11/93 w Original 39 Spline Input
	RT-40-145	T1814		Prior to 11/93 w Original 39 Spline Input
	RT-40-145	V1816		Prior to 11/93 w Original 39 Spline Input
	RT-40-145	X1662		Prior to 11/93 w Original 39 Spline Input
	RT-40-145	3200-G-1645, 3200-X-1662, 3200-T-1814, 3200-V-1816		before 11/93
	RT-44-145	B1874		Prior to 11/93 w Original 39 Spline Input
	RT-44-145	D1876		Prior to 11/93 w Original 39 Spline Input
	RT-44-145	D1980		Prior to 11/93 w Original 39 Spline Input
	RT-44-145	J1986		Prior to 11/93 w Original 39 Spline Input
	RT-44-145	P1914		Prior to 11/93 w Original 39 Spline Input
	RT-44-145	3200-G-1645, 3200-X-1662, 3200-T-1814, 3200-V-1816		before 11/93
	RT-38-144	G1645		Prior to 11/93 w Original 39 Spline Input
	RT-38-144	G1853		Prior to 11/93 w Original 39 Spline Input
	RT-38-144	H1984		Prior to 11/93 w Original 39 Spline Input
	RT-38-144	N1860		Prior to 11/93 w Original 39 Spline Input
	RT-38-144	S1917		Prior to 11/93 w Original 39 Spline Input
	RT-38-144	T1814		Prior to 11/93 w Original 39 Spline Input
	RT-38-144	V1816		Prior to 11/93 w Original 39 Spline Input
	RT-38-144	X1662		Prior to 11/93 w Original 39 Spline Input
	RT-40-145	B1978		Prior to 11/93 w Original 39 Spline Input
	RT-40-145	C1979		Prior to 11/93 w Original 39 Spline Input
	RT-40-145	F1852		Prior to 11/93 w Original 39 Spline Input

MERITOR KIT APPS BY KIT			
Kit	Axle Model	Carriers	Comments
<b>NDK217F</b>	RT-40-145	G1645	Prior to 11/93 w Original 39 Spline Input
	RT-40-145	G1853	Prior to 11/93 w Original 39 Spline Input
	RT-40-145	H1984	Prior to 11/93 w Original 39 Spline Input
	RT-40-145	N1860	Prior to 11/93 w Original 39 Spline Input
	RT-40-145	S1917	Prior to 11/93 w Original 39 Spline Input
	RT-40-145	T1814	Prior to 11/93 w Original 39 Spline Input
	RT-40-145	V1816	Prior to 11/93 w Original 39 Spline Input
	RT-40-145	X1662	Prior to 11/93 w Original 39 Spline Input
	RT-40-145	3200-G-1645, 3200-X-1662, 3200-T-1814, 3200-V-1816	before 11/93
	RT-44-145	B1874	Prior to 11/93 w Original 39 Spline Input
	RT-44-145	D1876	Prior to 11/93 w Original 39 Spline Input
	RT-44-145	D1980	Prior to 11/93 w Original 39 Spline Input
	RT-44-145	J1986	Prior to 11/93 w Original 39 Spline Input
	RT-44-145	P1914	Prior to 11/93 w Original 39 Spline Input
	RT-44-145	3200-G-1645, 3200-X-1662, 3200-T-1814, 3200-V-1816	before 11/93
	<b>NDK217R</b>	RR-17-145	
RR-19-144		D1850	
RR-19-144		E1851	
RR-19-144		L1676	
RR-19-144		M1885	
RR-19-144		Q1785	
RR-19-144		S1865	
RR-20-140		3200-L-1676, 3200-Q-1785, 3200-S-1865	
RR-20-145		3200-L-1676, 3200-Q-1785, 3200-S-1865	
RR-22-145		3200-L-1676, 3200-Q-1785, 3200-S-1865,	
RS-16-141		All	
RS-17-141		All	
RS-17-144		D1850	
RS-17-144		E1851	
RS-17-144		L1676	
RS-17-144		M1885	
RS-17-144		Q1785	
RS-17-144		S1895	
RS-19-144		All	
RS-19-144		D1850	
RS-19-144		L1676	
RS-19-144		M1885	
RS-19-144		Q1785	
RS-19-144		S1895	
RS-19-145	All		
RS-19-145	E1851		

MERITOR KIT APPS BY KIT			
Kit	Axle Model	Carriers	Comments
<b>NDK217R</b>	RS-21-145	3200-L-1676, 3200-Q-1785, 3200-S-1865	
	RS-21-145	D1850	
	RS-21-145	E1851	
	RS-21-145	L1676	
	RS-21-145	M1885	
	RS-21-145	Q1785	
	RS-21-145	S1895	
	RT-34-144	D1850	
	RT-34-144	E1851	
	RT-34-144	L1676	
	RT-34-144	M1885	
	RT-34-144	Q1785	
	RT-34-144	S1865	
	RT-34-145	All	
	RT-40-140	3200-L-1676, 3200-Q-1785, 3200-S-1865	
	RT-40-140	All	
	RT-40-145	3200-L-1676, 3200-Q-1785, 3200-S-1865	
	RT-40-145	D1850	
	RT-40-145	E1851	
	RT-40-145	L1676	
RT-40-145	M1885		
RT-40-145	Q1785		
RT-40-145	S1865		
RT-44-145	3200-L-1676, 3200-Q-1785, 3200-S-1865		
RT-44-145	A1873		
<b>NDK218</b>	RS-13-120		
	RS-15-120		
	RS-15-125		
<b>NDK600</b>	QT140		
	QT140		Late
	QT143		
	QT143		Late
	QT145		
	QT145		Late
	QT148		
	QT148		Late
<b>NDK900F</b>	ELHD		w/Ratios Above & Below 4.63:1 & 1-3/8" I.D. Pinion Rear Bearing
	EQHD		w/Ratios Above & Below 4.63:1 & 1-3/8" I.D. Pinion Rear Bearing
	ERLHD		w/Ratios Above & Below 4.63:1 & 1-3/8" I.D. Pinion Rear Bearing
	ERQHD		w/Ratios Above & Below 4.63:1 & 1-3/8" I.D. Pinion Rear Bearing
	ESQHD		w/Ratios Above & Below 4.63:1 & 1-3/8" I.D. Pinion Rear Bearing
	SLHD		3.55-4.63 Ratios
	SLHD		From 1962 w/Ratios Above & Below 4.63:1 & 1-3/8" I.D. Pinion Rear Bearing
	SLHD		w/Ratios Above & Below 4.63:1 & 1-3/8" I.D. Pinion Rear Bearing
	SPR250		Ratios Above & Below 4.63:1
	SPR400		Ratios Above & Below 4.63:1
	SQHD		3.55-4.63 Ratios
	SQHD		From 1962 w/Ratios Above & Below 4.63:1 & 1-3/8" I.D. Pinion Rear Bearing
<b>NDK900F</b>	SQHD		w/Ratios Above & Below 4.63:1 & 1-3/8" I.D. Pinion Rear Bearing

MERITOR KIT APPS BY KIT			
Kit	Axle Model	Carriers	Comments
NDK900FA	ELHD		w/Ratios Above & Below 4.63:1 & 1- 3/8" I.D. Pinion Rear Bearing
	EQHD		w/Ratios Above & Below 4.63:1 & 1- 3/8" I.D. Pinion Rear Bearing
	ERLHD		w/Ratios Above & Below 4.63:1 & 1- 3/8" I.D. Pinion Rear Bearing
	ERQHD		w/Ratios Above & Below 4.63:1 & 1- 3/8" I.D. Pinion Rear Bearing
	ESQHD		w/Ratios Above & Below 4.63:1 & 1- 3/8" I.D. Pinion Rear Bearing
	SLHD		Ratios above 4.63
	SLHD		w/Ratios Above & Below 4.63:1 & 1- 3/8" I.D. Pinion Rear Bearing
	SPR250		
	SPR400		Ratios Above & Below 4.63:1
	SQHD		Ratios above 4.63
	SQHD		w/Ratios Above & Below 4.63:1 & 1- 3/8" I.D. Pinion Rear Bearing
	NDK2108	S9722	
S9723			
S9733			
NDK2111	C100		
	C102		
	C103		
NDK4095	SSHD		Taper Bearing Input & Output Shaft w/ Upgraded o/s seal
	SSHP		Taper Bearing Input & Output Shaft w/ Upgraded o/s seal
	STHD		Shaft w/Upgraded o/s seal
	SUHD		Taper Bearing Input & Output Shaft w/ Upgraded o/s seal
NDK4100	SSHD		Taper Bearing Input & Ball Bearing Output Shaft
	SSHD	3200-R-1162	
	SSHD	3200-M-1235 Carriers	
	SSHP		Taper Bearing Input & Ball Bearing Output Shaft
	STHD		Taper Bearing Input & Ball Bearing Output Shaft
	STHD	3200-R-1162	
	SUHD		Taper Bearing Input & Ball Bearing Output Shaft
	SUHD		
NDK4105	SSHD		Late Style Seal
	SSHP		Late Style Seal
	SUHD		Late Style Seal
NDK4125	SPR270	3200-J-1076, 3200-G-1255	7.40 Ratios Only
	SR170	3200-J-1076, 3200-G-1255	7.40 Ratios Only
	SR170	G1255	7.40 Ratios Only
	SR270	G1255	7.40 Ratios Only
	SR270	J1076	7.40 Ratios Only
	SR280	3200-J-1076, 3200-G-1255	7.40 Ratios Only
	SR280	G1255	7.40 Ratios Only
	SR280	J1076	7.40 Ratios Only
	SU170	3200-J-1076, 3200-G-1255	7.40 Ratios Only
	SU170	G1255	7.40 Ratios Only
	SU270	3200-J-1076, 3200-G-1255	7.40 Ratios Only
	SU270	G1255	7.40 Ratios Only
	SU270	J1076	7.40 Ratios Only

MERITOR KIT APPS BY KIT			
Kit	Axle Model	Carriers	Comments
NDK4125	SU280	3200-J-1076, 3200-G-1255	7.40 Ratios Only
	SU280	G1255	7.40 Ratios Only
	SU280	J1076	7.40 Ratios Only
	SW170	3200-J-1076, 3200-G-1255	7.40 Ratios Only
	SW170	G1255	7.40 Ratios Only
	SW170	J1076	7.40 Ratios Only
	SW270	3200-J-1076, 3200-G-1255	7.40 Ratios Only
	SW270	G1255	7.40 Ratios Only
	SW270	J1076	7.40 Ratios Only
	SW280	3200-J-1076, 3200-G-1255	
	SW280	G1255	7.40 Ratios Only
	SW280	J1076	7.40 Ratios Only
	NDK4130	R170	
R170		3200-G-605, 3200E-603	7.40 Ratios Only
RL170			Prior to 12/1/83 7.40 Ratio
S170			Prior to 12/1/83 7.40 Ratio
SR170			7.40 Ratios Only
SR170		3200-G-605, 3200-E-603	7.40 Ratios Only
SU170			7.40 Ratios Only
SU170		3200-G-605, 3200-E-603	7.40 Ratios Only
SW170			7.40 Ratios Only
SW170		3200-G-605, 3200-E-603	7.40 Ratios Only
NDK4135	SPR270	3200-X-1324	
	SR170	3200-X-1324	
	SR170	X1234	All Ratios Exc. 7.40
	SR270	X1324	All Ratios Exc. 7.40
	SR280	3200-X-1324	
	SR280	X1324	All Ratios Exc. 7.40
	SU170	3200-X-1324	
	SU170	X1234	All Ratios Exc. 7.40
	SU270	3200-X-1324	
	SU270	X1324	All Ratios Exc. 7.40
	SU280	3200-X-1324	
	SU280	X1324	All Ratios Exc. 7.40
	SW170	3200-X-1324	
	SW170	X1234	All Ratios Exc. 7.40
	SW270	3200-X-1324	
SW270	X1324	All Ratios Exc. 7.40	
SW280	3200-X-1324		
SW280	X1324	All Ratios Exc. 7.40	
NDK4140	SR170	M1625	All Ratios Exc. 7.40
	SR270	M1625	All Ratios Exc. 7.40
	SR280	M1625	All Ratios Exc. 7.40
	SU170	M1625	All Ratios Exc. 7.40
	SU270	M1625	All Ratios Exc. 7.40
	SU280	M1625	All Ratios Exc. 7.40
	SW170	M1625	All Ratios Exc. 7.40
	SW270	M1625	All Ratios Exc. 7.40
	SW280	M1625	All Ratios Exc. 7.40
	SW280	M1625	All Ratios Exc. 7.40
NDK4145	SPR270	3200-M-1625	7.40 Ratios Only
	SR170	3200-M-1625	7.40 Ratios Only
	SR170	M1625	7.40 Ratios Only
	SR270	M1625	7.40 Ratios Only
	SR280	3200-M-1625	7.40 Ratios Only
	SR280	M1625	7.40 Ratios Only

MERITOR KIT APPS BY KIT			
Kit	Axle Model	Carriers	Comments
NDK4145	SU170	3200-M-1625	7.40 Ratios Only
	SU170	M1625	7.40 Ratios Only
	SU270	3200-M-1625	7.40 Ratios Only
	SU270	M1625	7.40 Ratios Only
	SU280	3200-M-1625	7.40 Ratios Only
	SU280	M1625	7.40 Ratios Only
	SW170	3200-M-1625	7.40 Ratios Only
	SW170	M1625	7.40 Ratios Only
	SW270	3200-M-1625	7.40 Ratios Only
	SW270	M1625	7.40 Ratios Only
NDK4150	R170		12/1/83 & Later Exc. 7.40 Ratio
	RL170		12/1/83 & Later Exc. 7.40 Ratio
	S170		12/1/83 & Later Exc. 7.40 Ratio
NDK4155	SR270	M1625	All Ratios Exc. 7.40
	SR280	M1625	All Ratios Exc. 7.40
	SU270	M1625	All Ratios Exc. 7.40
	SU280	M1625	All Ratios Exc. 7.40
	SW270	M1625	All Ratios Exc. 7.40
	SW280	M1625	All Ratios Exc. 7.40
NDK4155A	SR270	M1625	7.40 Ratios Only
	SR280	M1625	7.40 Ratios Only
	SU270	M1625	7.40 Ratios Only
	SU280	M1625	7.40 Ratios Only
	SW270	M1625	7.40 Ratios Only
	SW280	M1625	7.40 Ratios Only
NDK4180	SQDD	3800E473	
	SQDD	3800H554	
NDK4310	F140		
	F140	3200-R-1110	
	F145		
	F145	3200-R-1110	
	F146		
	F146	3200-R-1110	
	F147		
	F147	3200-R-1110	
NDK4315	F105		
	F105	3200-R-1110	
	F106		
NDK4325	H170		
	H170	3200-N-924	
NDK4330	H172		
	H172	3200-Y-1091	
	H173		
	L172		
	L173		
	P174		
	Not Identified	H172	3200-Y-1091
	Out of Production Single Reduction Axles – Single	H172	
	Out of Production Single Reduction Axles – Single	H173	

MERITOR KIT APPS BY KIT			
Kit	Axle Model	Carriers	Comments
NDK4330	Out of Production Single Reduction Axles – Single	L172	
	Out of Production Single Reduction Axles – Single	L173	
	Out of Production Single Reduction Axles – Single	P174	
NDK4375	RS-15-210	All	
	RS-23-240	3200-F-1566	
NDK4390	RR-19-144	G1879	
	RR-19-144	X1558	
	RR-20-145	3200-M-1547, 3200-x-1558, 3200-G-1879	
	RR-22-145	3200-X-1558, 3200-G-1879	
	RS-17-144	G1879	
	RS-17-145	X1558	
	RS-19-144	G1879	
	RS-19-144	X1558	
	RS-21-145	3200-M-1547, 3200-x-1558, 3200-G-1879	
	RS-21-145	G1879	
	RS-21-145	X1558	
	RT-34-144	G1879	
	RT-34-144	X1558	
	RT-40-145	3200-M-1547, 3200-x-1558, 3200-G-1879	
	RT-40-145	G1879	
	RT-40-145	X1558	
RT-44-145	3200-M-1547, 3200-x-1558, 3200-G-1879		
RT-44-145	F1904		
NDK4395	MT-40-143	B1978	Prior to 11/93 w/ New 46 Spline Input
	MT-40-143	C1979	Prior to 11/93 w/ New 46 Spline Input
	MT-40-143	F1852	Prior to 11/93 w/ New 46 Spline Input
	MT-40-143	G1645	Prior to 11/93 w/ New 46 Spline Input
	MT-40-143	G1853	Prior to 11/93 w/ New 46 Spline Input
	MT-40-143	H1984	Prior to 11/93 w/ New 46 Spline Input
	MT-40-143	N1860	Prior to 11/93 w/ New 46 Spline Input
	MT-40-143	S1917	Prior to 11/93 w/ New 46 Spline Input
	MT-40-143	T1814	Prior to 11/93 w/ New 46 Spline Input
	MT-40-143	V1816	Prior to 11/93 w/ New 46 Spline Input
	MT-40-143	X1662	Prior to 11/93 w/ New 46 Spline Input
	RT-34-144	B1978	Prior to 11/93 w/ New 46 Spline Input



MERITOR KIT APPS BY KIT			
Kit	Axle Model	Carriers	Comments
NDK4395	RT-34-144	C1979	Prior to 11/93 w/ New 46 Spline Input
	RT-34-144	F1852	Prior to 11/93 w/ New 46 Spline Input
	RT-34-144	G1645	Prior to 11/93 w/ New 46 Spline Input
	RT-34-144	G1853	Prior to 11/93 w/ New 46 Spline Input
	RT-34-144	N1860	Prior to 11/93 w/ New 46 Spline Input
	RT-34-144	S1917	Prior to 11/93 w/ New 46 Spline Input
	RT-34-144	T1814	Prior to 11/93 w/ New 46 Spline Input
	RT-34-144	V1816	Prior to 11/93 w/ New 46 Spline Input
	RT-34-144	X1662	Prior to 11/93 w/ New 46 Spline Input
	RT-34-145	All	Prior to 11/93 w/ New 46 Spline Input
	RT-34-145	All	Prior to 11/93
	RT-38-144	B1978	Prior to 11/93 w/ New 46 Spline Input
	RT-38-144	C1979	Prior to 11/93 w/ New 46 Spline Input
	RT-38-144	F1852	Prior to 11/93 w/ New 46 Spline Input
	RT-38-144	G1645	Prior to 11/93 w/ New 46 Spline Input
	RT-38-144	G1853	Prior to 11/93 w/ New 46 Spline Input
	RT-38-144	H1984	Prior to 11/93 w/ New 46 Spline Input
	RT-38-144	N1860	Prior to 11/93 w/ New 46 Spline Input
	RT-38-144	S1917	Prior to 11/93 w/ New 46 Spline Input
	RT-38-144	T1814	Prior to 11/93 w/ New 46 Spline Input
	RT-38-144	V1816	Prior to 11/93 w/ New 46 Spline Input
	RT-38-144	X1662	Prior to 11/93 w/ New 46 Spline Input
	RT-40-145	B1978	Prior to 11/93 w/ New 46 Spline Input
	RT-40-145	C1979	Prior to 11/93 w/ New 46 Spline Input
	RT-40-145	F1852	Prior to 11/93 w/ New 46 Spline Input
	RT-40-145	G1645	Prior to 11/93 w/ New 46 Spline Input
	RT-40-145	G1853	Prior to 11/93 w/ New 46 Spline Input
	RT-40-145	H1984	Prior to 11/93 w/ New 46 Spline Input
	RT-40-145	N1860	Prior to 11/93 w/ New 46 Spline Input
	RT-40-145	S1917	Prior to 11/93 w/ New 46 Spline Input
	RT-40-145	T1814	Prior to 11/93 w/ New 46 Spline Input
	RT-40-145	V1816	Prior to 11/93 w/ New 46 Spline Input
	RT-40-145	X1662	Prior to 11/93 w/ New 46 Spline Input
	RT-44-145	B1874	Prior to 11/93 w/ New 46 Spline Input
	RT-44-145	D1876	Prior to 11/93 w/ New 46 Spline Input

MERITOR KIT APPS BY KIT				
Kit	Axle Model	Carriers	Comments	
NDK4395	RT-44-145	D1980	Prior to 11/93 w/ New 46 Spline Input	
	RT-44-145	J1986	Prior to 11/93 w/ New 46 Spline Input	
	RT-44-145	P1914	Prior to 11/93 w/ New 46 Spline Input	
NDK4396	MT-40-143	B1978	After 11/93	
	MT-40-143	C1979	After 11/93	
	MT-40-143	F1852	After 11/93	
	MT-40-143	G1645	After 11/93	
	MT-40-143	G1853	After 11/93	
	MT-40-143	H1984	After 11/93	
	MT-40-143	N1860	After 11/93	
	MT-40-143	S1917	After 11/93	
	MT-40-143	T1814	After 11/93	
	MT-40-143	V1816	After 11/93	
	MT-40-143	X1662	After 11/93	
	RD/RP-17-145			After 11/93
	RD/RP-20-145	3200-F-1645, 3200-X-1662, 3200-T-1814, 3200-V-1816		After 11/93
	RD/RP-22-145	3200-F-1645, 3200-X-1662, 3200-T-1814, 3200-V-1816		After 11/93
	RT-34-144	B1978	After 11/93	
	RT-34-144	C1979	After 11/93	
	RT-34-144	F1852	After 11/93	
	RT-34-144	G1645	After 11/93	
	RT-34-144	G1853	After 11/93	
	RT-34-144	H1984	Prior to 11/93 w/ New 46 Spline Input	
	RT-34-144	H1984	After 11/93	
	RT-34-144	N1860	After 11/93	
	RT-34-144	S1917	After 11/93	
	RT-34-144	T1814	After 11/93	
	RT-34-144	V1816	After 11/93	
	RT-34-144	X1662	After 11/93	
	RT-34-145	All	After 11/93	
	RT-34-145	All	After 11/93	
	RT-38-144	B1978	After 11/93	
	RT-38-144	C1979	After 11/93	
	RT-38-144	F1852	After 11/93	
	RT-38-144	G1645	After 11/93	
	RT-38-144	G1853	After 11/93	
	RT-38-144	H1984	After 11/93	
	RT-38-144	N1860	After 11/93	
	RT-38-144	S1917	After 11/93	
	RT-38-144	T1814	After 11/93	
	RT-38-144	V1816	After 11/93	
	RT-38-144	X1662	After 11/93	
	RT-40-145	3200-G-1645, 3200-X-1662, 3200-T-1814, 3200-V-1816		After 11/93
	RT-40-145	B1978	After 11/93	
	RT-40-145	C1979	After 11/93	
RT-40-145	F1852	After 11/93		
RT-40-145	G1645	After 11/93		
RT-40-145	G1853	After 11/93		
RT-40-145	H1984	After 11/93		
RT-40-145	N1860	After 11/93		

MERITOR KIT APPS BY KIT			
Kit	Axle Model	Carriers	Comments
NDK4396	RT-40-145	S1917	After 11/93
	RT-40-145	T1814	After 11/93
	RT-40-145	V1816	After 11/93
	RT-40-145	X1662	After 11/93
	RT-44-145	3200-G-1645, 3200-X-1662, 3200-T-1814, 3200-V-1816	After 11/93
	RT-44-145	B1874	After 11/93
	RT-44-145	D1876	After 11/93
	RT-44-145	D1980	After 11/93
	RT-44-145	J1986	After 11/93
	RT-44-145	P1914	After 11/93
NDK4400	RR-17-145		
	RR-19-144	D1850	
	RR-19-144	E1851	
	RR-19-144	L1676	
	RR-19-144	M1885	
	RR-19-144	Q1785	
	RR-19-144	S1865	
	RR-20-140	3200-L-1676, 3200-Q-1785, 3200-S-1865	
	RR-20-145	3200-L-1676, 3200-Q-1785, 3200-S-1865	
	RR-22-145	3200-L-1676, 3200-Q-1785, 3200-S-1865	
	RS-16-141	All	
	RS-17-141	All	
	RS-17-144	D1850	
	RS-17-144	E1851	
	RS-17-144	L1676	
	RS-17-144	M1885	
	RS-17-144	Q1785	
	RS-17-144	S1895	
	RS-19-144	All	
	RS-19-144	D1850	
	RS-19-144	L1676	
	RS-19-144	M1885	
	RS-19-144	Q1785	
	RS-19-144	S1895	
	RS-19-145	All	
	RS-19-145	E1851	
	RS-21-145	3200-L-1676, 3200-Q-1785, 3200-S-1865	
	RS-21-145	D1850	
	RS-21-145	E1851	
	RS-21-145	L1676	
	RS-21-145	M1885	
	RS-21-145	Q1785	
	RS-21-145	S1895	
	RT-34-144	D1850	
	RT-34-144	E1851	
	RT-34-144	L1676	
	RT-34-144	M1885	
	RT-34-144	Q1785	
	RT-34-144	S1865	
	RT-34-145	All	
	RT-40-140	3200-L-1676, 3200-Q-1785, 3200-S-1865	

MERITOR KIT APPS BY KIT			
Kit	Axle Model	Carriers	Comments
NDK4400	RT-40-140	All	
	RT-40-145	3200-L-1676, 3200-Q-1785, 3200-S-1865	
	RT-40-145	D1850	
	RT-40-145	E1851	
	RT-40-145	L1676	
	RT-40-145	M1885	
	RT-40-145	Q1785	
	RT-40-145	S1865	
	RT-44-145	3200-L-1676, 3200-Q-1785, 3200-S-1865	
	RT-44-145	A1873	
NDK4405	MT-40-143	D1902	Prior to 11/93
	MT-40-143	E1903	Prior to 11/93
	MT-40-143	E1981	Prior to 11/93
	MT-40-143	K1984	Prior to 11/93
	MT-40-143	L1624	Prior to 11/93
	MT-40-143	M1677	Prior to 11/93
	MT-40-143	P1888	Prior to 11/93
	MT-40-143	R1890	Prior to 11/93
	MT-40-143	R1890	After 11/93
	MT-40-143	U1815	Prior to 11/93
	MT-40-143	W1817	Prior to 11/93
	RD/RP-20-145	3200-L-1624, 3200-M-1677, 3200-P-1888, 3200-R1890, 3200-D-1902	Prior to 11/93
	RD/RP-22-145	3200-L-1624, 3200-M-1677, 3200-P-1888, 3200-R1890, 3200-D-1902	Prior to 11/93
	RT-34-144	D1902	Prior to 11/93
	RT-34-144	E1903	Prior to 11/93
	RT-34-144	E1981	Prior to 11/93
	RT-34-144	K1987	Prior to 11/93
	RT-34-144	L1624	Prior to 11/93
	RT-34-144	M1677	Prior to 11/93
	RT-34-144	P1888	Prior to 11/93
	RT-34-144	R1890	Prior to 11/93
	RT-34-144	U1815	Prior to 11/93
	RT-34-144	W1817	Prior to 11/93
	RT-38-144	D1902	Prior to 11/93
	RT-38-144	E1903	Prior to 11/93
	RT-38-144	E1981	Prior to 11/93
	RT-38-144	K1987	Prior to 11/93
	RT-38-144	L1624	Prior to 11/93
	RT-38-144	M1677	Prior to 11/93
	RT-38-144	P1888	Prior to 11/93
	RT-38-144	R1890	Prior to 11/93
	RT-38-144	U1815	Prior to 11/93
	RT-38-144	W1817	Prior to 11/93
	RT-40-145	3200-L-1624, 3200-M-1677, 3200-P-1888, 3200R-1890, 3200-D-1902	Prior to 11/93
	RT-40-145	D1902	Prior to 11/93
	RT-40-145	E1903	Prior to 11/93
	RT-40-145	E1981	Prior to 11/93
	RT-40-145	K1987	Prior to 11/93
	RT-40-145	L1624	Prior to 11/93

MERITOR KIT APPS BY KIT			
Kit	Axle Model	Carriers	Comments
NDK4405	RT-40-145	M1677	Prior to 11/93
	RT-40-145	M1677	After 11/93
	RT-40-145	P1888	Prior to 11/93
	RT-40-145	R1890	Prior to 11/93
	RT-40-145	U1815	Prior to 11/93
	RT-40-145	W1817	Prior to 11/93
	RT-44-145	3200-L-1624, 3200-M-1677, 3200-P-1888, 3200R-1890, 3200-D-1902	Prior to 11/93
	RT-44-145	C1875	Prior to 11/93
	RT-44-145	E1877	Prior to 11/93
	RT-44-145	F1982	Prior to 11/93
	RT-44-145	G1905	Prior to 11/93
	RT-44-145	H1906	Prior to 11/93
	RT-44-145	M1911	Prior to 11/93
	RT-44-145	T1918	Prior to 11/93
NDK4406	MT-40-143	D1902	After 11/93
	MT-40-143	E1903	After 11/93
	MT-40-143	E1981	After 11/93
	MT-40-143	K1987	After 11/93
	MT-40-143	L1624	After 11/93
	MT-40-143	M1677	After 11/93
	MT-40-143	P1888	After 11/93
	MT-40-143	U1815	After 11/93
	MT-40-143	W1817	After 11/93
	RD/RP-20-145	3200-L-1624, 3200-M-1677, 3200-P-1888, 3200-R1890, 3200-D-1902	After 11/93
	RD/RP-22-145	3200-L-1624, 3200-M-1677, 3200-P-1888, 3200-R1890, 3200-D-1902	After 11/93
	RT-34-144	D1902	After 11/93
	RT-34-144	E1903	After 11/93
	RT-34-144	E1981	After 11/93
	RT-34-144	K1987	After 11/93
	RT-34-144	L164	After 11/93
	RT-34-144	M1677	After 11/93
	RT-34-144	P1888	After 11/93
	RT-34-144	R1890	After 11/93
	RT-34-144	U1815	After 11/93
	RT-34-144	W1817	After 11/93
	RT-38-144	D1902	After 11/93
	RT-38-144	E1903	After 11/93
	RT-38-144	E1981	After 11/93
	RT-38-144	K1987	After 11/93
	RT-38-144	L1624	After 11/93
	RT-38-144	M1677	After 11/93
	RT-38-144	P1888	After 11/93
	RT-38-144	R1890	After 11/93
	RT-38-144	U1815	After 11/93
	RT-38-144	W1817	After 11/93
	RT-40-145	3200-L-1624, 3200-M-1677, 3200-P-1888, 3200R-1890, 3200-D-1902	After 11/93
	RT-40-145	D1902	After 11/93
	RT-40-145	E1903	After 11/93
	RT-40-145	E1981	After 11/93

MERITOR KIT APPS BY KIT			
Kit	Axle Model	Carriers	Comments
NDK4406	RT-40-145	K1987	After 11/93
	RT-40-145	L1624	After 11/93
	RT-40-145	P1888	After 11/93
	RT-40-145	R1890	After 11/93
	RT-40-145	U1815	After 11/93
	RT-40-145	W1817	After 11/93
	RT-44-145	3200-L-1624, 3200-M-1677, 3200-P-1888, 3200R-1890, 3200-D-1902	After 11/93
	RT-44-145	C1875	After 11/93
	RT-44-145	E1877	After 11/93
	RT-44-145	F1982	After 11/93
	RT-44-145	G1905	After 11/93
	RT-44-145	H1906	After 11/93
	RT-44-145	M1911	After 11/93
	RT-44-145	T1918	After 11/93
NDK4415	RC-23-160	C1511	
	RC-23-160	T1658	
	RC-23-160	V1660	
	RC-23-160	Z1560	
	RR/RS-23-160	3200-C-1511, 3200-Z-1560, 3200-T-1658, 3200-V-1660	
	RR/RS-26-160	3200-C-1511, 3200-Z-1560, 3200-T-1658, 3200-V-1660	
	RS-20-160	C1511	
	RS-20-160	T1658	
	RS-20-160	V1660	
	RS-20-160	Z1560	
	RS-21-160	C1511	
	RS-21-160	T1658	
	RS-21-160	V1660	
	RS-21-160	Z1560	
	RS-23-160	C1511	
	RS-23-160	T1658	
	RS-23-160	V1660	
	RS-23-160	Z1560	
	RS-23-161	3200-C-1511, 3200-Z-1560, 3200-T-1658, 3200-V-1660	
	RS-23-161	C1511	
	RS-23-161	T1658	
	RS-23-161	V1660	
	RS-23-161	Z1560	
	RS-24-160	C1511	
	RS-24-160	T1658	
	RS-24-160	V1660	
	RS-24-160	Z1560	
	RS-25-160	C1511	
	RS-25-160	T1658	
	RS-25-160	V1660	
	RS-25-160	Z1560	
	RS-26-160	C1511	
RS-26-160	T1658		
RS-26-160	V1660		
RS-26-160	Z1560		
RT-40-160	C1511		
RT-40-160	T1658		

MERITOR KIT APPS BY KIT			
Kit	Axle Model	Carriers	Comments
<b>NDK4415</b>	RT-40-160	V1660	
	RT-40-160	Z1560	
	RT-46-160	3200-C-1511, 3200-Z-1560, 3200-T-1658, 3200-V-1660	
	RT-46-160	C1511	
	RT-46-160	T1658	
	RT-46-160	V1660	
	RT-46-160	Z1560	
	RT-46-164	C1511	
	RT-46-164	T1658	
	RT-46-164	V1660	
	RT-46-164	Z1560	
	RT-50-160	C1511	
	RT-50-160	T1658	
	RT-50-160	V1660	
	RT-50-160	Z1560	
	RT-50-164	C1511	
	RT-50-164	T1658	
	RT-50-164	V1660	
	RT-50-164	Z1560	
	RT-52-160	3200-C-1511, 3200-Z-1560, 3200-T-1658, 3200-V-1660	
	RT-52-160	C1511	
	RT-52-160	T1658	
	RT-52-160	V1660	
	RT-52-160	Z1560	
	RT-52-164	C1511	
	RT-52-164	T1658	
	RT-52-164	V1660	
	RT-52-164	Z1560	
<b>NDK4420</b>	RD/RP-23-160	3200-P-1628, 3200-J-1648	
	RD/RP-26-160	3200-P-1628, 3200-J-1648	
	RT-40-160	J1648	
	RT-40-160	P1628	
	RT-46-160	3200-P-1628, 3200-J-1648	
	RT-46-160	J1648	
	RT-46-160	P1628	
	RT-46-164	J1648	
	RT-46-164	P1628	
	RT-50-160	J1648	
	RT-50-160	P1628	
	RT-50-164	J1648	
	RT-50-164	P1628	
	RT-52-160	3200-P-1628, 3200-J-1648	
	RT-52-160	J1648	
	RT-52-160	P1628	
	RT-52-164	J1648	
	RT-52-164	P1628	
<b>NDK4422</b>	RD/RP-23-160	3200-K-1701, 3200-M-1703, 3200-X-1818, 3200-Z-1820, 3200-V-1894	
	RD/RP-26-160	3200-K-1701, 3200-M-1703, 3200-X-1818, 3200-Z-1820, 3200-V-1894	

MERITOR KIT APPS BY KIT			
Kit	Axle Model	Carriers	Comments
<b>NDK4422</b>	RT-40-160	J2116	
	RT-40-160	K1857	
	RT-40-160	M1703	
	RT-40-160	Q1837	
	RT-40-160	X1818	
	RT-46-160	3200-K-1701, 3200-M-1703, 3200-X-1818, 3200-Z-1820, 3200-V-1894	
	RT-46-160	J2116	
	RT-46-160	K1857	
	RT-46-160	M1703	
	RT-46-160	Q1837	
	RT-46-160	X1818	
	RT-46-164	J2116	
	RT-46-164	K1857	
	RT-46-164	M1703	
	RT-46-164	Q1837	
	RT-46-164	X1818	
	RT-50-160	J2116	
	RT-50-160	K1857	
	RT-50-160	M1703	
	RT-50-160	Q1837	
	RT-50-160	X1818	
	RT-50-164	J2116	
	RT-50-164	K1857	
	RT-50-164	M1703	
	RT-50-164	Q1837	
	RT-50-164	X1818	
	RT-52-160	3200-K-1701, 3200-M-1703, 3200-X-1818, 3200-Z-1820, 3200-V-1894	
	RT-52-160	J2116	
	RT-52-160	K1857	
	RT-52-160	M1703	
	RT-52-160	Q1837	
	RT-52-160	X1818	
RT-52-164	J2116		
RT-52-164	K1857		
RT-52-164	M1703		
RT-52-164	Q1837		
RT-52-164	X1818		
<b>NDK4423</b>	RD/RP-23-160	3200-W-1713, 3200-Y-1819, 3200-W-1895	
	RD/RP-26-160	3200-W-1713, 3200-Y-1819, 3200-W-1895	
	RT-40-160	K1701	
	RT-40-160	K2117	
	RT-40-160	L2118	
	RT-40-160	V1894	
	RT-40-160	W1713	
	RT-40-160	W1895	
	RT-40-160	Y1819	
	RT-40-160	Z1820	
	RT-46-160	3200-W-1713, 3200-Y-1819, 3200-W-1895	
	RT-46-160	K1701	
RT-46-160	K2117		

MERITOR KIT APPS BY KIT			
Kit	Axle Model	Carriers	Comments
NDK4423	RT-46-160	L2118	
	RT-46-160	V1894	
	RT-46-160	W1713	
	RT-46-160	W1895	
	RT-46-160	Y1819	
	RT-46-160	Z1820	
	RT-46-164	K1701	
	RT-46-164	K2117	
	RT-46-164	L2118	
	RT-46-164	V1894	
	RT-46-164	W1713	
	RT-46-164	W1895	
	RT-46-164	Y1819	
	RT-46-164	Z1820	
	RT-50-160	K1701	
	RT-50-160	K2117	
	RT-50-160	L2118	
	RT-50-160	V1894	
	RT-50-160	W1713	
	RT-50-160	W1895	
	RT-50-160	Y1819	
	RT-50-160	Z1820	
	RT-50-164	K1701	
	RT-50-164	K2117	
	RT-50-164	L2118	
	RT-50-164	V1894	
	RT-50-164	W1713	
	RT-50-164	W1895	
	RT-50-164	Y1819	
	RT-50-164	Z1820	
	RT-52-160	3200-W-1713, 3200-Y-1819, 3200-W-1895	
	RT-52-160	K1701	
	RT-52-160	K2117	
	RT-52-160	L2118	
	RT-52-160	V1894	
	RT-52-160	W1713	
	RT-52-160	W1895	
	RT-52-160	Y1819	
	RT-52-160	Z1820	
	RT-52-164	K1701	
	RT-52-164	K2117	
	RT-52-164	L2118	
RT-52-164	V1894		
RT-52-164	W1713		
RT-52-164	W1895		
RT-52-164	Y1819		
RT-52-164	Z1820		
NDK4426	RC-23-160	A1821	
	RC-23-160	H1854	
	RC-23-160	J1856	
	RC-23-160	P1706	
	RR/RS-23-160	3200-P-1706	
	RR/RS-26-160	3200-P-1706	
	RS-20-160	A1821	
	RS-20-160	H1854	
	RS-20-160	J1856	
	RS-20-160	P1706	
	RS-21-160	A1821	
	RS-21-160	H1854	
RS-21-160	J1856		

MERITOR KIT APPS BY KIT			
Kit	Axle Model	Carriers	Comments
NDK4426	RS-21-160	P1706	
	RS-23-160	A1821	
	RS-23-160	H1854	
	RS-23-160	J1856	
	RS-23-160	P1706	
	RS-23-161	3200-P-1706	
	RS-23-161	A1821	
	RS-23-161	H1854	
	RS-23-161	J1856	
	RS-23-161	P1706	
	RS-24-160	A1821	
	RS-24-160	H1854	
	RS-24-160	J1856	
	RS-24-160	P1706	
	RS-25-160	A1821	
	RS-25-160	H1854	
	RS-25-160	J1856	
	RS-25-160	P1706	
	RS-26-160	A1821	
	RS-26-160	H1854	
	RS-26-160	J1856	
	RS-26-160	P1706	
	RT-40-160	A1821	
	RT-40-160	H1854	
	RT-40-160	J1856	
	RT-40-160	P1706	
	RT-46-160	3200-P-1706	
	RT-46-160	A1821	
	RT-46-160	H1854	
	RT-46-160	J1856	
	RT-46-160	P1706	
	RT-46-164	A1821	
	RT-46-164	H1854	
	RT-46-164	J1856	
	RT-46-164	P1706	
	RT-50-160	A1821	
	RT-50-160	H1854	
	RT-50-160	J1856	
	RT-50-160	P1706	
	RT-50-164	A1821	
	RT-50-164	H1854	
	RT-50-164	J1856	
RT-50-164	P1706		
RT-52-160	3200-P-1706		
RT-52-160	A1821		
RT-52-160	H1854		
RT-52-160	J1856		
RT-52-160	P1706		
RT-52-164	A1821		
RT-52-164	H1854		
RT-52-164	J1856		
RT-52-164	P1706		
NDK4428	RC-23-160	C1823	
	RC-23-160	D1928	
	RC-23-160	E1825	
	RC-23-160	E1929	
	RC-23-160	R1708	
	RC-23-160	T1892	
	RC-23-160	V1712	
	RC-23-160	Y1897	

MERITOR KIT APPS BY KIT			
Kit	Axle Model	Carriers	Comments
<b>NDK4428</b>	RR/RS-23-160	3200-R-1708, 3200-V-1712, 3200-C-1823, 3200-E-1825, 3200-T-1892, 3200-Y-1897	
	RR/RS-26-160	3200-R-1708, 3200-V-1712, 3200-C-1823, 3200-E-1825, 3200-T-1892, 3200-Y-1897	
	RS-20-160	C1823	
	RS-20-160	D1928	
	RS-20-160	E1825	
	RS-20-160	E1929	
	RS-20-160	R1708	
	RS-20-160	T1892	
	RS-20-160	V1712	
	RS-20-160	Y1897	
	RS-21-160	C1823	
	RS-21-160	D1928	
	RS-21-160	E1825	
	RS-21-160	E1929	
	RS-21-160	P1708	
	RS-21-160	T1892	
	RS-21-160	V1712	
	RS-21-160	Y1897	
	RS-23-160	C1823	
	RS-23-160	D1928	
	RS-23-160	E1825	
	RS-23-160	E1929	
	RS-23-160	R1708	
	RS-23-160	T1892	
	RS-23-160	V1712	
	RS-23-160	Y1897	
	RS-23-161	3200-R-1708, 3200-V-1712, 3200-C-1823, 3200-E-1825, 3200-T-1892, 3200-Y-1897	
	RS-23-161	C1823	
	RS-23-161	D1928	
	RS-23-161	E1825	
	RS-23-161	E1929	
	RS-23-161	R1708	
	RS-23-161	T1892	
	RS-23-161	V1712	
	RS-23-161	Y1897	
	RS-24-160	C1823	
	RS-24-160	D1928	
	RS-24-160	E1825	
	RS-24-160	E1929	
	RS-24-160	R1708	
	RS-24-160	T1892	
	RS-24-160	V1712	
	RS-24-160	Y1897	
	RS-25-160	C1823	
	RS-25-160	D1928	
	RS-25-160	E1825	
	RS-25-160	E1929	
	RS-25-160	R1708	
	RS-25-160	T1892	
	RS-25-160	V1712	

MERITOR KIT APPS BY KIT			
Kit	Axle Model	Carriers	Comments
<b>NDK4428</b>	RS-25-160	Y1897	
	RS-26-160	C1823	
	RS-26-160	D1928	
	RS-26-160	E1825	
	RS-26-160	E1929	
	RS-26-160	R1708	
	RS-26-160	T1892	
	RS-26-160	V1712	
	RS-26-160	Y1897	
	RT-40-160	C1823	
	RT-40-160	D1928	
	RT-40-160	E1825	
	RT-40-160	E1929	
	RT-40-160	R1708	
	RT-40-160	T1892	
	RT-40-160	V1712	
	RT-40-160	Y1897	
	RT-46-160	3200-R-1708, 3200-V-1712, 3200-C-1823, 3200-E-1825, 3200-T-1892, 3200-Y-1897	
	RT-46-160	C1823	
	RT-46-160	D1928	
	RT-46-160	E1825	
	RT-46-160	E1929	
	RT-46-160	R1708	
	RT-46-160	T1892	
	RT-46-160	V1712	
	RT-46-160	Y1897	
	RT-46-164	C1823	
	RT-46-164	D1928	
	RT-46-164	E1825	
	RT-46-164	E1929	
	RT-46-164	R1708	
	RT-46-164	T1892	
	RT-46-164	V1712	
	RT-46-164	Y1897	
	RT-50-160	C1823	
	RT-50-160	D1928	
	RT-50-160	E1825	
	RT-50-160	E1929	
	RT-50-160	R1708	
	RT-50-160	T1892	
	RT-50-160	V1712	
	RT-50-160	Y1897	
	RT-50-164	C1823	
	RT-50-164	D1928	
	RT-50-164	E1825	
	RT-50-164	E1929	
	RT-50-164	R1708	
	RT-50-164	T1892	
	RT-50-164	V1712	
	RT-50-164	Y1897	
RT-52-160	3200-R-1708, 3200-V-1712, 3200-C-1823, 3200-E-1825, 3200-T-1892, 3200-Y-1897		
RT-52-160	C1823		
RT-52-160	D1928		
RT-52-160	E1825		



MERITOR KIT APPS BY KIT				
Kit	Axle Model	Carriers	Comments	
<b>NDK4428</b>	RT-52-160	E1929		
	RT-52-160	R1708		
	RT-52-160	T1892		
	RT-52-160	V1712		
	RT-52-160	Y1897		
	RT-52-164	C1823		
	RT-52-164	D1928		
	RT-52-164	E1825		
	RT-52-164	E1929		
	RT-52-164	R1708		
	RT-52-164	T1892		
	RT-52-164	V1712		
<b>NDK4435</b>	RR-24-180	3200-U-1399	All except 6.83, 7.17 & 7.40	
	RR-26-180	3200-U-1399	All except 6.83, 7.17 & 7.41	
	RR-29-180	3200-U-1399	All except 6.83, 7.17 & 7.42	
	RS-23-180	3200-U-1399	All except 6.83, 7.17 & 7.40	
	RS-23-180	C1381	All Other Ratios	
	RS-23-180	K1753	All Other Ratios	
	RS-23-180	U1399	All Other Ratios	
	RS-23-185	C1381	All Other Ratios	
	RS-23-185	K1753	All Other Ratios	
	RS-23-185	U1399	All Other Ratios	
	RS-23-186	C1381	All Other Ratios	
	RS-23-186	K1753	All Other Ratios	
	RS-23-186	U1399	All Other Ratios	
	RS-26-180	C1381	All Other Ratios	
	RS-26-180	U1399	All Other Ratios	
	RS-26-185	C1381	All Other Ratios	
	RS-26-185	U1399	All Other Ratios	
	RS-30-180	K1753	All Other Ratios	
	RS-30-180	U1399	All Other Ratios	
	RS-30-185	C1381	All Other Ratios	
	RS-30-185	K1753	All Other Ratios	
	RS-30-185	U1399	All Other Ratios	
	RT-48-180	3200-U-1399	All except 6.83, 7.17 & 7.40	
	RT-48-180	C1381	All Other Ratios	
	RT-48-180	U1399	All Other Ratios	
	RT-48-185	C1381	All Other Ratios	
	RT-48-185	U1399	All Other Ratios	
	RT-52-180	3200-U-1399	All except 6.83, 7.17 & 7.40	
	RT-52-180	C1381	All Other Ratios	
	RT-52-180	U1399	All Other Ratios	
	RT-52-185	C1381	All Other Ratios	
	RT-52-185	U1399	All Other Ratios	
	RT-58-180	3200-U-1399 (All except 6.83, 7.17 & 7.40)		
	RT-58-180	C1381	All Other Ratios	
	RT-58-180	U1399	All Other Ratios	
	<b>NDK4436</b>	RR-24-180	3200-U-1399	6.83, 7.17 & 7.40 Ratios
		RR-26-180	3200-U-1399	6.83, 7.17 & 7.40 Ratios
		RR-29-180	3200-U-1399	6.83, 7.17 & 7.40 Ratios
		RS-23-180	3200-U-1399	6.83, 7.17 & 7.40 Ratios
		RS-23-180	C1381	6.83, 7.17, 7.40 & 7.83 Ratios
RS-23-180		K1753	6.83, 7.17, 7.40 & 7.83 Ratios	
RS-23-180		U1399	6.83, 7.17, 7.40 & 7.83 Ratios	
RS-23-185		C1381	6.83, 7.17, 7.40 & 7.83 Ratios	
RS-23-185		K1753	6.83, 7.17, 7.40 & 7.83 Ratios	
RS-23-185		U1399	6.83, 7.17, 7.40 & 7.83 Ratios	
RS-23-186		C1381	6.83, 7.17, 7.40 & 7.83 Ratios	
RS-23-186		K1753	6.83, 7.17, 7.40 & 7.83 Ratios	

MERITOR KIT APPS BY KIT			
Kit	Axle Model	Carriers	Comments
<b>NDK4436</b>	RS-23-186	U1399	6.83, 7.17, 7.40 & 7.83 Ratios
	RS-26-180	U1399	6.83, 7.17, 7.40 & 7.83 Ratios
	RS-26-185	U1399	6.83, 7.17, 7.40 & 7.83 Ratios
	RS-30-180	C1381	6.83, 7.17, 7.40 & 7.83 Ratios
	RS-30-180	K1753	6.83, 7.17, 7.40 & 7.83 Ratios
	RS-30-180	U1399	6.83, 7.17, 7.40 & 7.83 Ratios
	RS-30-185	C1381	6.83, 7.17, 7.40 & 7.83 Ratios
	RS-30-185	K1753	6.83, 7.17, 7.40 & 7.83 Ratios
	RS-30-185	U1399	6.83, 7.17, 7.40 & 7.83 Ratios
	RT-48-180	3200-U-1399	6.83, 7.17 & 7.40 Ratios
	RT-48-180	C1381	6.83, 7.17, 7.40 & 7.83 Ratios
	RT-48-180	U1399	6.83, 7.17, 7.40 & 7.83 Ratios
	RT-48-185	C1381	6.83, 7.17, 7.40 & 7.83 Ratios
	RT-48-185	U1399	6.83, 7.17, 7.40 & 7.83 Ratios
	RT-52-180	3200-U-1399	6.83, 7.17 & 7.40 Ratios
	RT-52-180	C1381	6.83, 7.17, 7.40 & 7.83 Ratios
	RT-52-185	U1399	6.83, 7.17, 7.40 & 7.83 Ratios
	RT-58-180	3200-U-1399	6.83, 7.17 & 7.40 Ratios
	RT-58-180	C1381	6.83, 7.17, 7.40 & 7.83 Ratios
	RT-58-180	U1399	6.83, 7.17, 7.40 & 7.83 Ratios
<b>NDK4437</b>	RS-23-180	3200-W-1791, 3200-J-1804, 3200-A-1899	All except 6.83, 7.17 & 7.40
	RS-23-180	A1899	All Other Ratios
	RS-23-180	J1804	All Other Ratios
	RS-23-180	W1791	All Other Ratios
	RS-23-185	A1899	All Other Ratios
	RS-23-185	J1804	All Other Ratios
	RS-23-185	W1791	All Other Ratios
	RS-23-186	A1899	All Other Ratios
	RS-23-186	J1804	All Other Ratios
	RS-23-186	W1791	All Other Ratios
	RS-26-180	A1899	All Other Ratios
	RS-26-180	J1804	All Other Ratios
	RS-26-180	W1791	All Other Ratios
	RS-26-185	A1899	All Other Ratios
	RS-26-185	J1804	All Other Ratios
	RS-26-185	W1791	All Other Ratios
	RS-30-180	A1899	All Other Ratios
	RS-30-180	J1804	All Other Ratios
	RS-30-180	W1791	All Other Ratios
	RS-30-185	A1899	All Other Ratios
RS-30-185	J1804	All Other Ratios	
RS-30-185	W1791	All Other Ratios	
RT-48-180	3200-W-1791, 3200-J-1804, 3200-A-1899		
RT-48-180	A1899	All Other Ratios	
RT-48-180	J1804	All Other Ratios	
RT-48-180	W1791	All Other Ratios	
RT-48-185	A1899	All Other Ratios	
RT-48-185	J1804	All Other Ratios	
RT-48-185	W1791	All Other Ratios	
RT-52-180	3200-W-1791, 3200-J-1804, 3200-A-1899		
RT-52-180	A1899	All Other Ratios	
RT-52-180	J1804	All Other Ratios	
RT-52-180	W1791	All Other Ratios	
RT-52-185	A1899	All Other Ratios	
RT-52-185	J1804	All Other Ratios	

MERITOR KIT APPS BY KIT			
Kit	Axle Model	Carriers	Comments
<b>NDK4437</b>	RT-52-185	W1791	All Other Ratios
	RT-58-180	3200-W-1791, 3200-J-1804, 3200-A-1899 (All except 6.83, 7.17 & 7.40)	
	RT-58-180	A1899	All Other Ratios
	RT-58-180	J1804	All Other Ratios
	RT-58-180	W1791	All Other Ratios
<b>NDK4438</b>	RD-23-180	3200-W-1791, 3200-J-1804, 3200-A-1899	6.83, 7.17, 7.40 Ratios only
	RS-23-180	A1899	6.83, 7.17, 7.40 & 7.83 Ratios
	RS-23-180	J1804	6.83, 7.17, 7.40 & 7.83 Ratios
	RS-23-180	W1791	6.83, 7.17, 7.40 & 7.83 Ratios
	RS-23-185	A1899	6.83, 7.17, 7.40 & 7.83 Ratios
	RS-23-185	J1804	6.83, 7.17, 7.40 & 7.83 Ratios
	RS-23-185	W1791	6.83, 7.17, 7.40 & 7.83 Ratios
	RS-23-186	A1899	6.83, 7.17, 7.40 & 7.83 Ratios
	RS-23-186	J1804	6.83, 7.17, 7.40 & 7.83 Ratios
	RS-23-186	W1791	6.83, 7.17, 7.40 & 7.83 Ratios
	RS-26-180	A1899	6.83, 7.17, 7.40 & 7.83 Ratios
	RS-26-180	J1804	6.83, 7.17, 7.40 & 7.83 Ratios
	RS-26-180	W1791	6.83, 7.17, 7.40 & 7.83 Ratios
	RS-26-185	A1899	6.83, 7.17, 7.40 & 7.83 Ratios
	RS-26-185	J1804	6.83, 7.17, 7.40 & 7.83 Ratios
	RS-26-185	W1791	6.83, 7.17, 7.40 & 7.83 Ratios
	RS-30-180	A1899	6.83, 7.17, 7.40 & 7.83 Ratios
	RS-30-180	C1381	All Other Ratios
	RS-30-180	J1804	6.83, 7.17, 7.40 & 7.83 Ratios
	RS-30-180	W1791	6.83, 7.17, 7.40 & 7.83 Ratios
	RS-30-185	A1899	6.83, 7.17, 7.40 & 7.83 Ratios
	RS-30-185	J1804	6.83, 7.17, 7.40 & 7.83 Ratios
	RS-30-185	W1791	6.83, 7.17, 7.40 & 7.83 Ratios
	RT-48-180	3200-W-1791, 3200-J-1804, 3200-A-1899	6.83, 7.17 & 7.40 Ratios
	RT-48-180	A1899	6.83, 7.17, 7.40 & 7.83 Ratios
	RT-48-180	J1804	6.83, 7.17, 7.40 & 7.83 Ratios
	RT-48-180	W1791	6.83, 7.17, 7.40 & 7.83 Ratios
	RT-48-185	A1899	6.83, 7.17, 7.40 & 7.83 Ratios
	RT-48-185	J1804	6.83, 7.17, 7.40 & 7.83 Ratios
	RT-48-185	W1791	6.83, 7.17, 7.40 & 7.83 Ratios
	RT-52-180	3200-W-1791, 3200-J-1804, 3200-A-1899	6.83, 7.17 & 7.40 Ratios
	RT-52-180	A1899	6.83, 7.17, 7.40 & 7.83 Ratios
	RT-52-180	J1804	6.83, 7.17, 7.40 & 7.83 Ratios
	RT-52-180	W1791	6.83, 7.17, 7.40 & 7.83 Ratios
	RT-52-185	A1899	6.83, 7.17, 7.40 & 7.83 Ratios
	RT-52-185	J1804	6.83, 7.17, 7.40 & 7.83 Ratios
	RT-52-185	W1791	6.83, 7.17, 7.40 & 7.83 Ratios
	RT-58-180	3200-W-1791, 3200-J-1804, 3200-A-1899	6.83, 7.17 & 7.40 Ratios
	RT-58-180	A1899	6.83, 7.17, 7.40 & 7.83 Ratios
	RT-58-180	J1804	6.83, 7.17, 7.40 & 7.83 Ratios
	RT-58-180	W1791	6.83, 7.17, 7.40 & 7.83 Ratios

MERITOR KIT APPS BY KIT			
Kit	Axle Model	Carriers	Comments
<b>NDK4440</b>	RT-48-180	M1625	All Ratios
	RT-48-180	3200-M-1625	6.83, 7.17 & 7.40 Ratios
	RT-48-185	M1625	All Ratios
	RT-48-380	All	
	RT-48-380	3200-M-1625	
	RT-52-180	M1625	All Ratios
	RT-52-180	3200-M-1625	
	RT-52-185	M1625	All Ratios
	RT-52-380	All	
	RT-52-380	3200-M-1625	
	RT-58-180	M1625	All Ratios
	RT-58-180	3200-M-1625	
	RT-58-185	M1625	All Ratios
	RT-58-380	3200-M-1625	
	RT-70-380	M1625	All Ratios
RT-70-380	3200-M-1625		
<b>NDK4441</b>	RS-23-380	M1833	All Other Ratios
	RS-26-380	M1833	All Other Ratios
	RS-30-380	M1833	All Other Ratios
	RT-48-180	M1833	All Other Ratios
	RT-48-180	3200-M-1833	
	RT-48-185	M1833	All Other Ratios
	RT-48-380	M1833	All Other Ratios
	RT-48-380	3200-M-1833	
	RT-52-180	M1833	All Other Ratios
	RT-52-180	3200-M-1833	
	RT-52-185	M1833	All Other Ratios
	RT-52-380	M1833	All Other Ratios
	RT-52-380	3200-M-1833	
	RT-58-180	M1833	All Other Ratios
	RT-58-180	3200-M-1833	
RT-70-380	M1833	All Other Ratios	
RT-70-380	M1833	All Other Ratios	
RT-70-380	M1833	All Other Ratios	
RT-70-380	3200-M-1833		
<b>NDK4841</b>	MT-34		
	MT-40		
	MT-44		
<b>NDK4842</b>	MT-34		
	MT-40		
<b>NDK4843</b>	MS-17		
	MS-19		
	MS-21		
	MT-34		
	MT-40		
<b>NDK4844</b>	MT-44		
	MS-17		
	MS-19		
	MS-21		
	MT-34		
MT-40			
MT-44			

DANA KIT APPS BY AXLE		
Axle Model	Comments	Kit
D40-170		NDK442
D40-170P		NDK442
D40170DP		NDK436
D45-170DP		NDK436
D46-170		NDK442
D46-170H		NDK442
D46-170HP		NDK442
D46-170P		NDK442
D52-190DP		NDK437
D52-190P		NDK437
D60-190P		NDK437
F155-S		NDK191R
J175-S		NDK192RB
J190-S		NDK192RB
J210-S		NDK192RB
J220-S		NDK192RB
J230-S		NDK192RB
J230-SB		NDK192RB
J340-S		NDK192RB
J340-S		NDK220FA
J380-S		NDK192RB
J380-S		NDK200FA
J400-S		NDK192RB
J400-S		NDK200FA
M185-D		NDK214
M185-T		NDK214
M190-T		NDK214
M200-D		NDK214
M200-T		NDK214
M210-T		NDK214
M220-D		NDK214
M220-T		NDK214
M230-T		NDK214
N175		NDK223R
N190		NDK223R
N340-S		NDK223F
		NDK223R
N400-I		NDK223F
		NDK223R
R40-170	2.69-3.91 Ratios	NDK438
	4.10-7.17 Ratios	NDK439
R40-170D	4.10-7.17 Ratios	NDK444
	2.69-3.91 Ratios	NDK443
R46-170	2.69-3.91 Ratios	NDK438
	4.10-7.17 Ratios	NDK439
R46-170D	2.69-3.91 Ratios	NDK443
	4.10-7.17 Ratios	NDK444

DANA KIT APPS BY AXLE		
Axle Model	Comments	Kit
R52-190P	2.53-4.78 Ratios	NDK440
	5.25-7.83 Ratios	NDK441
R60-190P	2.53-4.78 Ratios	NDK440
	5.25-7.83 Ratios	NDK441
RA42	w/o Involute Splines and Serial #5141 & Above	NDK192R
RA43	w/o Involute Splines and Serial #5141 & Above	NDK192R
RA44	w/o Involute Splines and Serial #5141 & Above	NDK192R
RA47	w/o Involute Splines and Serial #5141 & Above	NDK192R
RA48	w/o Involute Splines and Serial #5141 & Above	NDK192R
RA341		NDK191F
RA351	Serial #18798 & Above	NDK192R
RA355	Diff Ser. #19798 & Up	NDK192R
RA386	Diff Ser. #18798 & Up	NDK192R
RA387	Diff Ser. #18798 & Up	NDK192R
RA472		NDK200F
RA474	Involute Splines	NDK201F
S14-110		NDK434
S14-111		NDK434
S16-130		NDK434
S16-132		NDK434
S21-170	2.69-3.91 Ratios	NDK438
	4.10-7.17 Ratios	NDK439
S21-170D	2.69-3.91 Ratios	NDK443
	4.10-7.17 Ratios	NDK444
S23-170	2.69-3.91 Ratios	NDK438
	4.10-7.17 Ratios	NDK439
S23-170D	2.69-3.91 Ratios	NDK443
	4.10-7.17 Ratios	NDK444
S26-190P	2.53-4.78 Ratios	NDK440
	5.25-7.83 Ratios	NDK441
S30-190P	2.53-4.78 Ratios	NDK440
	5.25-7.83 Ratios	NDK441
S135-S		NDK414
S150-S		NDK414
S230-S		NDK416
S230-SB		NDK416
S230-SL		NDK416
S260-SB		NDK416
W230-S		NDK201R
W440-S		NDK201FA
		NDK201R
W460-S		NDK201FA
		NDK201R

EATON KIT APPS BY AXLE		
Axle Model	Comments	Kit
30RS	w/ Ribbed Carrier	NDK23
	w/Conical Carrier	NDK23B
30RP		NDK23
30RT		NDK23
34D3	w/ Ball Bearing On Input Shaft	NDK64F
	w/ Taper Bearing On Input Shaft	NDK64FE
34DP	w/ Ball Bearing On Input Shaft	NDK64F
	w/ Taper Bearing On Input Shaft	NDK64FE
34DS	w/ Ribbed Barrier & Ball Bearing On Input Shaft	NDK64F
	w/Conical Carrier & Ball Bearing On Input Shaft	NDK64FC
	w/Conical Carrier & Taper Bearing On Input Shaft	NDK64FD
	w/ Ribbed Carrier & Taper Bearing On Input Shaft	NDK64FE
34DT	w/ Ball Bearing On Input Shaft	NDK64F
	w/ Taper Bearing On Input Shaft	NDK64FE
34R3		NDK1
34RP	w/ Ribbed Carrier	NDK1
	w/ Conical Carrier	NDK1A
34RS	w/ Conical Carrier	NDK1A
34RSB		NDK1A
34RT		NDK1
38D3	w/ Ball Bearing On Input Shaft	NDK64F
	w/ Taper Bearing On Input Shaft	NDK64FE
38DP	w/ Ball Bearing On Input Shaft	NDK64F
	w/ Taper Bearing On Input Shaft	NDK64FE
38DS	w/ Ribbed Barrier & Ball Bearing On Input Shaft	NDK64F
	w/Conical Carrier & Ball Bearing On Input Shaft	NDK64FC
	w/Conical Carrier & Taper Bearing On Input Shaft	NDK64FD
	w/ Ribbed Barrier & Taper Bearing On Input Shaft	NDK64FE
38DT	w/ Ball Bearing On Input Shaft	NDK64F
	w/ Taper Bearing On Input Shaft	NDK64FE
38R3		NDK1
38RP	w/ Ribbed Carrier	NDK1
	w/ Conical Carrier	NDK1A
38RS		NDK1A
38RSB		NDK1A
38RT		NDK1
42D3	w/ Ball Bearing On Input Shaft	NDK64F
	w/ Taper Bearing On Input Shaft	NDK64FE
42DP	w/ Ball Bearing On Input Shaft	NDK64F
	w/ Taper Bearing On Input Shaft	NDK64FE
42DT	w/ Ball Bearing On Input Shaft	NDK64F
	w/ Taper Bearing On Input Shaft	NDK64FE
42R3		NDK1
42RP		NDK1
42RS		NDK18D
42RT		NDK1
44DS		NDK208A
44DSM		NDK208A
44DT		NDK72A
44RPB		NDK72A
44RS	w/ Casting #C98493 After 2/1/79	NDK219R
	w/ Casting #C67854 Before 2/1/79	NDK413
44RSB	w/ Large Spherical Diff	NDK18E
44RSM		NDK413

EATON KIT APPS BY AXLE		
Axle Model	Comments	Kit
44RT	w/o 103537 Case	NDK72A
	w/ 103537 Case	NDK72B
44RTB		NDK72A
50RP		NDK1
50RT		NDK1
190C4		NDK419
190P4		NDK419
190T4		NDK419
220C4		NDK419
220P4		NDK419
220T4		NDK419
230C4		NDK420
230P4		NDK421
230S4		NDK418
230T4		NDK421
260C4		NDK420
300C4		NDK420
260P4		NDK421
260S4		NDK418
260T4		NDK421
300P4		NDK420
300S4		NDK418
300T4		NDK421
350		NDK24
350C4		NDK420
350P4		NDK420
350S4		NDK418
350T4		NDK420
502		NDK72
503		NDK72
1350	Exc. Dodge 1957-1958	NDK24
1618		NDK23
1619		NDK23
1880		NDK1
1881		NDK1
3527	w/ 103537 Case	NDK219R
	w/ 27950 Case	NDK413
3800		NDK24
3802		NDK24
3803		NDK23
6802		NDK23
7500		NDK202
7800		NDK1
7801		NDK1
7810		NDK1
8800		NDK1
8802		NDK1
8803		NDK1
9000		NDK202
9502		NDK72
9503		NDK72
9512		NDK72
10000		NDK202
12000		NDK202
13602		NDK24
13800		NDK24
13802		NDK24
13803		NDK24
15040-S		NDK24
15040-T		NDK24
15101		NDK24
15200		NDK24

EATON KIT APPS BY AXLE		
Axle Model	Comments	Kit
15201		NDK24
15300		NDK24
15301		NDK24
16120		NDK23D
16123		NDK23D
16220	w/ 15-1/2" Ring Gear	NDK23D
16244		NDK23D
16247		NDK23D
16320		NDK23
16321		NDK23
16344		NDK23D
16500		NDK23
16501		NDK23
16620	w/ 15" Ring Gear	NDK23
16800		NDK23
16802		NDK23
16803		NDK23
170605		NDK404R
17100		NDK1A
17101		NDK1A
17120		NDK1A
17121		NDK1A
17123		NDK1A
17200		NDK1
17201		NDK1
17202		NDK1
17220		NDK1
17221		NDK1
17300		NDK1
17301		NDK1
17302		NDK1
17320		NDK1
17321		NDK1
17322		NDK1
17401		NDK1
17421		NDK1
17500		NDK1
17501		NDK1
17800		NDK1
17810		NDK1
18100		NDK1A
18101		NDK1A
18103		NDK1A
18120		NDK1A
18121		NDK1A
18123		NDK1A
18200		NDK1
18201		NDK1
18202		NDK1
18207		NDK1
18220		NDK1
18221		NDK1
18227		NDK1
18300		NDK1
18301		NDK1
18302		NDK1
18320		NDK1
18321		NDK1
18322		NDK1
18500		NDK1
18501		NDK1
18502		NDK1

EATON KIT APPS BY AXLE		
Axle Model	Comments	Kit
18503		NDK1
18800		NDK1
18802		NDK1
18803		NDK1
18812		NDK1
18813		NDK1
19050-P		NDK23D
19050-T		NDK23D
19055-D		NDK406
19055-P		NDK403
19055-S		NDK406
19055-T		NDK403
19060S		NDK404R
19060-D		NDK405R
19060-T		NDK1
19100		NDK415
19120		NDK18D
19121	Exc. Dodge	NDK18D
19123		NDK18D
19200		NDK72
19201		NDK72
19202		NDK72
19220	w/o 103537 Case w/ 103537 Case	NDK72A NDK72B
19221	w/o 103537 Case w/ 103537 Case	NDK72A NDK72B
19223		NDK72A
19227	After 2/1/79 Before 2/1/79	NDK219R NDK413
19237	After 2/1/79	NDK219R
19300		NDK72
19301		NDK72
19320		NDK72A
19321	w/o 103537 Case w/ 103537 Case	NDK72A NDK72B
19323		NDK72A
19327		NDK413
19420		NDK413
19426		NDK413
19500		NDK72
19501		NDK72
19502		NDK72
19503		NDK72
19512		NDK72
19513		NDK72
19515		NDK72
20000		NDK72
20100		NDK415
20120		NDK18D
20121		NDK18D
20123		NDK18D
20200		NDK72
20201		NDK72
20220	w/o 103537 Case w/ 103537 Case	NDK72A NDK72B
20221	w/ 103537 Case w/o 103537 Case	NDK72B NDK72B
20223		NDK72A
20300		NDK72
20301		NDK72
20320	w/o 103537 Case w/ 103537 Case	NDK72A NDK72B

EATON KIT APPS BY AXLE		
Axle Model	Comments	Kit
20321	w/o 103537 Case	NDK72A
	w/ 103537 Case	NDK72B
20323		NDK72A
20500		NDK72
20501		NDK72
20502		NDK72
20503		NDK72
21060S		NDK404R
21060-D		NDK405R
21060-T		NDK1
21065-D		NDK406
21065-P		NDK403
21065-S		NDK406
21065-T		NDK403
21065-Y		NDK403
21080-D		NDK410
21080-S		NDK410
21121		NDK1A
21221		NDK1
21321		NDK1
21421		NDK1
22060-D		NDK405R
22060S		NDK404R
22060-SH		NDK429
22065-D		NDK406
22065-P		NDK403
22065-S		NDK406
22065-T		NDK403
22120		NDK412
22121		NDK412
22220		NDK403
22221		NDK403
22320		NDK403
22321		NDK403
22420		NDK403
22421		NDK403
22427		NDK403
23080P	After 4/6/88	NDK219R
	Before 4/6/88	NDK72B
23080T	After 4/6/88	NDK219R
	Before 4/6/88	NDK72B
23080-D		NDK410
23080-S		NDK410
23085C		NDK219R
23085-D		NDK410
23085-S		NDK410
23105-C		NDK401
23105-S		NDK402
23120	Large Spherical Differential	NDK18E
23121	GMC Trucks	NDK415
	Non-GMC Trucks	NDK18E
23202		NDK72
23220	w/ 27950 Case	NDK72A
	w/ 103537 Case	NDK72B
23221	w/ 27950 Case	NDK72A
	w/ 103537 Case	NDK72B
23227	After 2/1/79	NDK219R
	Before 2/1/79	NDK413
23302		NDK72

EATON KIT APPS BY AXLE		
Axle Model	Comments	Kit
23320	w/ 27950 Case	NDK72A
	w/ 103537 Case	NDK72B
23321	w/ 27950 Case	NDK72A
	w/ 103537 Case	NDK72B
23327	Before 2/1/79	NDK219R
	w/ 103537 Case	NDK413
23420	Before 2/1/79	NDK219R
	After 2/1/79	NDK413
23421	After 2/1/79	NDK219R
23427		NDK219R
23430	w/ CTD	NDK219R
23433		NDK219R
26080-D		NDK410
26080-S		NDK410
26085P	After 4/6/88	NDK219R
	Before 4/6/88	NDK72B
26085T	After 4/6/88	NDK219R
	Before 4/6/88	NDK72B
26105-C		NDK401
26105-S		NDK402
26120	Small Spherical Differential	NDK18D
	Large Spherical Differential	NDK18E
26121	Small Spherical Differential	NDK18D
	Large Spherical Differential	NDK18E
26123	Small Spherical Differential	NDK18D
	Large Spherical Differential	NDK18E
26220	w/ 27950 Case	NDK72A
	w/ 103537 Case	NDK72B
26221	w/ 27950 Case	NDK72A
	w/ 103537 Case	NDK72B
26223	w/ 27950 Case	NDK72A
26320	w/ 103537 Case	NDK72B
	w/ 27950 Case	NDK72A
26321	w/ 103537 Case	NDK72B
	w/ 27950 Case	NDK72A
26323	w/ 27950 Case	NDK72B
	w/ 103537 Case	NDK72B
26420		NDK413
26421		NDK219R
26426		NDK413
30055P		NDK219R
30105-C		NDK401
30105-S		NDK402
33321	w/ 27950 Case	NDK72A
	w/ 103537 Case	NDK72B
35055P		NDK219R
35227	w/ 103537 Case	NDK219R
	w/ 27950 Case	NDK413
DA344		NDK404F
DA402P	After 1/1/95	NDK196
	4/6/89 through 12/31/94	NDK222F
DA404P	Before 6/16/08	NDK404F
	After 6/16/08	NDK404FA
DA405P	Before 6/16/08	NDK404F
	After 6/16/08	NDK404FA
DA454P		NDK404F
DC341P		NDK207
DC381P		NDK207
DC386P		NDK424
DC401-P		NDK207
DC402P		NDK207
DC406-P		NDK424
DC451-P		NDK207



EATON KIT APPS BY AXLE		
Axle Model	Comments	Kit
DC460-P		NDK211F
DC461-P	Prior 2/2000	NDK211F
	After 2/2000	NDK432
DC462-P	Prior 2/2000	NDK211F
	After 2/2000	NDK432
DC463-P	Prior 2/2000	NDK211F
	After 2/2000	NDK432
DC480-P		NDK211F
DC521-P	Prior 2/2000	NDK211F
	After 2/2000	NDK432
DC3416-P		NDK424
DC4026-P		NDK424
DC4616-P		NDK426
DC5216-P		NDK426
DD404P	Before 6/16/08	NDK405F
	After 6/16/08	NDK405FA
DD405P	Before 6/16/08	NDK405F
	After 6/16/08	NDK405FA
DD454P		NDK405F
DD461-P	Prior 2/2000	NDK211F
	After 2/2000	NDK432
DD462-P	Prior 2/2000	NDK211F
	After 2/2000	NDK432
DD463-P	Prior 2/2000	NDK211F
	After 2/2000	NDK432
DD521-P		NDK432
DD581-P	Prior 2/2000	NDK211F
	After 2/2000	NDK432
DD601P	Prior 2/2000	NDK211F
	After 2/2000	NDK432
DD651P	Prior 2/2000	NDK211F
	After 2/2000	NDK432
DDH40P	Before 6/16/08	NDK428
	After 6/16/08	NDK428A
DDH44P		NDK427
DDP40P	Before 6/16/08	NDK428
	After 6/16/08	NDK428A
DDP41P	Before 6/16/08	NDK428
	After 6/16/08	NDK428A
DDT40-P	Before 6/16/08	NDK405F
	After 6/16/08	NDK405FA
DDT41P	Before 6/16/08	NDK405F
	After 6/16/08	NDK405FA
DP341P		NDK207
DP381P		NDK207
DP386P		NDK424
DP401P		NDK207
DP402P		NDK207
DP406-P		NDK424
DP440-P	22 Spline & Case #103530	NDK209
	36 Spline & Case #110500	NDK210
DP446-P		NDK426
DP451-P		NDK207
DP460-P	22 Spline & Case #103530	NDK209
	36 Spline & Case #110500	NDK210
DP461-P	Prior 2/2000	NDK211F
	After 2/2000	NDK432
DP462-P	Prior 2/2000	NDK211F
	After 2/2000	NDK432
DP463-P	Prior 2/2000	NDK211F
	After 2/2000	NDK432
DP466-P		NDK426

EATON KIT APPS BY AXLE		
Axle Model	Comments	Kit
DP480-P	22 Spline & Case #103530	NDK209
	36 Spline & Case #110500	NDK210
DP485-P		NDK211F
DP521-P	Prior 2/2000	NDK211F
	After 2/2000	NDK432
DP550	36 Spline & Case #110500	NDK211F
	22 Spline & Case #103530	NDK211FA
DP580-P	36 Spline & Case #110500	NDK211F
	22 Spline & Case #103530	NDK211FA
DP601-P	Prior 2/2000	NDK211F
	After 2/2000	NDK432
DP650-P	36 Spline & Case #110500	NDK211F
	22 Spline & Case #103530	NDK211FA
DP651-P	Prior 2/2000	NDK211F
	After 2/2000	NDK432
DP3416-P		NDK424
DP4026-P		NDK424
DP4616-P		NDK426
DP5216-P		NDK426
DP6016-P		NDK426
DP6516-P		NDK426
DS341P	Before 4/6/89	NDK196
	After 1/1/95	NDK196
	4/6/89 through 12/31/94	NDK222F
DS344	Before 6/16/08	NDK404F
	After 6/16/08	NDK404FA
DS381P		NDK196
DS385		NDK1
DS386P		NDK422
DS401P		NDK196
DS402P	Before 4/6/89	NDK196
	After 1/1/95	NDK196
	4/6/89 through 12/31/94	NDK222F
DS403P	Before 4/6/89	NDK196
	After 1/1/95	NDK196
DS404P	4/6/89 through 12/31/94	NDK222F
	Before 6/16/08	NDK404F
DS404P	After 6/16/08	NDK404FA
	Before 6/16/08	NDK404F
DS405P	Before 6/16/08	NDK404F
	After 6/16/08	NDK404FA
DS406-P		NDK422
DS440-P	36 Spline & Case #110500	NDK208
	22 Spline & Case #103530	NDK208A
DS446-P	w/ Traction Control	NDK426
DS451P	Before 4/6/89	NDK196
	After 1/1/95	NDK196
	4/6/89 through 12/31/94	NDK222F
DS454P		NDK404F
DS460-P	36 Spline & Case #110500	NDK208
	22 Spline & Case #103530	NDK208A
DS461-P	Prior 2/2000	NDK208
	After 2/2000	NDK433
DS462-P	Prior 2/2000	NDK208
	After 2/2000	NDK433
DS463-P	Prior 2/2000	NDK208
	After 2/2000	NDK433
DS480-P	36 Spline & Case #110500	NDK208
	22 Spline & Case #103530	NDK208A
DS521-P	Prior 2/2000	NDK208
	After 2/2000	NDK433
DS581-P	Prior 2/2000	NDK208
	After 2/2000	NDK433

EATON KIT APPS BY AXLE		
Axle Model	Comments	Kit
DS601P	Prior 2/2000	NDK208
	After 2/2000	NDK433
DS651-P	Prior 2/2000	NDK208
	After 2/2000	NDK433
DS3416-P		NDK422
DS4026-P		NDK422
DSH40P	Before 6/16/08	NDK427
	After 6/16/08	NDK427A
DSH44P		NDK428
DSP40P	Before 6/16/08	NDK427
	After 6/16/08	NDK427A
DSP41P	Before 6/16/08	NDK427
	After 6/16/08	NDK427A
DSS40P		NDK431
DST40P	Before 6/16/08	NDK404F
	After 6/16/08	NDK404FA
DT341P		NDK207
DT381P		NDK207
DT386P		NDK424
DT401P		NDK207
DT402P		NDK207
DT406-P		NDK424
DT440-P	22 Spline & Case #103530	NDK209
	36 Spline & Case #110500	NDK210
DT446-P		NDK426
DT451-P		NDK207
DT460-P	22 Spline & Case #103530	NDK209
	36 Spline & Case #110500	NDK210
DT461-P	Prior 2/2000	NDK211F
	After 2/2000	NDK432
DT462-P	Prior 2/2000	NDK211F
	After 2/2000	NDK432
DT463-P	Prior 2/2000	NDK211F
	After 2/2000	NDK432
DT466-P		NDK426
DT480-P		NDK211F
	22 Spline & Case #103530	NDK209
	36 Spline & Case #110500	NDK210
DT521-P	Prior 2/2000	NDK211F
	After 2/2000	NDK432
DTS80-P	36 Spline & Case #110500	NDK211F
	22 Spline & Case #103530	NDK211FA
DT601-P	Prior 2/2000	NDK211F
	After 2/2000	NDK432
DT650-P	36 Spline & Case #110500	NDK211F
	22 Spline & Case #103530	NDK211FA
DT651-P	Prior 2/2000	NDK211F
	After 2/2000	NDK432
DT3416-P		NDK424
DT4026-P		NDK424
DT4616-P		NDK426
DT5216-P		NDK426
DT6016-P		NDK426
DT6516-P		NDK426
RA344		NDK404R
RA402	4/6/89 through 12/31/94	NDK222R
	After 1/1/95	NDK412
RA404		NDK404R
RA405		NDK404R
RA454		NDK404R
RC341		NDK1
RC381		NDK1

EATON KIT APPS BY AXLE		
Axle Model	Comments	Kit
RC386		NDK1
RC401		NDK1
RC402		NDK1
RC406		NDK1
RC451		NDK1
RC460		NDK219R
RC461		NDK219R
RC462		NDK219R
RC463		NDK219R
RC480		NDK219R
RC521		NDK219R
RC601		NDK219R
RC651		NDK219R
RC3416		NDK1
RC4026		NDK1
RC4616		NDK72B
RC5216		NDK72B
RD404		NDK405R
RD405		NDK405R
RD454		NDK405R
RD461		NDK219R
RD462		NDK219R
RD463		NDK219R
RD521		NDK219R
RD581		NDK219R
RDH40		NDK430
RDH44		NDK429
RDP40		NDK430
RDP41		NDK430
RD540		NDK219R
RDT40		NDK445
RDT41		NDK445
RP340		NDK1
RP341		NDK1
RP380P	1-Speed Carrier After 4/30/78	NDK1
RP381P		NDK1
RP386-P		NDK1
RP400P		NDK1
RP401P		NDK1
RP402P		NDK1
RP406-P		NDK1
RP440		NDK72B
RP446P		NDK72B
RP451-P		NDK1
RP460		NDK72B
RP461		NDK219R
RP462		NDK219R
RP463		NDK219R
RP466P		NDK72B
RP480		NDK72B
RP485		NDK72B
RP521		NDK219R
RP550		NDK72B
RP580		NDK219R
RP601		NDK219R
RP650		NDK219R
RP651		NDK219R
RP3416-P		NDK1
RP4026-P		NDK1
RP4616P		NDK219R
RP5216P		NDK219R
RP6016P		NDK219R

EATON KIT APPS BY AXLE		
Axle Model	Comments	Kit
RP6516P		NDK219R
RS340	2-Speed Carrier Before 4/30/78	NDK1
	1-Speed Carrier After 4/30/78	NDK1A
RS341	Before 4/6/89	NDK1A
	4/6/89 through 12/31/94	NDK222R
	After 1/1/95	NDK412
RS344		NDK404R
RS380		NDK1
		NDK1A
RS381		NDK1A
RS386		NDK1A
RS400	2-Speed Carrier Before 4/30/78	NDK1
	1-Speed Carrier After 4/30/78	NDK1A
RS401		NDK1A
RS402	Before 4/6/89	NDK1A
	4/6/89 through 12/31/94	NDK222R
	After 1/1/95	NDK412
RS403	Before 4/6/89	NDK1A
	4/6/89 through 12/31/94	NDK222R
	After 1/1/95	NDK412
RS404		NDK404R
RS405		NDK404R
RS406		NDK1A
RS440		NDK18E
RS446	w/o Traction Control	NDK18E
	w/ Traction Control	NDK72B
RS451	Before 4/6/89	NDK1A
	4/6/89 through 12/31/94	NDK222R
	After 1/1/95	NDK412
RS454		NDK404R
RS460		NDK18E
RS461		NDK449
RS462		NDK449
RS463		NDK449
RS466	w/o Traction Control	NDK18E
	w/ Traction Control	NDK72B
RS480		NDK18E
RS521		NDK449
RS580	w/ Traction Control	NDK219R
RS581		NDK449
RS601		NDK449
RS650	w/ Traction Control	NDK219R
RS651		NDK449
RS3416		NDK1A
RS4026		NDK1A
RS4616		NDK449
RS5216		NDK449
RSH40		NDK429
RSH44		NDK429

EATON KIT APPS BY AXLE		
Axle Model	Comments	Kit
RSP40		NDK429
RSP41		NDK429
RSS40		NDK449
RST40	Before 4/1/05 & 2.64-5.57 Ratios	NDK445
RST41	Before 4/1/05 & 2.64-5.57 Ratios	NDK445
RT340		NDK1
RT341		NDK1
RT380P		NDK1
RT381P		NDK1
RT386-P		NDK1
RT400P		NDK1
RT401P		NDK1
RT402P		NDK1
RT406-P		NDK1
RT440		NDK72B
RT446P		NDK72B
RT451-P		NDK1
RT460		NDK72B
RT461		NDK219R
RT462		NDK219R
RT463		NDK219R
RT466P		NDK72B
RT480		NDK72B
RT485		NDK72B
RT521		NDK219R
RT550		NDK72B
RT580		NDK219R
RT601		NDK219R
RT650		NDK219R
RT651		NDK219R
RT3416-P		NDK1
RT4026-P		NDK1
RT4616P		NDK219R
RT5216P		NDK219R
RT6016P		NDK219R
RT6516P		NDK219R
SP461		NDK220F
SP462		NDK220F
SP463		NDK220F
SP521		NDK220F
SP601		NDK220F
SP651		NDK220F
TP461		NDK220F
TP462		NDK220F
TP463		NDK220F
TP521		NDK220F
TP601		NDK220F
TP651		NDK220F

**FREIGHTLINER KIT APPS BY AXLE**

Axle Model	Comments	Kit
ARS-13-2		NDK651
ARS-15-2		NDK651
ARS-17.5-2		NDK651
ARS-17.5-4		NDK650R
ARS-19-2		NDK651
ARS-19-4		NDK650R
ARS-20-4		NDK650R
ARS-21-2		NDK651
ARS-23-4		NDK650R
ART-34-4		NDK650F
ART-34-4		NDK650R
ART-40-4		NDK650F
ART-40-4		NDK650R
ART-44-4		NDK650F
ART-44-4		NDK650R

**MACK KIT APPS BY AXLE**

Axle Model	Comments	Kit
AWDR48		NDK117
C150		NDK507
C151		NDK507
		NDK508
CRD78		NDK117
CRD93	w/ 11KH5326, 5327, 5330	NDK205
	w/ 11KH5326, 5327, 5330	NDK205A
CRD93A		NDK503
CRD94		NDK117
CRD96		NDK212R
CRD113	w/ 11KH5341, 5342	NDK205
	w/ 11KH5341, 5342	NDK205A
CRD116	w/ 11KHA4165, 4165A	NDK117
	Non-Current	NDK117A
CRD117	w/ 11KHA4159API-AP14	NDK117
	w/ 11KHA45159CP12	NDK117
	Non-Current	NDK117A
CRD118		NDK117
CRD150		NDK507
CRD151		NDK507
		NDK508
CRD201		NDK501
CRD202		NDK500
CRD203		NDK501
CRD781		NDK117
CRD1161	w/ 11KHA4159, 4159A, 4166, 4166A	NDK117
	Non-Current	NDK117A
CRD1171	w/ 11KHA4159C, 4167B	NDK117
	w/ 11KHA4167, 4167A	NDK117
	Non-Current	NDK117A
CRD1511		NDK507
		NDK508
CRDLP92	w/ 11KH5312, 5313	NDK206
	w/ 11KH5312, 5313	NDK206A
	w/ 11KH5313	NDK206
	w/ 11KH5313	NDK206A
	w/ 11KH5316, 5317, 5318, 5319	NDK206
	w/ 11KH5316, 5317, 5318, 5319	NDK206A
CRDLP93		NDK205
		NDK205A
CRDP95		NDK212F
CRDP200		NDK500
		NDK506
CRDPC112	w/ 11KH5333, 5334, 5336	NDK206
	w/ 11KH5333, 5334, 5336	NDK206A
CRDPC150		NDK507
CRDPC1501		NDK507
RAD23		NDK117
RAD303		NDK501
RAD305		NDK117
RAD500		NDK117
RAD501		NDK117

MACK KIT APPS BY AXLE		
Axle Model	Comments	Kit
RAD507		NDK117
RAD508		NDK117
RAD509		NDK117
RAD512		NDK117
RAD529		NDK117
RAD529CW		NDK117
RAD530		NDK117
RAD530C		NDK117
RAD606		NDK117
RAD606C		NDK117
RAD705		NDK117
RAD5291		NDK117
RADF1000		NDK117
RADL529		NDK117
RADL5291		NDK117
RADP1001		NDK117
RAS500		NDK117
SS65		NDK212F NDK212R
SW30		NDK205 NDK205A
SW31		NDK205 NDK205A
SW65		NDK212F NDK212R
SW80		NDK212F NDK212R
SWD32		NDK206 NDK206A
SWD69		NDK212F NDK212R
SWD691		NDK212F NDK212R
SWP801		NDK212F NDK212R
SWS59		NDK212F NDK212R
SWS92		NDK212F NDK212R
SWS93		NDK212F NDK212R
SWS592		NDK212F NDK212R
SWW59		NDK212F NDK212R
SWW69		NDK212F NDK212R
SWW69W		NDK212F NDK212R
SWW592		NDK212F NDK212R
SWWP95		NDK212F NDK212R

MERITOR KIT APPS BY AXLE			
Axle Model	Carriers	Comments	Kit
210, 220, 224, 230 & 240 Series Single Axles	RS-15-210	All	NDK216
59722			NDK2108
59723			NDK2108
59733			NDK2108
C100			NDK2111
C102			NDK2111
C103			NDK2111
ELHD		w/Ratios Above 4.63:1 & 1-3/16" I.D. Pinion Rear Bearing	NDK9F
		w/Ratios Above 4.63:1 & 1-3/16" I.D. Pinion Rear Bearing	NDK9R
		w/Ratios Above 4.63:1 & 1-3/8" I.D. Pinion Rear Bearing	NDK9RB
		w/ Ratios of 4:63:1 & Below & 1-3/8" I.D. Pinions Rear Bearing	NDK9RC
		w/Ratios Above & Below 4.63:1 & 1-3/8" I.D. Pinion Rear Bearing	NDK900F
EQHD		w/Ratios Above & Below 4.63:1 & 1-3/8" I.D. Pinion Rear Bearing	NDK900FA
		w/Ratios Above 4.63:1 & 1-3/16" I.D. Pinion Rear Bearing	NDK9F
		w/Ratios Above 4.63:1 & 1-3/16" I.D. Pinion Rear Bearing	NDK9R
		w/Ratios Above 4.63:1 & 1-3/8" I.D. Pinion Rear Bearing	NDK9RB
		w/ Ratios of 4:63:1 & Below & 1-3/8" I.D. Pinions Rear Bearing	NDK9RC
ERLHD		w/Ratios Above & Below 4.63:1 & 1-3/8" I.D. Pinion Rear Bearing	NDK900F
		w/Ratios Above & Below 4.63:1 & 1-3/8" I.D. Pinion Rear Bearing	NDK900FA
		w/Ratios Above 4.63:1 & 1-3/16" I.D. Pinion Rear Bearing	NDK9F
		w/Ratios Above 4.63:1 & 1-3/16" I.D. Pinion Rear Bearing	NDK9R
		w/Ratios Above 4.63:1 & 1-3/8" I.D. Pinion Rear Bearing	NDK9RB
ERQHD		w/ Ratios of 4:63:1 & Below & 1-3/8" I.D. Pinions Rear Bearing	NDK9RC
		w/Ratios Above & Below 4.63:1 & 1-3/8" I.D. Pinion Rear Bearing	NDK900F
		w/Ratios Above & Below 4.63:1 & 1-3/8" I.D. Pinion Rear Bearing	NDK900FA
		w/Ratios Above 4.63:1 & 1-3/16" I.D. Pinion Rear Bearing	NDK9F
		w/Ratios Above 4.63:1 & 1-3/16" I.D. Pinion Rear Bearing	NDK9R
ESQHD		w/Ratios Above 4.63:1 & 1-3/8" I.D. Pinion Rear Bearing	NDK9RB
		w/ Ratios of 4:63:1 & Below & 1-3/8" I.D. Pinions Rear Bearing	NDK9RC
		w/Ratios Above & Below 4.63:1 & 1-3/8" I.D. Pinion Rear Bearing	NDK900F
		w/Ratios Above & Below 4.63:1 & 1-3/8" I.D. Pinion Rear Bearing	NDK900FA
		w/Ratios Above 4.63:1 & 1-3/16" I.D. Pinion Rear Bearing	NDK9F

MERITOR KIT APPS BY AXLE			
Axle Model	Carriers	Comments	Kit
ESQHD		w/Ratios Above & Below 4.63:1 & 1-3/8" I.D. Pinion Rear Bearing	NDK900F
		w/Ratios Above & Below 4.63:1 & 1-3/8" I.D. Pinion Rear Bearing	NDK900FA
F105			NDK4315
	3200-R-1110		NDK4315
F106			NDK4315
	3200-R-1110		NDK4315
F140			NDK4310
	3200-R-1110		NDK4310
F145			NDK4310
	3200-R-1110		NDK4310
F146			NDK4310
	3200-R-1110		NDK4310
F147			NDK4310
	3200-R-1110		NDK4310
F149			NDK4310
FDS1807	#3200H606		NDK172R
FDS1808	#3200G969		NDK172R
FDS2100	#3200G969		NDK172R
FDS2101	#3200H606		NDK172R
H120		1-3/16" Pinion Bearing and Ratios above 4.63	NDK9R
		Early w/ 1-3/16" I.D. Pinion Rear Bearing & Ratios Above 4.63:1	NDK9R
		Ratios above 4.63	NDK9RB
		Late w/ 1-3/8" I.D. Pinion Rear Bearing & Ratios Above 4.63:1	NDK9RB
		3.55-4.63 Ratios	NDK9RC
		Late w/ 1-3/8" I.D. Pinion Rear Bearing & Ratios Above 4.63:1 & Below	NDK9RC
H170			NDK4325
	3200-N-924		NDK4325
H172			NDK4330
	3200-Y-1091		NDK4330
H173			NDK4330
L100		1-3/16" Pinion Bearing and Ratios above 4.63	NDK9R
		Early w/ 1-3/16" I.D. Pinion Rear Bearing & Ratios Above 4.63:1	NDK9R
		Ratios above 4.63	NDK9RB
		Late w/ 1-3/8" I.D. Pinion Rear Bearing & Ratios Above 4.63:1	NDK9RB
		3.55-4.63 Ratios	NDK9RC
		Late w/ 1-3/8" I.D. Pinion Rear Bearing & Ratios Above 4.63:1 & Below	NDK9RC
L100A		Early w/ 1-3/16" I.D. Pinion Rear Bearing & Ratios Above 4.63:1	NDK9R
		Ratios above 4.63	NDK9RB
		1-3/16" Pinion Bearing and Ratios above 4.63	NDK9RB
		Late w/ 1-3/8" I.D. Pinion Rear Bearing & Ratios Above 4.63:1	NDK9RB
		3.55-4.63 Ratios	NDK9RC
		Late w/ 1-3/8" I.D. Pinion Rear Bearing & Ratios Above 4.63:1 & Below	NDK9RC
L101		1-3/16" Pinion Bearing and Ratios above 4.63	NDK9R
		Early w/ 1-3/16" I.D. Pinion Rear Bearing & Ratios Above 4.63:1	NDK9R
		Ratios above 4.63	NDK9RB

MERITOR KIT APPS BY AXLE			
Axle Model	Carriers	Comments	Kit
L101		Late w/ 1-3/8" I.D. Pinion Rear Bearing & Ratios Above 4.63:1	NDK9RB
		3.55-4.63 Ratios	NDK9RC
L110		Late w/ 1-3/8" I.D. Pinion Rear Bearing & Ratios Above 4.63:1 & Below	NDK9RC
		1-3/16" Pinion Bearing and Ratios above 4.63	NDK9R
		Early w/ 1-3/16" I.D. Pinion Rear Bearing & Ratios Above 4.63:1	NDK9R
		Ratios above 4.63	NDK9RB
		Late w/ 1-3/8" I.D. Pinion Rear Bearing & Ratios Above 4.63:1	NDK9RB
		3.55-4.63 Ratios	NDK9RC
L110A		Late w/ 1-3/8" I.D. Pinion Rear Bearing & Ratios Above 4.63:1 & Below	NDK9RC
		1-3/16" Pinion Bearing and Ratios above 4.63	NDK9R
		Early w/ 1-3/16" I.D. Pinion Rear Bearing & Ratios Above 4.63:1	NDK9R
		Ratios above 4.63	NDK9RB
		Late w/ 1-3/8" I.D. Pinion Rear Bearing & Ratios Above 4.63:1	NDK9RB
		3.55-4.63 Ratios	NDK9RC
L172			NDK4330
L173			NDK4330
LT100			NDK9RC
MS-17			NDK4843
MS-19			NDK4844
			NDK4843
MS-21			NDK4844
			NDK4843
MT-34			NDK4841
			NDK4842
			NDK4843
			NDK4844
MT-40			NDK4841
			NDK4842
			NDK4843
			NDK4844
MT-40-143	B1978	Prior to 11/93 w/ Original 39 Spline Input	NDK217F
	B1978	Prior to 11/93 w/ New 46 Spline Input	NDK4395
	B1978	After 11/93	NDK4396
	C1979	Prior to 11/93 w/ Original 39 Spline Input	NDK217F
	C1979	Prior to 11/93 w/ New 46 Spline Input	NDK4395
	C1979	After 11/93	NDK4396
	D1902	Prior to 11/93	NDK4405
	D1902	After 11/93	NDK4406
	E1903	Prior to 11/93	NDK4405
	E1903	After 11/93	NDK4406
	E1981	Prior to 11/93	NDK4405
	E1981	After 11/93	NDK4406
	F1852	Prior to 11/93 w/ Original 39 Spline Input	NDK217F
	F1852	Prior to 11/93 w/ New 46 Spline Input	NDK4395

MERITOR KIT APPS BY AXLE			
Axle Model	Carriers	Comments	Kit
<b>MT-40-143</b>	F1852	After 11/93	NDK4396
	G1645	Prior to 11/93 w/ Original 39 Spline Input	NDK217F
	G1645	Prior to 11/93 w/ New 46 Spline Input	NDK4395
	G1645	After 11/93	NDK4396
	G1853	Prior to 11/93 w/ Original 39 Spline Input	NDK217F
	G1853	Prior to 11/93 w/ New 46 Spline Input	NDK4395
	G1853	After 11/93	NDK4396
	H1984	Prior to 11/93 w/ Original 39 Spline Input	NDK217F
	H1984	Prior to 11/93 w/ New 46 Spline Input	NDK4395
	H1984	After 11/93	NDK4396
	K1984	Prior to 11/93	NDK4405
	K1987	After 11/93	NDK4406
	L1624	Prior to 11/93	NDK4405
	L1624	After 11/93	NDK4406
	M1677	Prior to 11/93	NDK4405
	M1677	After 11/93	NDK4406
	N1860	Prior to 11/93 w/ Original 39 Spline Input	NDK217F
	N1860	Prior to 11/93 w/ New 46 Spline Input	NDK4395
	N1860	After 11/93	NDK4396
	P1888	Prior to 11/93	NDK4405
	P1888	After 11/93	NDK4406
	R1890	Prior to 11/93	NDK4405
	R1890	After 11/93	NDK4405
	S1917	Prior to 11/93 w/ Original 39 Spline Input	NDK217F
	S1917	Prior to 11/93 w/ New 46 Spline Input	NDK4395
	S1917	After 11/93	NDK4396
	T1814	Prior to 11/93 w/ Original 39 Spline Input	NDK217F
	T1814	Prior to 11/93 w/ New 46 Spline Input	NDK4395
	T1814	After 11/93	NDK4396
	U1815	Prior to 11/93	NDK4405
	U1815	After 11/93	NDK4406
	V1816	Prior to 11/93 w/ Original 39 Spline Input	NDK217F
	V1816	Prior to 11/93 w/ New 46 Spline Input	NDK4395
	V1816	After 11/93	NDK4396
	W1817	Prior to 11/93	NDK4405
	W1817	After 11/93	NDK4406
	X1662	Prior to 11/93 w/ Original 39 Spline Input	NDK217F
	X1662	Prior to 11/93 w/ New 46 Spline Input	NDK4395
	X1662	After 11/93	NDK4396
	<b>MT-44</b>		
			NDK4843
			NDK4844
<b>Not Identified</b>	R170	Exc. Ford from, ser 732,001	NDK50
	R170	all except 7.40 Ratio	NDK50
	R171	Exc. Ford from, ser 732,001	NDK50
	R173	Exc. Ford from, ser 732,001	NDK50
	RL170	Exc. Ford from, ser 732,001	NDK50
	S170	Exc. Ford from, ser 732,001	NDK50

MERITOR KIT APPS BY AXLE			
Axle Model	Carriers	Comments	Kit
<b>Not Identified</b>	SR170		NDK50
	SU170		NDK50
	SW170		NDK50
	W170		NDK50
	RS-17-220		NDK216
<b>Out of Production Single Reduction Axles – Single</b>	H172	3200-Y-1091	NDK4330
	H172		NDK4330
	H173		NDK4330
	L172		NDK4330
	L173		NDK4330
	P174		NDK4330
	R170	Prior to 12/1/83 exc. 7.40 Ratio	NDK50
	RL170	Prior to 12/1/83 exc. 7.40 Ratio	NDK50
	S170	Prior to 12/1/83 exc. 7.40 Ratio	NDK50
	W170		NDK50
<b>Out of Production Single Reduction Axles – Tandem</b>	SR170	All Ratios Exc. 7.40	NDK50
	SU170	All Ratios Exc. 7.40	NDK50
	SW170	All Ratios Exc. 7.40	NDK50
<b>P174</b>			NDK4330
<b>PL143</b>		Late	NDK172R
<b>PR250</b>			NDK172R
<b>PR300</b>		Late	NDK172R
<b>PR400</b>		Late	NDK172R
<b>PR400N</b>		Late	NDK172R
<b>PR500</b>			NDK172R
<b>PS300</b>		Late	NDK172R
<b>PS300W</b>		Late	NDK172R
<b>PS311</b>		Late	NDK172R
<b>PS350</b>		Late	NDK172R
<b>QT140</b>			NDK600
		Late	NDK600
<b>QT143</b>			NDK600
		Late	NDK600
<b>QT145</b>			NDK600
		Late	NDK600
<b>QT148</b>			NDK600
		Late	NDK600
<b>R100</b>			NDK172R
		Late	NDK172R
<b>R100A</b>			NDK172R
		Late	NDK172R
<b>R101</b>		Late	NDK172R
<b>R110</b>			NDK172R
<b>R110</b>			NDK172R
		Late	NDK172R
<b>R110A</b>			NDK172R
		Late	NDK172R
<b>R112</b>			NDK172R
<b>R112</b>			NDK172R
		Late	NDK172R
<b>R113</b>			NDK172R
<b>R113</b>			NDK172R
		Late	NDK172R
<b>R114</b>			NDK172R
<b>R114</b>			NDK172R
		Late	NDK172R
<b>R115</b>			NDK172R
<b>R115</b>			NDK172R
		Late	NDK172R
<b>R120</b>			NDK172R
<b>R120</b>			NDK172R
		Late	NDK172R
<b>R140</b>			NDK172R
<b>R140</b>			NDK172R
		Late	NDK172R

MERITOR KIT APPS BY AXLE			
Axle Model	Carriers	Comments	Kit
R141			NDK172R
		Late	NDK172R
R143			NDK172R
		Late	NDK172R
R155		Late	NDK172R
R164		Late	NDK172R
R170		W/Ford from series 732,001	NDK50A
	B-3200-G605	Ford series 732, and up	NDK50A
	3200-G-605, 32000E-603	7.40 Ratio only	NDK4130
		Prior to 12/1/83 7.40 Ratio	NDK4130
		12/1/83 & Later Exc. 7.40 Ratio	NDK4150
R171			NDK50A
		W/Ford from series 732,001	NDK50A
R173			NDK50A
		W/Ford from series 732,001	NDK50A
RA101A		Late	NDK172R
RC-23-160	A1821		NDK4426
	C1511		NDK4415
	C1823		NDK4428
	D1928		NDK4428
	E1825		NDK4428
	E1929		NDK4428
	H1854		NDK4426
	J1856		NDK4426
	P1706		NDK4426
	R1708		NDK4428
	T1658		NDK4415
	T1892		NDK4428
	V1660		NDK4415
	V1712		NDK4428
Y1897		NDK4428	
Z1560		NDK4415	
RD/RP-17-145		before 11/93	NDK217F
		After 11/93	NDK4396
RD/RP-20-145	3200-F-1645, 3200-X-1662, 3200-T-1814, 3200-V-1816	(before 11/93)	NDK217F
	3200-F-1645, 3200-X-1662, 3200-T-1814, 3200-V-1816	After 11/93	NDK4396
	3200-L-1624, 3200-M-1677, 3200-P-1888, 3200-R1890, 3200-D-1902	Prior to 11/93	NDK4405
	3200-L-1624, 3200-M-1677, 3200-P-1888, 3200-R1890, 3200-D-1902	After 11/93	NDK4406
RD/RP-22-145	3200-F-1645, 3200-X-1662, 3200-T-1814, 3200-V-1816	(before 11/93)	NDK217F
	3200-F-1645, 3200-X-1662, 3200-T-1814, 3200-V-1816	After 11/93	NDK4396
	3200-L-1624, 3200-M-1677, 3200-P-1888, 3200-R1890, 3200-D-1902	Prior to 11/93	NDK4405

MERITOR KIT APPS BY AXLE			
Axle Model	Carriers	Comments	Kit
RD/RP-22-145	3200-L-1624, 3200-M-1677, 3200-P-1888, 3200-R1890, 3200-D-1902	After 11/93	NDK4406
RD/RP-23-160	3200-K-1701, 3200-M-1703, 3200-X-1818, 3200-Z-1820, 3200-V-1894		NDK4422
	3200-P-1628, 3200-J-1648		NDK4420
	3200-W-1713, 3200-Y-1819, 3200-W-1895		NDK4423
RD/RP-26-160	3200-K-1701, 3200-M-1703, 3200-X-1818, 3200-Z-1820, 3200-V-1894		NDK4422
	3200-P-1628, 3200-J-1648		NDK4420
	3200-W-1713, 3200-Y-1819, 3200-W-1895		NDK4423
RD-23-180	3200-W-1791, 3200-J-1804, 3200-A-1899	6.83, 7.17, 7.40 ratios only	NDK4438
RL170		W/Ford from series 732,001	NDK50A
		Prior to 12/1/83 7.40 Ratio	NDK4130
		12/1/83 & Later Exc. 7.40 Ratio	NDK4150
RR/RS-23-160	3200-C-1511, 3200-Z-1560, 3200-T-1658, 3200-V-1660		NDK4415
	3200-P-1706		NDK4426
RR/RS-26-160	3200-R-1708, 3200-V-1712, 3200-C-1823, 3200-E-1825, 3200-T-1892, 3200-Y-1897		NDK4428
RR-17-145			NDK217R
RR-19-144	D1850		NDK217R
	D1850		NDK4400
	E1851		NDK217R
	E1851		NDK4400
	G1879		NDK4390
	L1676		NDK217R
	L1676		NDK4400
	M1885		NDK217R
	M1885		NDK4400
	Q1785		NDK217R
	Q1785		NDK4400
	S1865		NDK217R
	S1865		NDK4400
	X1558		NDK4390



MERITOR KIT APPS BY AXLE			
Axle Model	Carriers	Comments	Kit
RR-20-140	3200-L-1676, 3200-Q-1785, 3200-S-1865		NDK217R
	3200-L-1676, 3200-Q-1785, 3200-S-1865		NDK4400
RR-20-145	3200-L-1676, 3200-Q-1785, 3200-S-1865		NDK217R
	3200-L-1676, 3200-Q-1785, 3200-S-1865		NDK4400
	3200-M-1547, 3200-x-1558, 3200-G-1879		NDK4390
RR-22-145	3200-L-1676, 3200-Q-1785, 3200-S-1865,		NDK217R
	3200-L-1676, 3200-Q-1785, 3200-S-1865,		NDK4400
	3200-X-1558, 3200-G-1879		NDK4390
RR-24-180	3200-U-1399	all except 6.83, 7.17 & 7.40	NDK4435
	3200-U-1399	6.83, 7.17 & 7.40 Ratios	NDK4436
RR-26-180	3200-U-1399	all except 6.83, 7.17 & 7.41	NDK4435
	3200-U-1399	6.83, 7.17 & 7.40 Ratios	NDK4436
RR-29-180	3200-U-1399	all except 6.83, 7.17 & 7.42	NDK4435
	3200-U-1399	6.83, 7.17 & 7.40 Ratios	NDK4436
RS-13-120			NDK218
RS-15-120			NDK218
RS-15-125			NDK218
RS-15-210	All		NDK216
	All		NDK4375
RS-16-141	All		NDK217R
	All		NDK4400
RS-17-141	All		NDK217R
	All		NDK4400
RS-17-144	D1850		NDK217R
	D1850		NDK4400
	E1851		NDK217R
	E1851		NDK4400
	G1879		NDK4390
	L1676		NDK217R
	L1676		NDK4400
	M1885		NDK217R
	M1885		NDK4400
	Q1785		NDK217R
	Q1785		NDK4400
	S1895		NDK217R
	S1895		NDK4400
RS-17-145	X1558		NDK4390
RS-17-220			NDK216
RS-19-144	All		NDK217R
	All		NDK4400
	D1850		NDK217R
	D1850		NDK4400
	G1879		NDK4390
	L1676		NDK217R
	L1676		NDK4400
	M1885		NDK217R
	M1885		NDK4400
	Q1785		NDK217R
	Q1785		NDK4400
	S1895		NDK217R

MERITOR KIT APPS BY AXLE			
Axle Model	Carriers	Comments	Kit
RS-19-144	S1895		NDK4400
	X1558		NDK4390
RS-19-145	All		NDK217R
	All		NDK4400
	E1851		NDK217R
RS-20-160	E1851		NDK4400
	A1821		NDK4426
	C1511		NDK4415
	C1823		NDK4428
	D1928		NDK4428
	E1825		NDK4428
	E1929		NDK4428
	H1854		NDK4426
	J1856		NDK4426
	P1706		NDK4426
	R1708		NDK4428
	T1658		NDK4415
	T1892		NDK4428
	V1660		NDK4415
	V1712		NDK4428
	Y1897		NDK4428
	Z1560		NDK4415
RS-21-145	3200-L-1676, 3200-Q-1785, 3200-S-1865		NDK217R
	3200-L-1676, 3200-Q-1785, 3200-S-1865		NDK4400
	3200-M-1547, 3200-x-1558, 3200-G-1879		NDK4390
	D1850		NDK217R
	D1850		NDK4400
	E1851		NDK217R
	E1851		NDK4400
	G1879		NDK4390
	L1676		NDK217R
	L1676		NDK4400
	M1885		NDK217R
	M1885		NDK4400
	Q1785		NDK217R
	Q1785		NDK4400
	S1895		NDK217R
	S1895		NDK4400
	X1558		NDK4390
RS-21-160	A1821		NDK4426
	C1511		NDK4415
	C1823		NDK4428
	D1928		NDK4428
	E1825		NDK4428
	E1929		NDK4428
	H1854		NDK4426
	J1856		NDK4426
	P1706		NDK4426
	P1708		NDK4428
	T1658		NDK4415
	T1892		NDK4428
	V1660		NDK4415
V1712		NDK4428	
Y1897		NDK4428	
Z1560		NDK4415	
RS-23-160	A1821		NDK4426
	C1511		NDK4415

MERITOR KIT APPS BY AXLE			
Axle Model	Carriers	Comments	Kit
RS-23-160	C1823		NDK4428
	D1928		NDK4428
	E1825		NDK4428
	E1929		NDK4428
	H1854		NDK4426
	J1856		NDK4426
	P1706		NDK4426
	R1708		NDK4428
	T1658		NDK4415
	T1892		NDK4428
	V1660		NDK4415
	V1712		NDK4428
	Y1897		NDK4428
Z1560		NDK4415	
RS-23-161	3200-C-1511, 3200-Z-1560, 3200-T-1658, 3200-V-1660		NDK4415
	3200-P-1706		NDK4426
	3200-R-1708, 3200-V-1712, 3200-C-1823, 3200-E-1825, 3200-T-1892, 3200-Y-1897		NDK4428
	A1821		NDK4426
	C1511		NDK4415
	C1823		NDK4428
	D1928		NDK4428
	E1825		NDK4428
	E1929		NDK4428
	H1854		NDK4426
	J1856		NDK4426
	P1706		NDK4426
	R1708		NDK4428
	T1658		NDK4415
	T1892		NDK4428
	V1660		NDK4415
	V1712		NDK4428
	Y1897		NDK4428
	Z1560		NDK4415
	RS-23-180	3200-U-1399	6.83, 7.17 & 7.40 Ratios
3200-U-1399		all except 6.83, 7.17 & 7.40	NDK4435
3200-W-1791, 3200-J-1804, 3200-A-1899		all except 6.83, 7.17 & 7.40	NDK4437
A1899		All Other Ratios	NDK4437
A1899		6.83, 7.17, 7.40 & 7.83 Ratios	NDK4438
C1381		All Other Ratios	NDK4435
C1381		6.83, 7.17, 7.40 & 7.83 Ratios	NDK4436
J1804		All Other Ratios	NDK4437
J1804		6.83, 7.17, 7.40 & 7.83 Ratios	NDK4438
K1753		All Other Ratios	NDK4435
K1753		6.83, 7.17, 7.40 & 7.83 Ratios	NDK4436
U1399		All Other Ratios	NDK4435
U1399		6.83, 7.17, 7.40 & 7.83 Ratios	NDK4436
W1791		All Other Ratios	NDK4437
W1791		6.83, 7.17, 7.40 & 7.83 Ratios	NDK4438
RS-23-185	A1899	All Other Ratios	NDK4437
	A1899	6.83, 7.17, 7.40 & 7.83 Ratios	NDK4438
	C1381	All Other Ratios	NDK4435
	C1381	6.83, 7.17, 7.40 & 7.83 Ratios	NDK4436
	J1804	All Other Ratios	NDK4437
	J1804	6.83, 7.17, 7.40 & 7.83 Ratios	NDK4438
	J1804	All Other Ratios	NDK4437

MERITOR KIT APPS BY AXLE			
Axle Model	Carriers	Comments	Kit
RS-23-185	K1753	All Other Ratios	NDK4435
	K1753	6.83, 7.17, 7.40 & 7.83 Ratios	NDK4436
	U1399	All Other Ratios	NDK4435
	U1399	6.83, 7.17, 7.40 & 7.83 Ratios	NDK4436
	W1791	All Other Ratios	NDK4437
	W1791	6.83, 7.17, 7.40 & 7.83 Ratios	NDK4438
	RS-23-186	A1899	All Other Ratios
A1899		6.83, 7.17, 7.40 & 7.83 Ratios	NDK4438
C1381		All Other Ratios	NDK4435
C1381		6.83, 7.17, 7.40 & 7.83 Ratios	NDK4436
J1804		All Other Ratios	NDK4437
J1804		6.83, 7.17, 7.40 & 7.83 Ratios	NDK4438
K1753		All Other Ratios	NDK4435
K1753		6.83, 7.17, 7.40 & 7.83 Ratios	NDK4436
U1399		All Other Ratios	NDK4435
U1399		6.83, 7.17, 7.40 & 7.83 Ratios	NDK4436
W1791		All Other Ratios	NDK4437
W1791	6.83, 7.17, 7.40 & 7.83 Ratios	NDK4438	
RS-23-240	3200-F-1566		NDK4375
RS-23-380	M1833	All Other Ratios	NDK4441
RS-24-160	A1821		NDK4426
	C1511		NDK4415
	C1823		NDK4428
	D1928		NDK4428
	E1825		NDK4428
	E1929		NDK4428
	H1854		NDK4426
	J1856		NDK4426
	P1706		NDK4426
	R1708		NDK4428
	T1658		NDK4415
	T1892		NDK4428
	V1660		NDK4415
	V1712		NDK4428
	Y1897		NDK4428
Z1560		NDK4415	
RS-25-160	A1821		NDK4426
	C1511		NDK4415
	C1823		NDK4428
	D1928		NDK4428
	E1825		NDK4428
	E1929		NDK4428
	H1854		NDK4426
	J1856		NDK4426
	P1706		NDK4426
	R1708		NDK4428
	T1658		NDK4415
	T1892		NDK4428
	V1660		NDK4415
	V1712		NDK4428
	Y1897		NDK4428
Z1560		NDK4415	
RS-26-160	A1821		NDK4426
	C1511		NDK4415
	C1823		NDK4428
	D1928		NDK4428
	E1825		NDK4428
	E1929		NDK4428
	H1854		NDK4426
	J1856		NDK4426
	P1706		NDK4426
	R1708		NDK4428

MERITOR KIT APPS BY AXLE			
Axle Model	Carriers	Comments	Kit
RS-26-160	T1658		NDK4415
	T1892		NDK4428
	V1660		NDK4415
	V1712		NDK4428
	Y1897		NDK4428
	Z1560		NDK4415
RS-26-180	A1899	All Other Ratios	NDK4437
	A1899	6.83, 7.17, 7.40 & 7.83 Ratios	NDK4438
	C1381	All Other Ratios	NDK4435
	J1804	All Other Ratios	NDK4437
	J1804	6.83, 7.17, 7.40 & 7.83 Ratios	NDK4438
	U1399	All Other Ratios	NDK4435
	U1399	6.83, 7.17, 7.40 & 7.83 Ratios	NDK4436
	W1791	All Other Ratios	NDK4437
W1791	6.83, 7.17, 7.40 & 7.83 Ratios	NDK4438	
RS-26-185	A1899	All Other Ratios	NDK4437
	A1899	6.83, 7.17, 7.40 & 7.83 Ratios	NDK4438
	C1381	All Other Ratios	NDK4435
	J1804	All Other Ratios	NDK4437
	J1804	6.83, 7.17, 7.40 & 7.83 Ratios	NDK4438
	U1399	All Other Ratios	NDK4435
	U1399	6.83, 7.17, 7.40 & 7.83 Ratios	NDK4436
	W1791	All Other Ratios	NDK4437
W1791	6.83, 7.17, 7.40 & 7.83 Ratios	NDK4438	
RS-26-380	M1833	All Other Ratios	NDK4441
RS-30-180	A1899	All Other Ratios	NDK4437
	A1899	6.83, 7.17, 7.40 & 7.83 Ratios	NDK4438
	C1381	6.83, 7.17, 7.40 & 7.83 Ratios	NDK4436
	C1381	All Other Ratios	NDK4438
	J1804	All Other Ratios	NDK4437
	J1804	6.83, 7.17, 7.40 & 7.83 Ratios	NDK4438
	K1753	All Other Ratios	NDK4435
	K1753	6.83, 7.17, 7.40 & 7.83 Ratios	NDK4436
	U1399	All Other Ratios	NDK4435
	U1399	6.83, 7.17, 7.40 & 7.83 Ratios	NDK4436
	W1791	All Other Ratios	NDK4437
W1791	6.83, 7.17, 7.40 & 7.83 Ratios	NDK4438	
RS-30-185	A1899	All Other Ratios	NDK4437
	A1899	6.83, 7.17, 7.40 & 7.83 Ratios	NDK4438
	C1381	All Other Ratios	NDK4435
	C1381	6.83, 7.17, 7.40 & 7.83 Ratios	NDK4436
	J1804	All Other Ratios	NDK4437
	J1804	6.83, 7.17, 7.40 & 7.83 Ratios	NDK4438
	K1753	All Other Ratios	NDK4435
	K1753	6.83, 7.17, 7.40 & 7.83 Ratios	NDK4436
	U1399	All Other Ratios	NDK4435
	U1399	6.83, 7.17, 7.40 & 7.83 Ratios	NDK4436
	W1791	All Other Ratios	NDK4437
W1791	6.83, 7.17, 7.40 & 7.83 Ratios	NDK4438	
RS-30-380	M1833	All Other Ratios	NDK4441
RT140		Late	NDK172R
RT-34-144	B1978	Prior to 11/93 w/ Original 39 Spline Input	NDK217F
	B1978	Prior to 11/93 w/ New 46 Spline Input	NDK4395
	B1978	After 11/93	NDK4396
	C1979	Prior to 11/93 w/ Original 39 Spline Input	NDK217F
	C1979	Prior to 11/93 w/ New 46 Spline Input	NDK4395
	C1979	After 11/93	NDK4396
	D1850		NDK217R
	D1850		NDK4400

MERITOR KIT APPS BY AXLE			
Axle Model	Carriers	Comments	Kit
RT-34-144	D1902	Prior to 11/93	NDK4405
	D1902	After 11/93	NDK4406
	E1851		NDK217R
	E1851		NDK4400
	E1903	Prior to 11/93	NDK4405
	E1903	After 11/93	NDK4406
	E1981	Prior to 11/93	NDK4405
	E1981	After 11/93	NDK4406
	F1852	Prior to 11/93 w/ Original 39 Spline Input	NDK217F
	F1852	Prior to 11/93 w/ New 46 Spline Input	NDK4395
	F1852	After 11/93	NDK4396
	G1645	Prior to 11/93 w/ Original 39 Spline Input	NDK217F
	G1645	Prior to 11/93 w/ New 46 Spline Input	NDK4395
	G1645	After 11/93	NDK4396
	G1853	Prior to 11/93 w/ Original 39 Spline Input	NDK217F
	G1853	Prior to 11/93 w/ New 46 Spline Input	NDK4395
	G1853	After 11/93	NDK4396
	G1879		NDK4390
	H1984	Prior to 11/93 w/ Original 39 Spline Input	NDK217F
	H1984	Prior to 11/93 w/ New 46 Spline Input	NDK4396
	H1984	After 11/93	NDK4396
	K1987	Prior to 11/93	NDK4405
	K1987	After 11/93	NDK4406
	L164	After 11/93	NDK4406
	L1624	Prior to 11/93	NDK4405
	L1676		NDK217R
	L1676		NDK4400
	M1677	Prior to 11/93	NDK4405
	M1677	After 11/93	NDK4406
	M1885		NDK217R
	M1885		NDK4400
	N1860	Prior to 11/93 w/ Original 39 Spline Input	NDK217F
	N1860	Prior to 11/93 w/ New 46 Spline Input	NDK4395
	N1860	After 11/93	NDK4396
P1888	Prior to 11/93	NDK4405	
P1888	After 11/93	NDK4406	
Q1785		NDK217R	
Q1785		NDK4400	
R1890	Prior to 11/93	NDK4405	
R1890	After 11/93	NDK4406	
S1865		NDK217R	
S1865		NDK4400	
S1917	Prior to 11/93 w/ Original 39 Spline Input	NDK217F	
S1917	Prior to 11/93 w/ New 46 Spline Input	NDK4395	
S1917	After 11/93	NDK4396	
T1814	Prior to 11/93 w/ Original 39 Spline Input	NDK217F	
T1814	Prior to 11/93 w/ New 46 Spline Input	NDK4395	
T1814	After 11/93	NDK4396	
U1815	Prior to 11/93	NDK4405	
U1815	After 11/93	NDK4406	

MERITOR KIT APPS BY AXLE			
Axle Model	Carriers	Comments	Kit
RT-34-144	V1816	Prior to 11/93 w/ Original 39 Spline Input	NDK217F
	V1816	Prior to 11/93 w/ New 46 Spline Input	NDK4395
	V1816	After 11/93	NDK4396
	W1817	Prior to 11/93	NDK4405
	W1817	After 11/93	NDK4406
	X1558		NDK4390
	X1662	Prior to 11/93 w/ Original 39 Spline Input	NDK217F
	X1662	Prior to 11/93 w/ New 46 Spline Input	NDK4395
	X1662	After 11/93	NDK4396
RT-34-145	All	Prior to 11/93 w/ Original 39 Spline Input	NDK217F
		before 11/93	NDK217F
	All		NDK217R
	All	Prior to 11/93 w/ New 46 Spline Input	NDK4395
	All	Prior to 11/93	NDK4395
	All	After 11/93	NDK4396
	All	After 11/93	NDK4396
RT-35-145		After 11/93	NDK4396
RT-38-144	B1978	Prior to 11/93 w/ New 46 Spline Input	NDK4395
	B1978	After 11/93	NDK4396
	C1979	Prior to 11/93 w/ Original 39 Spline Input	NDK217F
	C1979	Prior to 11/93 w/ New 46 Spline Input	NDK4395
	C1979	After 11/93	NDK4396
	D1902	Prior to 11/93	NDK4405
	D1902	After 11/93	NDK4406
	E1903	Prior to 11/93	NDK4405
	E1903	After 11/93	NDK4406
	E1981	Prior to 11/93	NDK4405
	E1981	After 11/93	NDK4406
	F1852	Prior to 11/93 w/ Original 39 Spline Input	NDK217F
	F1852	Prior to 11/93 w/ New 46 Spline Input	NDK4395
	F1852	After 11/93	NDK4396
	G1645	Prior to 11/93 w/ Original 39 Spline Input	NDK217F
	G1645	Prior to 11/93 w/ New 46 Spline Input	NDK4395
	G1645	After 11/93	NDK4396
	G1853	Prior to 11/93 w/ Original 39 Spline Input	NDK217F
	G1853	Prior to 11/93 w/ New 46 Spline Input	NDK4395
	G1853	After 11/93	NDK4396
	H1984	Prior to 11/93 w/ Original 39 Spline Input	NDK217F
	H1984	Prior to 11/93 w/ New 46 Spline Input	NDK4395
	H1984	After 11/93	NDK4396
	K1987	Prior to 11/93	NDK4405
	K1987	After 11/93	NDK4406
	L1624	Prior to 11/93	NDK4405
	L1624	After 11/93	NDK4406
	M1677	Prior to 11/93	NDK4405
	M1677	After 11/93	NDK4406
	N1860	Prior to 11/93 w/ Original 39 Spline Input	NDK217F

MERITOR KIT APPS BY AXLE			
Axle Model	Carriers	Comments	Kit
RT-38-144	N1860	Prior to 11/93 w/ New 46 Spline Input	NDK4395
	N1860	After 11/93	NDK4396
	P1888	Prior to 11/93	NDK4405
	P1888	After 11/93	NDK4406
	R1890	Prior to 11/93	NDK4405
	R1890	After 11/93	NDK4406
	S1917	Prior to 11/93 w/ Original 39 Spline Input	NDK217F
	S1917	Prior to 11/93 w/ New 46 Spline Input	NDK4395
	S1917	After 11/93	NDK4396
	T1814	Prior to 11/93 w/ Original 39 Spline Input	NDK217F
	T1814	Prior to 11/93 w/ New 46 Spline Input	NDK4395
	T1814	After 11/93	NDK4396
	U1815	Prior to 11/93	NDK4405
	U1815	After 11/93	NDK4406
	V1816	Prior to 11/93 w/ Original 39 Spline Input	NDK217F
	V1816	Prior to 11/93 w/ New 46 Spline Input	NDK4395
	V1816	After 11/93	NDK4396
	W1817	Prior to 11/93	NDK4405
	W1817	After 11/93	NDK4406
	RT-40-140		3200-L-1676, 3200-Q-1785, 3200-S-1865
		3200-L-1676, 3200-Q-1785, 3200-S-1865	NDK4400
		All	NDK217R
		All	NDK4400
RT-40-145		3200-G-1645, 3200-X-1662, 3200-T-1814, 3200-V-1816	After 11/93
		3200-L-1624, 3200-M-1677, 3200-P-1888, 3200R-1890, 3200-D-1902	Prior to 11/93
		3200-L-1624, 3200-M-1677, 3200-P-1888, 3200R-1890, 3200-D-1902	After 11/93
		3200-L-1676, 3200-Q-1785, 3200-S-1865	
		3200-L-1676, 3200-Q-1785, 3200-S-1865	
		3200-x-1547, 3200-x-1558, 3200-G-1879	
	B1978	Prior to 11/93 w/ Original 39 Spline Input	NDK217F
	B1978	Prior to 11/93 w/ New 46 Spline Input	NDK4395
	B1978	After 11/93	NDK4396
	C1979	Prior to 11/93 w/ Original 39 Spline Input	NDK217F

MERITOR KIT APPS BY AXLE			
Axle Model	Carriers	Comments	Kit
<b>RT-40-145</b>	C1979	Prior to 11/93 w/ New 46 Spline Input	NDK4395
	C1979	After 11/93	NDK4396
	D1850		NDK217R
	D1850		NDK4400
	D1902	Prior to 11/93	NDK4405
	D1902	After 11/93	NDK4406
	E1851		NDK217R
	E1851		NDK4400
	E1903	Prior to 11/93	NDK4405
	E1903	After 11/93	NDK4406
	E1981	Prior to 11/93	NDK4405
	E1981	After 11/93	NDK4406
	F1852	Prior to 11/93 w/ Original 39 Spline Input	NDK217F
	F1852	Prior to 11/93 w/ New 46 Spline Input	NDK4395
	F1852	After 11/93	NDK4396
	G1645	Prior to 11/93 w/ Original 39 Spline Input	NDK217F
	G1645	Prior to 11/93 w/ New 46 Spline Input	NDK4395
	G1645	After 11/93	NDK4396
	G1853	Prior to 11/93 w/ Original 39 Spline Input	NDK217F
	G1853	Prior to 11/93 w/ New 46 Spline Input	NDK4395
	G1853	After 11/93	NDK4396
	G1879		NDK4390
	H1984	Prior to 11/93 w/ Original 39 Spline Input	NDK217F
	H1984	Prior to 11/93 w/ New 46 Spline Input	NDK4395
	H1984	After 11/93	NDK4396
	K1987	Prior to 11/93	NDK4405
	K1987	After 11/93	NDK4406
	L1624	Prior to 11/93	NDK4405
	L1624	After 11/93	NDK4406
	L1676		NDK217R
	L1676		NDK4400
	M1677	Prior to 11/93	NDK4405
	M1677	After 11/93	NDK4405
	M1885		NDK217R
	M1885		NDK4400
	N1860	Prior to 11/93 w/ Original 39 Spline Input	NDK217F
	N1860	Prior to 11/93 w/ New 46 Spline Input	NDK4395
	N1860	After 11/93	NDK4396
	P1888	Prior to 11/93	NDK4405
	P1888	After 11/93	NDK4406
	Q1785		NDK217R
	Q1785		NDK4400
	R1890	Prior to 11/93	NDK4405
	R1890	After 11/93	NDK4406
	S1865		NDK217R
	S1865		NDK4400
	S1917	Prior to 11/93 w/ Original 39 Spline Input	NDK217F
	S1917	Prior to 11/93 w/ New 46 Spline Input	NDK4395
S1917	After 11/93	NDK4396	
T1814	Prior to 11/93 w/ Original 39 Spline Input	NDK217F	

MERITOR KIT APPS BY AXLE				
Axle Model	Carriers	Comments	Kit	
<b>RT-40-145</b>	T1814	Prior to 11/93 w/ New 46 Spline Input	NDK4395	
	T1814	After 11/93	NDK4396	
	U1815	Prior to 11/93	NDK4405	
	U1815	After 11/93	NDK4406	
	V1816	Prior to 11/93 w/ Original 39 Spline Input	NDK217F	
	V1816	Prior to 11/93 w/ New 46 Spline Input	NDK4395	
	V1816	After 11/93	NDK4396	
	W1817	Prior to 11/93	NDK4405	
	W1817	After 11/93	NDK4406	
	X1558		NDK4390	
	X1662	Prior to 11/93 w/ Original 39 Spline Input	NDK217F	
	X1662	Prior to 11/93 w/ New 46 Spline Input	NDK4395	
	X1662	After 11/93	NDK4396	
		3200-G-1645, 3200-X-1662, 3200-T-1814, 3200-V-1816	before 11/93	NDK217F
		A1821		NDK4426
		C1511		NDK4415
		C1823		NDK4428
	<b>RT-40-160</b>		D1928	NDK4428
		E1825	NDK4428	
		E1929	NDK4428	
		H1854	NDK4426	
		J1648	NDK4420	
		J1856	NDK4426	
		J2116	NDK4422	
		K1701	NDK4423	
		K1857	NDK4422	
		K2117	NDK4423	
		L2118	NDK4423	
		M1703	NDK4422	
		P1628	NDK4420	
		P1706	NDK4426	
		Q1837	NDK4422	
		R1708	NDK4428	
		T1658	NDK4415	
		T1892	NDK4428	
		V1660	NDK4415	
		V1712	NDK4428	
		V1894	NDK4423	
		W1713	NDK4423	
		W1895	NDK4423	
		X1818	NDK4422	
	Y1819	NDK4423		
	Y1897	NDK4428		
	Z1560	NDK4415		
	Z1820	NDK4423		
<b>RT-44-145</b>		3200-G-1645, 3200-X-1662, 3200-T-1814, 3200-V-1816	After 11/93	
		3200-L-1624, 3200-M-1677, 3200-P-1888, 3200R-1890, 3200-D-1902	Prior to 11/93	

MERITOR KIT APPS BY AXLE			
Axle Model	Carriers	Comments	Kit
RT-44-145	3200-L-1624, 3200-M-1677, 3200-P-1888, 3200R-1890, 3200-D-1902	After 11/93	NDK4406
	3200-L-1676, 3200-Q-1785, 3200-S-1865		NDK217R
	3200-L-1676, 3200-Q-1785, 3200-S-1865		NDK4400
	3200-M-1547, 3200-x-1558, 3200-G-1879		NDK4390
	A1873		NDK217R
	A1873		NDK4400
	B1874	Prior to 11/93 w/ Original 39 Spline Input	NDK217F
	B1874	Prior to 11/93 w/ New 46 Spline Input	NDK4395
	B1874	After 11/93	NDK4396
	C1875	Prior to 11/93	NDK4405
	C1875	After 11/93	NDK4406
	D1876	Prior to 11/93 w/ Original 39 Spline Input	NDK217F
	D1876	Prior to 11/93 w/ New 46 Spline Input	NDK4395
	D1876	After 11/93	NDK4396
	D1980	Prior to 11/93 w/ Original 39 Spline Input	NDK217F
	D1980	Prior to 11/93 w/ New 46 Spline Input	NDK4395
	D1980	After 11/93	NDK4396
	E1877	Prior to 11/93	NDK4405
	E1877	After 11/93	NDK4406
	F1904		NDK4390
	F1982	Prior to 11/93	NDK4405
	F1982	After 11/93	NDK4406
	G1905	Prior to 11/93	NDK4405
	G1905	After 11/93	NDK4406
	H1906	Prior to 11/93	NDK4405
	H1906	After 11/93	NDK4406
	J1986	Prior to 11/93 w/ Original 39 Spline Input	NDK217F
	J1986	Prior to 11/93 w/ New 46 Spline Input	NDK4395
	J1986	After 11/93	NDK4396
	M1911	Prior to 11/93	NDK4405
	M1911	After 11/93	NDK4406
	P1914	Prior to 11/93 w/ Original 39 Spline Input	NDK217F
P1914	Prior to 11/93 w/ New 46 Spline Input	NDK4395	
P1914	After 11/93	NDK4396	
T1918	Prior to 11/93	NDK4405	
T1918	After 11/93	NDK4406	
RT-46-160	3200-G-1645, 3200-X-1662, 3200-T-1814, 3200-V-1816	before 11/93	NDK217F
	3200-C-1511, 3200-Z-1560, 3200-T-1658, 3200-V-1660		NDK4415

MERITOR KIT APPS BY AXLE				
Axle Model	Carriers	Comments	Kit	
RT-46-160	3200-K-1701, 3200-M-1703, 3200-X-1818, 3200-Z-1820, 3200-V-1894		NDK4422	
	3200-P-1628, 3200-J-1648		NDK4420	
	3200-P-1706		NDK4426	
	3200-R-1708, 3200-V-1712, 3200-C-1823, 3200-E-1825, 3200-T-1892, 3200-Y-1897		NDK4428	
	3200-W-1713, 3200-Y-1819, 3200-W-1895		NDK4423	
	A1821		NDK4426	
	C1511		NDK4415	
	C1823		NDK4428	
	D1928		NDK4428	
	E1825		NDK4428	
	E1929		NDK4428	
	H1854		NDK4426	
	J1648		NDK4420	
	J1856		NDK4426	
	J2116		NDK4422	
	K1701		NDK4423	
	K1857		NDK4422	
	K2117		NDK4423	
	L2118		NDK4423	
	M1703		NDK4422	
	P1628		NDK4420	
	P1706		NDK4426	
	Q1837		NDK4422	
	R1708		NDK4428	
	T1658		NDK4415	
	T1892		NDK4428	
	V1660		NDK4415	
	V1712		NDK4428	
	V1894		NDK4423	
	W1713		NDK4423	
	W1895		NDK4423	
	X1818		NDK4422	
	Y1819		NDK4423	
	Y1897		NDK4428	
	Z1560		NDK4415	
	Z1820		NDK4423	
	RT-46-164	A1821		NDK4426
		C1511		NDK4415
		C1823		NDK4428
		D1928		NDK4428
		E1825		NDK4428
		E1929		NDK4428
H1854			NDK4426	
J1648			NDK4420	
J1856			NDK4426	
J2116			NDK4422	
K1701			NDK4423	
K1857			NDK4422	
K2117			NDK4423	
L2118			NDK4423	
M1703			NDK4422	
P1628			NDK4420	

MERITOR KIT APPS BY AXLE			
Axle Model	Carriers	Comments	Kit
RT-46-164	P1706		NDK4426
	Q1837		NDK4422
	R1708		NDK4428
	T1658		NDK4415
	T1892		NDK4428
	V1660		NDK4415
	V1712		NDK4428
	V1894		NDK4423
	W1713		NDK4423
	W1895		NDK4423
	X1818		NDK4422
	Y1819		NDK4423
	Y1897		NDK4428
	Z1560		NDK4415
Z1820		NDK4423	
RT-48-180	3200-M-1625	6.83, 7.17 & 7.40 Ratios	NDK4440
	3200-M-1833		NDK4441
	3200-U-1399	all except 6.83, 7.17 & 7.40	NDK4435
	3200-U-1399	6.83, 7.17 & 7.40 Ratios	NDK4436
	3200-W-1791, 3200-J-1804, 3200-A-1899		NDK4437
	3200-W-1791, 3200-J-1804, 3200-A-1899	6.83, 7.17 & 7.40 Ratios	NDK4438
	A1899	All Other Ratios	NDK4437
	A1899	6.83, 7.17, 7.40 & 7.83 Ratios	NDK4438
	C1381	All Other Ratios	NDK4435
	C1381	6.83, 7.17, 7.40 & 7.83 Ratios	NDK4436
	J1804	All Other Ratios	NDK4437
	J1804	6.83, 7.17, 7.40 & 7.83 Ratios	NDK4438
	M1625	All Ratios	NDK4440
	M1833	All Other Ratios	NDK4441
	U1399	All Other Ratios	NDK4435
	U1399	6.83, 7.17, 7.40 & 7.83 Ratios	NDK4436
	W1791	All Other Ratios	NDK4437
	W1791	6.83, 7.17, 7.40 & 7.83 Ratios	NDK4438
RT-48-185	A1899	All Other Ratios	NDK4437
	A1899	6.83, 7.17, 7.40 & 7.83 Ratios	NDK4438
	C1381	All Other Ratios	NDK4435
	C1381	6.83, 7.17, 7.40 & 7.83 Ratios	NDK4436
	M1625	All Ratios	NDK4440
	M1833	All Other Ratios	NDK4441
	J1804	All Other Ratios	NDK4437
	J1804	6.83, 7.17, 7.40 & 7.83 Ratios	NDK4438
	U1399	All Other Ratios	NDK4435
	U1399	6.83, 7.17, 7.40 & 7.83 Ratios	NDK4436
	W1791	All Other Ratios	NDK4437
	W1791	6.83, 7.17, 7.40 & 7.83 Ratios	NDK4438
RT-48-380	All		NDK4440
	3200-M-1625		NDK4440
	M1833	All Other Ratios	NDK4441
	3200-M-1833		NDK4441
RT-50-160	A1821		NDK4426
	C1511		NDK4415
	C1823		NDK4428
	D1928		NDK4428
	E1825		NDK4428
	E1929		NDK4428
	H1854		NDK4426
	J1648		NDK4420
J1856		NDK4426	

MERITOR KIT APPS BY AXLE			
Axle Model	Carriers	Comments	Kit
RT-50-160	J2116		NDK4422
	K1701		NDK4423
	K1857		NDK4422
	K2117		NDK4423
	L2118		NDK4423
	M1703		NDK4422
	P1628		NDK4420
	P1706		NDK4426
	Q1837		NDK4422
	R1708		NDK4428
	T1658		NDK4415
	T1892		NDK4428
	V1660		NDK4415
	V1712		NDK4428
	V1894		NDK4423
	W1713		NDK4423
	W1895		NDK4423
	X1818		NDK4422
	Y1819		NDK4423
	Y1897		NDK4428
Z1560		NDK4415	
Z1820		NDK4423	
RT-50-164	A1821		NDK4426
	C1511		NDK4415
	C1823		NDK4428
	D1928		NDK4428
	E1825		NDK4428
	E1929		NDK4428
	H1854		NDK4426
	J1648		NDK4420
	J1856		NDK4426
	J2116		NDK4422
	K1701		NDK4423
	K1857		NDK4422
	K2117		NDK4423
	L2118		NDK4423
	M1703		NDK4422
	P1628		NDK4420
	P1706		NDK4426
	Q1837		NDK4422
R1708		NDK4428	
T1658		NDK4415	
T1892		NDK4428	
V1660		NDK4415	
V1712		NDK4428	
V1894		NDK4423	
W1713		NDK4423	
W1895		NDK4423	
X1818		NDK4422	
Y1819		NDK4423	
Y1897		NDK4428	
Z1560		NDK4415	
Z1820		NDK4423	
RT-52-160	3200-C-1511, 3200-Z-1560, 3200-T-1658, 3200-V-1660		NDK4415
	3200-K-1701, 3200-M-1703, 3200-X-1818, 3200-Z-1820, 3200-V-1894		NDK4422

MERITOR KIT APPS BY AXLE			
Axle Model	Carriers	Comments	Kit
RT-52-160	3200-P-1628, 3200-J-1648		NDK4420
	3200-P-1706		NDK4426
	3200-R-1708, 3200-V-1712, 3200-C-1823, 3200-E-1825, 3200-T-1892, 3200-Y-1897		NDK4428
	3200-W-1713, 3200-Y-1819, 3200-W-1895		NDK4423
	A1821		NDK4426
	C1511		NDK4415
	C1823		NDK4428
	D1928		NDK4428
	E1825		NDK4428
	E1929		NDK4428
	H1854		NDK4426
	J1648		NDK4420
	J1856		NDK4426
	J2116		NDK4422
	K1701		NDK4423
	K1857		NDK4422
	K2117		NDK4423
	L2118		NDK4423
	M1703		NDK4422
	P1628		NDK4420
	P1706		NDK4426
	Q1837		NDK4422
	R1708		NDK4428
	T1658		NDK4415
	T1892		NDK4428
	V1660		NDK4415
	V1712		NDK4428
	V1894		NDK4423
	W1713		NDK4423
	W1895		NDK4423
	X1818		NDK4422
	Y1819		NDK4423
Y1897		NDK4428	
Z1560		NDK4415	
Z1820		NDK4423	
RT-52-164	A1821		NDK4426
	C1511		NDK4415
	C1823		NDK4428
	D1928		NDK4428
	E1825		NDK4428
	E1929		NDK4428
	H1854		NDK4426
	J1648		NDK4420
	J1856		NDK4426
	J2116		NDK4422
	K1701		NDK4423
	K1857		NDK4422
	K2117		NDK4423
	L2118		NDK4423
	M1703		NDK4422
	P1628		NDK4420
	P1706		NDK4426
	Q1837		NDK4422
	R1708		NDK4428
	T1658		NDK4415

MERITOR KIT APPS BY AXLE			
Axle Model	Carriers	Comments	Kit
RT-52-164	T1892		NDK4428
	V1660		NDK4415
	V1712		NDK4428
	V1894		NDK4423
	W1713		NDK4423
	W1895		NDK4423
	X1818		NDK4422
	Y1819		NDK4423
	Y1897		NDK4428
	Z1560		NDK4415
RT-52-180	3200-M-1625		NDK4440
	3200-M-1833		NDK4441
	3200-U-1399	all except 6.83, 7.17 & 7.40	NDK4435
	3200-U-1399	6.83, 7.17 & 7.40 Ratios	NDK4436
	3200-W-1791, 3200-J-1804, 3200-A-1899	6.83, 7.17 & 7.40 Ratios	NDK4438
	3200-W-1791, 3200-J-1804, 3200-A-1899		NDK4437
	A1899	All Other Ratios	NDK4437
	A1899	6.83, 7.17, 7.40 & 7.83 Ratios	NDK4438
	C1381	All Other Ratios	NDK4435
	C1381	6.83, 7.17, 7.40 & 7.83 Ratios	NDK4436
RT-52-185	J1804	All Other Ratios	NDK4437
	J1804	6.83, 7.17, 7.40 & 7.83 Ratios	NDK4438
	M1625	All Ratios	NDK4440
	M1833	All Other Ratios	NDK4441
	U1399	All Other Ratios	NDK4435
	U1399	6.83, 7.17, 7.40 & 7.83 Ratios	NDK4436
	W1791	All Other Ratios	NDK4437
	W1791	6.83, 7.17, 7.40 & 7.83 Ratios	NDK4438
	A1899	All Other Ratios	NDK4437
	A1899	6.83, 7.17, 7.40 & 7.83 Ratios	NDK4438
RT-52-380	C1381	All Other Ratios	NDK4435
	C1381	6.83, 7.17, 7.40 & 7.83 Ratios	NDK4436
	J1804	All Other Ratios	NDK4437
	J1804	6.83, 7.17, 7.40 & 7.83 Ratios	NDK4438
	M1625	All Ratios	NDK4440
	M1833	All Other Ratios	NDK4441
	U1399	All Other Ratios	NDK4435
	U1399	6.83, 7.17, 7.40 & 7.83 Ratios	NDK4436
	W1791	All Other Ratios	NDK4437
	W1791	6.83, 7.17, 7.40 & 7.83 Ratios	NDK4438
RT-58-180	All		NDK4440
	3200-M-1625		NDK4440
	M1833	All Other Ratios	NDK4441
	3200-M-1833		NDK4441
	3200-M-1625		NDK4440
	3200-M-1833		NDK4441
	3200-U-1399	6.83, 7.17 & 7.40 Ratios	NDK4436
	3200-U-1399 (All except 6.83, 7.17 & 7.40)		NDK4435
	3200-W-1791, 3200-J-1804, 3200-A-1899	6.83, 7.17 & 7.40 Ratios	NDK4438
	3200-W-1791, 3200-J-1804, 3200-A-1899 (All except 6.83, 7.17, & 7.40)		NDK4437



MERITOR KIT APPS BY AXLE			
Axle Model	Carriers	Comments	Kit
RT-58-180	A1899	All Other Ratios	NDK4437
	A1899	6.83, 7.17, 7.40 & 7.83 Ratios	NDK4438
	C1381	All Other Ratios	NDK4435
	C1381	6.83, 7.17, 7.40 & 7.83 Ratios	NDK4436
	J1804	All Other Ratios	NDK4437
	J1804	6.83, 7.17, 7.40 & 7.83 Ratios	NDK4438
	M1625	All Ratios	NDK4440
	M1833	All Other Ratios	NDK4441
	U1399	All Other Ratios	NDK4435
	U1399	6.83, 7.17, 7.40 & 7.83 Ratios	NDK4436
	W1791	All Other Ratios	NDK4437
	W1791	6.83, 7.17, 7.40 & 7.83 Ratios	NDK4438
RT-58-185	M1625	All Ratios	NDK4440
RT-58-380	3200-M-1625		NDK4440
	3200-M-1833		NDK4441
RT-70-380	M1625	All Ratios	NDK4440
	3200-M-1625		NDK4440
	M1833	All Other Ratios	NDK4441
	3200-M-1833		NDK4441
S170		W/Ford from series 732,001	NDK50A
		Prior to 12/1/83 7.40 Ratio	NDK4130
		12/1/83 & Later Exc. 7.40 Ratio	NDK4150
SL100			NDK194F
	3200R1032 3200L1078	Malleable Carrier Aluminum Carrier	NDK194F
			NDK194RB
	3200N1314 3200T1346	Malleable Carrier Aluminum Carrier	NDK194RB
SL100P			NDK194F
	3200R1032 3200L1078	Malleable Carrier Aluminum Carrier	NDK194F
			NDK194RB
	3200N1314 3200T1346	Malleable Carrier Aluminum Carrier	NDK194RB
SLHD		1-3/16" Pinion Bearing and Ratios Above 4.63	NDK9F
		From 1962 w/Ratios Above 4.63:1 & 1-3/16" I.D. Pinion Rear Bearing	NDK9F
		w/Ratios Above 4.63:1 & 1 3/16" I.D. Pinion Rear Bearing	NDK9F
		1-3/16" Pinion Bearing and Ratios Above 4.63	NDK9R
		w/Ratios Above 4.63:1 & 1- 3/16" I.D. Pinion Rear Bearing	NDK9R
		Ratios Above 4.63	NDK9RB
		w/Ratios Above 4.63:1 & 1-3/8" I.D. Pinion Rear Bearing	NDK9RB
		w/ Ratios of 4.63:1 & Below & 1-3/8" I.D. Pinions Rear Bearing	NDK9RC
		3.55-4.63 Ratios	NDK900F
		From 1962 w/Ratios Above & Below 4.63:1 & 1- 3/8" I.D. Pinion Rear Bearing	NDK900F
		w/Ratios Above & Below 4.63:1 & 1- 3/8" I.D. Pinion Rear Bearing	NDK900F
		Ratios Above 4.63	NDK900FA
	w/Ratios Above & Below 4.63:1 & 1- 3/8" I.D. Pinion Rear Bearing	NDK900FA	
SLR100			NDK194RB
SPR250		Ratios Above 4.63:1	NDK9RB
		Ratios 4.63:1 and Below	NDK9RC
		Ratios Above & Below 4.63:1	NDK900F
			NDK900FA

MERITOR KIT APPS BY AXLE			
Axle Model	Carriers	Comments	Kit
SPR270	3200-J-1076, 3200-G-1255	7.40 Ratios Only	NDK4125
	3200-M-1625	7.40 Ratios Only	NDK4145
	3200-X-1324		NDK4135
SPR400		Ratios Above 4.63:1	NDK9RB
		Ratios Below 4.63:1	NDK9RC
		Ratios Above & Below 4.63:1	NDK900F
		Ratios Above & Below 4.63:1	NDK900FA
SQ100			NDK194F
	3200R1032 3200L1078	Malleable Carrier Aluminum Carrier	NDK194F
			NDK194RB
	3200N1314 3200T1346	Malleable Carrier Aluminum Carrier	NDK194RB
SQ100P			NDK194F
			NDK194RB
	3200N1314 3200T1346	Malleable Carrier Aluminum Carrier	NDK194RB
SQDD			NDK4180
			NDK4180
SQHD		1-3/16" Pinion Bearing and Ratios Above 4.63	NDK9F
		From 1962 w/Ratios Above 4.63:1 & 1-3/16" I.D. Pinion Rear Bearing	NDK9F
		w/Ratios Above 4.63:1 & 1 3/16" I.D. Pinion Rear Bearing	NDK9F
		1-3/16" Pinion Brg and Ratios Above 4.63	NDK9R
		w/Ratios Above 4.63:1 & 1- 3/16" I.D. Pinion Rear Bearing	NDK9R
		Ratios Above 4.63	NDK9RB
		w/Ratios Above 4.63:1 & 1-3/8" I.D. Pinion Rear Bearing	NDK9RB
		w/ Ratios of 4.63:1 & Below & 1-3/8" I.D. Pinions Rear Bearing	NDK9RC
		3.55-4.63 Ratios	NDK900F
		From 1962 w/Ratios Above & Below 4.63:1 & 1- 3/8" I.D. Pinion Rear Bearing	NDK900F
		w/Ratios Above & Below 4.63:1 & 1- 3/8" I.D. Pinion Rear Bearing	NDK900F
		Ratios Above 4.63	NDK900FA
	w/Ratios Above & Below 4.63:1 & 1- 3/8" I.D. Pinion Rear Bearing	NDK900FA	
SQHP			NDK194F
			NDK194RA
	3200-Y-1039	w/2" Dia Spline Pinion Carrier	NDK194RA
		Original Design w/2" Diameter Pinion Spline	NDK194R
		Original Design	NDK194R
SQR100			NDK194F
	3200R1032 3200L1078	Malleable Carrier Aluminum Carrier	NDK194F
			NDK194RB
	3200N1314 3200T1346	Malleable Carrier Aluminum Carrier	NDK194RB
SQR100P			NDK194F
	3200R1032 3200L1078	Malleable Carrier Aluminum Carrier	NDK194F
			NDK194RB
	3200N1314 3200T1346	Malleable Carrier Aluminum Carrier	NDK194RB
SQRHD			NDK9R

MERITOR KIT APPS BY AXLE			
Axle Model	Carriers	Comments	Kit
SR170	3200-J-1076, 3200-G-1255	7.40 Ratios Only	NDK4125
	3200L1234		NDK204R
	3200-G-605, 3200-E-603	7.40 Ratios Only	NDK4130
		7.40 Ratio Only	NDK4130
	3200-M-1625	7.40 Ratios Only	NDK4145
	3200-X-1324		NDK4135
	G1255	7.40 Ratio Only	NDK4125
	M1625	All Ratios Exc. 7.40	NDK4140
	M1625	7.40 Ratio Only	NDK4145
SR270	X1234	All Ratios Exc. 7.40	NDK4135
	G1255	7.40 Ratio Only	NDK4125
	J1076	7.40 Ratio Only	NDK4125
	M1625	All Ratios Exc. 7.40	NDK4140
	M1625	7.40 Ratio Only	NDK4145
	M1625	All Ratios Exc. 7.40	NDK4155
SR280	3200-J-1076, 3200-G-1255	7.40 Ratios Only	NDK4125
	3200-M-1625	7.40 Ratios Only	NDK4145
	3200-X-1324		NDK4135
	G1255	7.40 Ratio Only	NDK4125
	J1076	7.40 Ratio Only	NDK4125
	M1625	All Ratios Exc. 7.40	NDK4140
	M1625	7.40 Ratio Only	NDK4145
	M1625	All Ratios Exc. 7.40	NDK4155
	M1625	7.40 Ratio Only	NDK4155A
SSHHD	X1324	All Ratios Exc. 7.40	NDK4135
		Ball Bearing Input & Output Shaft w/Involute Splines	NDK172FA
		Late 1972-on	NDK172FA
		Taper Bearing Input & Output Shaft	NDK172FB
		w/Involute Splines & Tapered Bearing on Output Shaft	NDK172FB
			NDK172FB
		Early Style Seal	NDK172R
			NDK172R
		Taper Bearing Input & Output Shaft w/ Upgraded o/s seal	NDK4095
		Taper Bearing Input & Ball Bearing Output Shaft	NDK4100
SSHP	3200-R-1162		NDK4100
	3200-M-1235		NDK4100
		Late Style Seal	NDK4105
		Ball Bearing Input & Output Shaft w/Involute Splines	NDK172FA
	Taper Bearing Input & Output Shaft	NDK172FB	
	Early Style Seal	NDK172R	
	Taper Bearing Input & Output Shaft w/ Upgraded o/s seal	NDK4095	

MERITOR KIT APPS BY AXLE			
Axle Model	Carriers	Comments	Kit
SSHP		Taper Bearing Input & Ball Bearing Output Shaft	NDK4100
		Late Style Seal	NDK4105
STHD		Ball Bearing Input & Output Shaft w/Involute Splines	NDK172FA
		Late 1972-on	NDK172FA
		Taper Bearing Input & Output Shaft	NDK172FB
		w/Involute Splines & Tapered Bearing on Output Shaft	NDK172FB
			NDK172FB
		Early Style Seal	NDK172R
			NDK172R
		Shaft w/Upgraded o/s seal	NDK4095
		Taper Bearing Input & Ball Bearing Output Shaft	NDK4100
		3200-R-1162	
SU170	3200-G-605, 3200-E-603	7.40 Ratios Only	NDK4130
		7.40 Ratio Only	NDK4130
	3200-J-1076, 3200-G-1255	7.40 Ratios Only	NDK4125
	3200-M-1625	7.40 Ratios Only	NDK4145
	3200-X-1324		NDK4135
	G1255	7.40 Ratio Only	NDK4125
	M1625	All Ratios Exc. 7.40	NDK4140
	M1625	7.40 Ratio Only	NDK4145
	X1234	All Ratios Exc. 7.40	NDK4135
SU270	3200-J-1076, 3200-G-1255	7.40 Ratios Only	NDK4125
	3200-M-1625	7.40 Ratios Only	NDK4145
	3200-X-1324		NDK4135
	G1255	7.40 Ratio Only	NDK4125
	J1076	7.40 Ratio Only	NDK4125
	M1625	All Ratios Exc. 7.40	NDK4140
	M1625	7.40 Ratio Only	NDK4145
	M1625	All Ratios Exc. 7.40	NDK4155
	M1625	7.40 Ratio Only	NDK4155A
	X1324	All Ratios Exc. 7.40	NDK4135
SU280	3200-J-1076, 3200-G-1255	7.40 Ratios Only	NDK4125
	3200-M-1625	7.40 Ratios Only	NDK4145
	3200-X-1324		NDK4135
	G1255	7.40 Ratio Only	NDK4125
	J1076	7.40 Ratio Only	NDK4125
	M1625	All Ratios Exc. 7.40	NDK4140
	M1625	7.40 Ratio Only	NDK4145
	M1625	All Ratios Exc. 7.40	NDK4155
	M1625	7.40 Ratio Only	NDK4155A
	X1324	All Ratios Exc. 7.40	NDK4135
SUDD		From 6-77 w/Involute Splines	NDK204R
	3200E1227		NDK204F
		From 6-77 w/Involute Splines	NDK204F

MERITOR KIT APPS BY AXLE			
Axle Model	Carriers	Comments	Kit
SUHD		Ball Bearing Input & Output Shaft w/Involute Splines	NDK172FA
		Late 1972-on	NDK172FA
		Taper Bearing Input & Output Shaft	NDK172FB
		w/Involute Splines & Tapered Bearing on Output Shaft	NDK172FB
		Late for use w/3200-R-1162 or 300-R-1162	NDK172FB
		Early Style Seal	NDK172R
			NDK172R
		Taper Bearing Input & Output Shaft w/ Upgraded o/s seal	NDK4095
		Taper Bearing Input & Ball Bearing Output Shaft	NDK4100
			NDK4100
	Late Style Seal	NDK4105	
SW170	3200-G-605, 3200-E-603	7.40 Ratios Only	NDK4130
		7.40 Ratio Only	NDK4130
	3200-J-1076, 3200-G-1255	7.40 Ratios Only	NDK4125
	3200-M-1625	7.40 Ratios Only	NDK4145
	3200-X-1324		NDK4135
	G1255	7.40 Ratio Only	NDK4125
	J1076	7.40 Ratio Only	NDK4125
	M1625	All Ratios Exc. 7.40	NDK4140
	M1625	7.40 Ratio Only	NDK4145
X1234	All Ratios Exc. 7.40	NDK4135	
SW270	3200-J-1076, 3200-G-1255	7.40 Ratios Only	NDK4125
	3200-M-1625	7.40 Ratios Only	NDK4145
	3200-X-1324		NDK4135
	G1255	7.40 Ratio Only	NDK4125
	J1076	7.40 Ratio Only	NDK4125
	M1625	All Ratios Exc. 7.40	NDK4140
	M1625	7.40 Ratio Only	NDK4145
	M1625	All Ratios Exc. 7.40	NDK4155
	M1625	7.40 Ratio Only	NDK4155A
X1324	All Ratios Exc. 7.40	NDK4135	
SW280	3200-J-1076, 3200-G-1255		NDK4125
	3200-M-1625	7.40 Ratios Only	NDK4145
	3200-X-1324		NDK4135
	G1255	7.40 Ratio Only	NDK4125
	J1076	7.40 Ratio Only	NDK4125
	M1625	All Ratios Exc. 7.40	NDK4140
	M1625	7.40 Ratio Only	NDK4145
	M1625	All Ratios Exc. 7.40	NDK4155
	M1625	7.40 Ratio Only	NDK4155A
X1324	All Ratios Exc. 7.40	NDK4135	
U140			NDK172R
		Late	NDK172R

NDK1		
Part No.	Description	Qty.
497	Bearing, Diff Right Hand Cone	1
493	Bearing, Diff Right Hand Cup	1
56425	Bearing, Diff Left Hand Cone	1
56650	Bearing, Diff Left Hand Cup	1
55200C	Bearing, Pinion Head & Pinion Tail Cone	2
55437	Bearing, Pinion Head & Pinion Tail Cup	2
WUB61307UM	Bearing, Pinion Nose CRB	1
127721	Seal, Pinion	1
TL-0.5ML	Threadlocker	1
SEALANT	RTV Silicone	1

NDK1-V100		
Part No.	Description	Qty.
497	Bearing, Diff Right Hand Cone	1
493	Bearing, Diff Right Hand Cup	1
56425	Bearing, Diff Left Hand Cone	1
56650	Bearing, Diff Left Hand Cup	1
55200C	Bearing, Pinion Head & Pinion Tail Cone	2
55437	Bearing, Pinion Head & Pinion Tail Cup	2
WUB61307UM	Bearing, Pinion Nose CRB	1
127721	Seal, Pinion	1

NDK1A		
Part No.	Description	Qty.
497	Bearing, Diff Right Hand Cone	1
493	Bearing, Diff Right Hand Cup	1
567	Bearing, Diff Left Hand Cone	1
563	Bearing, Diff Left Hand Cup	1
55200C	Bearing, Pinion Head Cone	1
55437	Bearing, Pinion Head Cup	1
55200C	Bearing, Pinion Tail Cone	1
55437	Bearing, Pinion Tail Cup	1
MUB1307UBM	Bearing, Pinion Nose	1
127721-NTN	Seal Pinion	1
SEALANT	RTV Silicone	1

NDK1A-V100		
Part No.	Description	Qty.
497	Bearing, Diff Right Hand Cone	1
493	Bearing, Diff Right Hand Cup	1
567	Bearing, Diff Left Hand Cone	1
563	Bearing, Diff Left Hand Cup	1
55200C	Bearing, Pinion Head Cone	1
55437	Bearing, Pinion Head Cup	1
55200C	Bearing, Pinion Tail Cone	1
55437	Bearing, Pinion Tail Cup	1
MUB1307UBM	Bearing, Pinion Nose	1
127721-NTN	Seal Pinion	1

NDK9F		
Part No.	Description	Qty.
496	Bearing, Diff Right & Left Hand Cone	2
493	Bearing, Diff Right & Left Hand Cup	2
72200C	Bearing, Pinion Head & Tail Cone	2
72487	Bearing, Pinion Head & Tail Cup	2
MUF1306TDM	Bearing, Pinion Nose CRB	2
29675	Bearing, Drive Gear Front & Rear Cone	2
29630	Bearing, Drive Gear Front & Rear Cup	2
31597	Bearing, Idler Gear Cone	2
31520	Bearing, Idler Gear Cup	2
6211	Bearing, Input Shaft DGGB	2
SLS-1707	Seal, Pinion Shaft	1
SLS-1808	Seal, Thrushaft	1
TL-0.5ML	Threadlocker	1
SEALANT	RTV Silicone	1

NDK9F-V100		
Part No.	Description	Qty.
496	Bearing, Diff Right & Left Hand Cone	2
493	Bearing, Diff Right & Left Hand Cup	2
72200C	Bearing, Pinion Head & Tail Cone	2
72487	Bearing, Pinion Head & Tail Cup	2
MUF1306TDM	Bearing, Pinion Nose CRB	2
29675	Bearing, Drive Gear Front & Rear Cone	2
29630	Bearing, Drive Gear Front & Rear Cup	2
31597	Bearing, Idler Gear Cone	2
31520	Bearing, Idler Gear Cup	2
6211	Bearing, Input Shaft DGGB	2
SLS-1707	Seal, Pinion Shaft	1
SLS-1808	Seal, Thrushaft	1

NDK9R		
Part No.	Description	Qty.
496	Bearing, Diff Right & Left Hand Cone	2
493	Bearing, Diff Right & Left Hand Cup	2
72200C	Bearing, Pinion Head Cone	1
72188C	Bearing, Pinion Tail Cone	1
72487	Bearing, Pinion Head & Tail Cup	2
MUF1306TDM	Bearing, Pinion Nose CRB	1
SLS-1787	Seal, Pinion Shaft	1
TL-0.5ML	Threadlocker	1
SEALANT	RTV Silicone	1

NDK9R-V100		
Part No.	Description	Qty.
496	Bearing, Diff Right & Left Hand Cone	2
493	Bearing, Diff Right & Left Hand Cup	2
72200C	Bearing, Pinion Head Cone	1
72188C	Bearing, Pinion Tail Cone	1
72487	Bearing, Pinion Head & Tail Cup	2
MUF1306TDM	Bearing, Pinion Nose CRB	1
SLS-1787	Seal, Pinion Shaft	1

NDK9RB		
Part No.	Description	Qty.
496	Bearing, Diff Right & Left Hand Cone	2
493	Bearing, Diff Right & Left Hand Cup	2
72200C	Bearing, Pinion Head Cone	1
72188C	Bearing, Pinion Tail Cone	1
72487	Bearing, Pinion Head & Pinion Tail Cup	2
RU1570UM	Bearing, Pinion Nose CRB	1
27452	Seal, Pinion	1
TL-0.5ML	Threadlocker	1
SEALANT	RTV Silicone	1

NDK9RB-V100		
Part No.	Description	Qty.
496	Bearing, Diff Right & Left Hand Cone	2
493	Bearing, Diff Right & Left Hand Cup	2
72200C	Bearing, Pinion Head Cone	1
72188C	Bearing, Pinion Tail Cone	1
72487	Bearing, Pinion Head & Pinion Tail Cup	2
RU1570UM	Bearing, Pinion Nose CRB	1
27452	Seal, Pinion	1

NDK9RC		
Part No.	Description	Qty.
496	Bearing, Diff Right Hand Cone	1
497	Bearing, Diff Left Hand Cone	1
493	Bearing, Differential Right & Left Hand Cup	2
72200C	Bearing, Pinion Head Cone	1
72188C	Bearing, Pinion Tail Cone	1
72487	Bearing, Pinion Head & Tail Cup	2
RU1570UM	Bearing, Pinion Nose CRB	1
SLS-1787	Seal, Pinion	1
TL-0.5ML	Threadlocker	1
SEALANT	RTV Silicone	1

NDK9RC-V100		
Part No.	Description	Qty.
496	Bearing, Diff Right Hand Cone	1
497	Bearing, Diff Left Hand Cone	1
493	Bearing, Differential Right & Left Hand Cup	2
72200C	Bearing, Pinion Head Cone	1
72188C	Bearing, Pinion Tail Cone	1
72487	Bearing, Pinion Head & Tail Cup	2
RU1570UM	Bearing, Pinion Nose CRB	1
SLS-1787	Seal, Pinion	1

NDK18D		
Part No.	Description	Qty.
42381	Bearing, Diff Right Cone	1
42584	Bearing, Diff Right Cup	1
665	Bearing, Diff Left Cone	1
653	Bearing, Diff Left Cup	1
78215C	Bearing, Pinion Head Cone	1
78551	Bearing, Pinion Head Cup	1
72212C	Bearing, Pinion Tail Cone	1
72487	Bearing, Pinion Tail Cup	1
MU1309UM	Bearing, Pinion Nose CRB	1
SLS-1746	Seal, Pinion	1
TL-0.5ML	Threadlocker	1
SEALANT	RTV Silicone	1

NDK18D-V100		
Part No.	Description	Qty.
42381	Bearing, Diff Right Cone	1
42584	Bearing, Diff Right Cup	1
665	Bearing, Diff Left Cone	1
653	Bearing, Diff Left Cup	1
78215C	Bearing, Pinion Head Cone	1
78551	Bearing, Pinion Head Cup	1
72212C	Bearing, Pinion Tail Cone	1
72487	Bearing, Pinion Tail Cup	1
MU1309UM	Bearing, Pinion Nose CRB	1
SLS-1746	Seal, Pinion	1

NDK18E		
Part No.	Description	Qty.
42381	Bearing, Diff Right Cone	1
42584	Bearing, Diff Right Cup	1
665	Bearing, Diff Left Cone	1
653	Bearing, Diff Left Cup	1
78215C*	Bearing, Pinion Head Cone	1
78551*	Bearing, Pinion Head Cup	1
72212C	Bearing, Pinion Tail Cone	1
72487	Bearing, Pinion Tail Cup	1
WUS61308UM	Bearing, Pinion Nose CRB	1
SLS-1746	Seal, Pinion	1
TL-0.5ML	Threadlocker	1
SEALANT	RTV Silicone	1

\*FOR GMC (1984 & LATER) END USER WILL NEED TO PURCHASE 72212CPW3VW2/72487PE2VW7 IN PLACE OF 78215C/78551

NDK18E-V100		
Part No.	Description	Qty.
42381	Bearing, Diff Right Cone	1
42584	Bearing, Diff Right Cup	1
665	Bearing, Diff Left Cone	1
653	Bearing, Diff Left Cup	1
78215C*	Bearing, Pinion Head Cone	1
78551*	Bearing, Pinion Head Cup	1
72212C	Bearing, Pinion Tail Cone	1
72487	Bearing, Pinion Tail Cup	1
WUS61308UM	Bearing, Pinion Nose CRB	1
SLS-1746	Seal, Pinion	1

\*FOR GMC (1984 & LATER) END USER WILL NEED TO PURCHASE 72212CPW3VW2/72487PE2VW7 IN PLACE OF 78215C/78551

NDK23		
Part No.	Description	Qty.
495A	Bearing, Diff Right Hand Cone	1
493	Bearing, Diff Right Hand Cup	1
42381	Bearing, Diff Left Hand Cone	1
42584	Bearing, Diff Left Hand Cup	1
HM903249	Bearing, Pinion Head & Pinion Tail Cone	2
HM903210	Bearing, Pinion Head & Pinion Tail Cup	2
WUB61307UM	Bearing, Pinion Nose CRB	1
712375	Seal, Pinion (2.375" Shaft)	1
712625	Seal, Pinion (2.625" Shaft)	1
TL-0.5ML	Threadlocker	1
SEALANT	RTV Silicone	1

NDK23-V100		
Part No.	Description	Qty.
495A	Bearing, Diff Right Hand Cone	1
493	Bearing, Diff Right Hand Cup	1
42381	Bearing, Diff Left Hand Cone	1
42584	Bearing, Diff Left Hand Cup	1
HM903249	Bearing, Pinion Head & Pinion Tail Cone	2
HM903210	Bearing, Pinion Head & Pinion Tail Cup	2
WUB61307UM	Bearing, Pinion Nose CRB	1
712375	Seal, Pinion (2.375" Shaft)	1
712625	Seal, Pinion (2.625" Shaft)	1

NDK23B		
Part No.	Description	Qty.
3994	Bearing, Diff Right Cone	1
3920	Bearing, Diff Right Cup	1
567	Bearing, Diff Left Cone	1
563	Bearing, Diff Left Cup	1
HM903249	Bearing, Pinion Head & Pinion Tail Cone	2
HM903210	Bearing, Pinion Head & Pinion Tail Cup	2
WUB61307UM	Bearing, Pinion Nose CRB	1
SLS-1768	Seal, Pinion (2-3/8" Shaft)	1
SLS-1769	Seal, Pinion (2-5/8" Shaft)	1
TL-0.5ML	Threadlocker	1
SEALANT	RTV Silicone	1

NDK23B-V100		
Part No.	Description	Qty.
3994	Bearing, Diff Right Cone	1
3920	Bearing, Diff Right Cup	1
567	Bearing, Diff Left Cone	1
563	Bearing, Diff Left Cup	1
HM903249	Bearing, Pinion Head & Pinion Tail Cone	2
HM903210	Bearing, Pinion Head & Pinion Tail Cup	2
WUB61307UM	Bearing, Pinion Nose CRB	1
SLS-1768	Seal, Pinion (2-3/8" Shaft)	1
SLS-1769	Seal, Pinion (2-5/8" Shaft)	1

NDK23D		
Part No.	Description	Qty.
495A	Bearing, Diff Right Hand Cone	1
493	Bearing, Diff Right Hand Cup	1
42381	Bearing, Diff Left Hand Cone	1
42584	Bearing, Diff Left Hand Cup	1
55175C	Bearing, Pinion Head & Pinion Tail Cone	2
55437	Bearing, Pinion Head & Pinion Tail Cup	2
MUB1307UBM	Bearing, Pinion Nose CRB	1
23770	Seal, Pinion (2.375" Shaft)	1
26373	Seal, Pinion (2.625" Shaft)	1
TL-0.5ML	Threadlocker	1
SEALANT	RTV Silicone	1

NDK23D-V100		
Part No.	Description	Qty.
495A	Bearing, Diff Right Hand Cone	1
493	Bearing, Diff Right Hand Cup	1
42381	Bearing, Diff Left Hand Cone	1
42584	Bearing, Diff Left Hand Cup	1
55175C	Bearing, Pinion Head & Pinion Tail Cone	2
55437	Bearing, Pinion Head & Pinion Tail Cup	2
MUB1307UBM	Bearing, Pinion Nose CRB	1
23770	Seal, Pinion (2.375" Shaft)	1
26373	Seal, Pinion (2.625" Shaft)	1

NDK24		
Part No.	Description	Qty.
33275	Bearing, Diff Right Hand Cone	1
33472	Bearing, Diff Right Hand Cup	1
498*	Bearing, Diff Left Hand Cone	1
493*	Bearing, Diff Left Hand Cup	1
HM903249	Bearing, Pinion Head & Pinion Tail Cone	2
HM903210	Bearing, Pinion Head & Pinion Tail Cup	2
MUB1307TDM	Bearing, Pinion Nose CRB	1
22425	Seal, Pinion (2.250" x 3.194")	1
22653	Seal, Pinion (2.250" x 4.069")	1
712625	Seal, Pinion (2.625" x 4.069")	1
TL-0.5ML	Threadlocker	1
SEALANT	RTV Silicone	1

NDK24-V100		
Part No.	Description	Qty.
33275	Bearing, Diff Right Hand Cone	1
33472	Bearing, Diff Right Hand Cup	1
498*	Bearing, Diff Left Hand Cone	1
493*	Bearing, Diff Left Hand Cup	1
HM903249	Bearing, Pinion Head & Pinion Tail Cone	2
HM903210	Bearing, Pinion Head & Pinion Tail Cup	2
MUB1307TDM	Bearing, Pinion Nose CRB	1
22425	Seal, Pinion (2.250" x 3.194")	1
22653	Seal, Pinion (2.250" x 4.069")	1
712625	Seal, Pinion (2.625" x 4.069")	1

\*FOR GMC (1986-1987), END USER WILL NEED TO PURCHASE 3994/3920 TO USE IN PLACE OF 498/493

\*FOR GMC (1986-1987), END USER WILL NEED TO PURCHASE 3994/3920 TO USE IN PLACE OF 498/493

NDK50		
Part No.	Description	Qty.
598	Bearing, Diff Right Hand Cone	1
592A	Bearing, Diff Right Hand Cup	1
52387	Bearing, Diff Left Hand Cone	1
52618	Bearing, Diff Left Hand Cup	1
H715343	Bearing, Pinion Head Cone	1
H715334	Bearing, Pinion Tail Cone	1
H715311	Bearing, Pinion Head & Pinion Tail Cup	2
MUB1309TM	Bearing, Pinion Nose CRB	1
SLS-1788	Seal, Pinion	1
TL-0.5ML	Threadlocker	1
SEALANT	RTV Silicone	1

NDK50-V100		
Part No.	Description	Qty.
598	Bearing, Diff Right Hand Cone	1
592A	Bearing, Diff Right Hand Cup	1
52387	Bearing, Diff Left Hand Cone	1
52618	Bearing, Diff Left Hand Cup	1
H715343	Bearing, Pinion Head Cone	1
H715334	Bearing, Pinion Tail Cone	1
H715311	Bearing, Pinion Head & Pinion Tail Cup	2
MUB1309TM	Bearing, Pinion Nose CRB	1
SLS-1788	Seal, Pinion	1

NDK50A		
Part No.	Description	Qty.
598	Bearing, Diff Right Cone	1
592A	Bearing, Diff Right Cup	1
52387	Bearing, Diff Left Cone	1
52618	Bearing, Diff Left Cup	1
H715343	Bearing, Pinion Head Cone	1
H715311	Bearing, Pinion Head Cup	1
HM813843	Bearing, Pinion Tail Cone	1
HM813810	Bearing, Pinion Tail Cup	1
MUB1309UM	Bearing, Pinion Nose CRB	1
SLS-1788	Seal, Pinion	1
TL-0.5ML	Threadlocker	1
SEALANT	RTV Silicone	1

NDK50A-V100		
Part No.	Description	Qty.
JM716649	Bearing, Diff Right Cone	1
JM716610	Bearing, Diff Right Cup	1
JP12049	Bearing, Diff Left Cone	1
JP12010	Bearing, Diff Left Cup	1
78225C	Bearing, Pinion Head Cone	1
78551	Bearing, Pinion Head Cup	1
55206C	Bearing, Pinion Tail Cone	1
55437	Bearing, Pinion Tail Cup	1
MUB1307UBM	Bearing, Pinion Nose CRB	1
SLS-1711	Seal, Pinion	1

NDK64F		
Part No.	Description	Qty.
56425	Bearing, Diff Right Hand Cone	1
56650	Bearing, Diff Right Hand Cup	1
497	Bearing, Diff Left Hand Cone	1
493	Bearing, Diff Left Hand Cup	1
72200C	Bearing, Pinion Head & Pinion Tail Cone	2
72487	Bearing, Pinion Head & Pinion Tail Cup	2
MUB1307UBM	Bearing, Pinion Nose CRB	1
1311L0	Bearing, Input Shaft Front DGGB	1
34274	Bearing, Output Shaft Front Cone	1
34429A	Bearing, Output Shaft Front Cup	1
MA1209EL	Bearing, Output Shaft Rear CRB	1
127720	Seal, Input & Thrushaft	2
TL-0.5ML	Threadlocker	1
SEALANT	RTV Silicone	1

NDK64F-V100		
Part No.	Description	Qty.
56425	Bearing, Diff Right Hand Cone	1
56650	Bearing, Diff Right Hand Cup	1
497	Bearing, Diff Left Hand Cone	1
493	Bearing, Diff Left Hand Cup	1
72200C	Bearing, Pinion Head & Pinion Tail Cone	2
72487	Bearing, Pinion Head & Pinion Tail Cup	2
MUB1307UBM	Bearing, Pinion Nose CRB	1
1311L0	Bearing, Input Shaft Front DGGB	1
34274	Bearing, Output Shaft Front Cone	1
34429A	Bearing, Output Shaft Front Cup	1
MA1209EL	Bearing, Output Shaft Rear CRB	1
127720	Seal, Input & Thrushaft	2

NDK64FC		
Part No.	Description	Qty.
567	Bearing, Diff Right Hand Cone	1
563	Bearing, Diff Right Hand Cup	1
497	Bearing, Diff Left Hand Cone	1
493	Bearing, Diff Left Hand Cup	1
72200C	Bearing, Pinion Head & Tail Cone	2
72487	Bearing, Pinion Head & Tail Cup	2
MUSB61307UM	Bearing, Pinion Nose CRB	1
1311L	Bearing, Input Shaft Front DGGB	1
34274	Bearing, Output Shaft Front Cone	1
34492A	Bearing, Output Shaft Front Cup	1
MA1209TV (Inner Ring)*	Bearing, Output Shaft Rear, CRB	1
MA1207TV (Outer Ring)*	Bearing, Output Shaft Rear, CRB	1
SLS-1694	Seal, Input Shaft	1
SLS-1694	Seal, Thrushaft	1
TL-0.5ML	Threadlocker	1
SEALANT	RTV Silicone	1

NDK64FC-V100		
Part No.	Description	Qty.
567	Bearing, Diff Right Hand Cone	1
563	Bearing, Diff Right Hand Cup	1
497	Bearing, Diff Left Hand Cone	1
493	Bearing, Diff Left Hand Cup	1
72200C	Bearing, Pinion Head & Tail Cone	2
72487	Bearing, Pinion Head & Tail Cup	2
MUSB61307UM	Bearing, Pinion Nose CRB	1
1311L	Bearing, Input Shaft Front DGGB	1
34274	Bearing, Output Shaft Front Cone	1
34492A	Bearing, Output Shaft Front Cup	1
MA1209TV (Inner Ring)*	Bearing, Output Shaft Rear, CRB	1
MA1207TV (Outer Ring)*	Bearing, Output Shaft Rear, CRB	1
SLS-1694	Seal, Input Shaft	1
SLS-1694	Seal, Thrushaft	1

\*USE INNER RING & OUTER RING MA1209TV

\*USE INNER RING & OUTER RING MA1209TV



NDK64FD		
Part No.	Description	Qty.
567	Bearing, Diff Right Cone	1
563	Bearing, Diff Right Cup	1
497	Bearing, Diff Left Cone	1
493	Bearing, Diff Left Cup	1
72200C	Bearing, Pinion Head & Pinion Tail Cone	2
72487	Bearing, Pinion Head & Pinion Tail Cup	2
WUB61307UM	Bearing, Pinion Nose CRB	1
JM207049	Bearing, Input Shaft Front Cone	1
JM207010	Bearing, Input Shaft Front Cup	1
34274	Bearing, Output Shaft Front Cone	1
34492A	Bearing, Output Shaft Front Cup	1
MA1209TV (Inner Ring)*	Bearing, Output Shaft Rear CRB-IR	1
MA1209TV (Outer Ring)*	Bearing, Output Shaft Rear CRB-OR	1
SLS-1694	Seal, Input Shaft & Thrushaft	2
TL-0.5ML	Threadlocker	1
SEALANT	RTV Silicone	1

NDK64FD-V100		
Part No.	Description	Qty.
567	Bearing, Diff Right Cone	1
563	Bearing, Diff Right Cup	1
497	Bearing, Diff Left Cone	1
493	Bearing, Diff Left Cup	1
72200C	Bearing, Pinion Head & Pinion Tail Cone	2
72487	Bearing, Pinion Head & Pinion Tail Cup	2
WUB61307UM	Bearing, Pinion Nose CRB	1
JM207049	Bearing, Input Shaft Front Cone	1
JM207010	Bearing, Input Shaft Front Cup	1
34274	Bearing, Output Shaft Front Cone	1
34492A	Bearing, Output Shaft Front Cup	1
MA1209TV (Inner Ring)*	Bearing, Output Shaft Rear CRB-IR	1
MA1209TV (Outer Ring)*	Bearing, Output Shaft Rear CRB-OR	1
SLS-1694	Seal, Input Shaft & Thrushaft	2

NDK64FE		
Part No.	Description	Qty.
56425	Bearing, Diff Right Hand Cone	1
56650	Bearing, Diff Right Hand Cup	1
497	Bearing, Diff Left Hand Cone	1
493	Bearing, Diff Left Hand Cup	1
72200C	Bearing, Pinion Head & Pinion Tail Cone	2
72487	Bearing, Pinion Head & Pinion Tail Cup	2
MUB1307UBM	Bearing, Pinion Nose CRB	1
JM207049	Bearing, Input Shaft Front Cone	1
JM207010	Bearing, Input Shaft Front Cup	1
34274	Bearing, Output Shaft Front Cone	1
34492A	Bearing, Output Shaft Front Cup	1
MA1209EL	Bearing, Output Shaft Rear CRB	1
127720	Seal, Input & Thrushaft	2
TL-0.5ML	Threadlocker	1
SEALANT	RTV Silicone	1

NDK64FE-V100		
Part No.	Description	Qty.
56425	Bearing, Diff Right Hand Cone	1
56650	Bearing, Diff Right Hand Cup	1
497	Bearing, Diff Left Hand Cone	1
493	Bearing, Diff Left Hand Cup	1
72200C	Bearing, Pinion Head & Pinion Tail Cone	2
72487	Bearing, Pinion Head & Pinion Tail Cup	2
MUB1307UBM	Bearing, Pinion Nose CRB	1
JM207049	Bearing, Input Shaft Front Cone	1
JM207010	Bearing, Input Shaft Front Cup	1
34274	Bearing, Output Shaft Front Cone	1
34492A	Bearing, Output Shaft Front Cup	1
MA1209EL	Bearing, Output Shaft Rear CRB	1
127720	Seal, Input & Thrushaft	2

NDK72		
Part No.	Description	Qty.
42346	Bearing, Diff Right Hand Cone	1
42584	Bearing, Diff Right Hand Cup	1
68450	Bearing, Diff Left Hand Cone	1
68712	Bearing, Diff Left Hand Cup	1
72212C	Bearing, Pinion Head & Tail Cone	2
72487	Bearing, Pinion Head & Tail Cup	2
WUS61308UM	Bearing, Pinion Nose, CRB	1
SLS-1785	Seal, Pinion	1
TL-0.5ML	Threadlocker	1
SEALANT	RTV Silicone	1

NDK72-V100		
Part No.	Description	Qty.
42346	Bearing, Diff Right Hand Cone	1
42584	Bearing, Diff Right Hand Cup	1
68450	Bearing, Diff Left Hand Cone	1
68712	Bearing, Diff Left Hand Cup	1
72212C	Bearing, Pinion Head & Tail Cone	2
72487	Bearing, Pinion Head & Tail Cup	2
WUS61308UM	Bearing, Pinion Nose, CRB	1
SLS-1785	Seal, Pinion	1

NDK72A		
Part No.	Description	Qty.
42346	Bearing, Diff Right Hand Cone	1
42584	Bearing, Diff Right Hand Cup	1
68450	Bearing, Diff Left Hand Cone	1
68712	Bearing, Diff Left Hand Cup	1
78215C	Bearing, Pinion Head Cone	1
78551	Bearing, Pinion Head Cup	1
72212C	Bearing, Pinion Tail Cone	1
72487	Bearing, Pinion Tail Cup	1
WUS61308UM	Bearing, Pinion Nose, CRB	1
119432	Seal, Pinion	1
TL-0.5ML	Threadlocker	1
SEALANT	RTV Silicone	1

NDK72A-V100		
Part No.	Description	Qty.
42346	Bearing, Diff Right Hand Cone	1
42584	Bearing, Diff Right Hand Cup	1
68450	Bearing, Diff Left Hand Cone	1
68712	Bearing, Diff Left Hand Cup	1
78215C	Bearing, Pinion Head Cone	1
78551	Bearing, Pinion Head Cup	1
72212C	Bearing, Pinion Tail Cone	1
72487	Bearing, Pinion Tail Cup	1
WUS61308UM	Bearing, Pinion Nose, CRB	1
119432	Seal, Pinion	1

NDK72B		
Part No.	Description	Qty.
42346	Bearing, Diff Right Hand Cone	1
42584	Bearing, Diff Right Hand Cup	1
68462	Bearing, Diff Left Hand Cone	1
68712	Bearing, Diff Left Hand Cup	1
78215C	Bearing, Pinion Head Cone	1
78551	Bearing, Pinion Head Cup	1
72212C	Bearing, Pinion Tail Cone	1
72487	Bearing, Pinion Tail Cup	1
WUS61308UM	Bearing, Pinion Nose, CRB	1
119432	Seal, Pinion	1
TL-0.5ML	Threadlocker	1
SEALANT	RTV Silicone	1

NDK72B-V100		
Part No.	Description	Qty.
42346	Bearing, Diff Right Hand Cone	1
42584	Bearing, Diff Right Hand Cup	1
68462	Bearing, Diff Left Hand Cone	1
68712	Bearing, Diff Left Hand Cup	1
78215C	Bearing, Pinion Head Cone	1
78551	Bearing, Pinion Head Cup	1
72212C	Bearing, Pinion Tail Cone	1
72487	Bearing, Pinion Tail Cup	1
WUS61308UM	Bearing, Pinion Nose, CRB	1
119432	Seal, Pinion	1

NDK117		
Part No.	Description	Qty.
598A	Bearing, Diff Right & Left Hand Cone	2
592A	Bearing, Diff Right & Left Hand Cup	2
H715340	Bearing, Pinion Head Cone	1
H715310	Bearing, Pinion Head Cup	1
65212	Bearing, Pinion Tail Cone	1
65500	Bearing, Pinion Tail Cup	1
6379	Bearing, Cross Shaft Right & Left Hand Cone	2
6320	Bearing, Cross Shaft Right & Left Hand Cup	2
415009	Seal, Pinion	1
27601	Seal, Pinion (2-speed)	1
OR250	O-Ring	1
OR262	O-Ring	1
TL-0.5ML	Threadlocker	1
SEALANT	RTV Silicone	1

NDK117-V100		
Part No.	Description	Qty.
598A	Bearing, Diff Right & Left Hand Cone	2
592A	Bearing, Diff Right & Left Hand Cup	2
H715340	Bearing, Pinion Head Cone	1
H715310	Bearing, Pinion Head Cup	1
65212	Bearing, Pinion Tail Cone	1
65500	Bearing, Pinion Tail Cup	1
6379	Bearing, Cross Shaft Right & Left Hand Cone	2
6320	Bearing, Cross Shaft Right & Left Hand Cup	2
415009	Seal, Pinion	1
27601	Seal, Pinion (2-speed)	1
OR250	O-Ring	1
OR262	O-Ring	1

NDK117A		
Part No.	Description	Qty.
598A	Bearing, Diff Right & Left Hand Cone	2
592A	Bearing, Diff Right & Left Hand Cup	2
H715340	Bearing, Pinion Head Cone	1
H715310	Bearing, Pinion Head Cup	1
65212	Bearing, Pinion Tail Cone	1
65500	Bearing, Pinion Tail Cup	1
6379	Bearing, Cross Shaft Right & Left Hand Cone	2
6320	Bearing, Cross Shaft Right & Left Hand Cup	2
415009	Seal, Pinion	1
OR250	O-Ring	1
OR262	O-Ring	1
TL-0.5ML	Threadlocker	1
SEALANT	RTV Silicone	1

NDK117A-V100		
Part No.	Description	Qty.
598A	Bearing, Diff Right & Left Hand Cone	2
592A	Bearing, Diff Right & Left Hand Cup	2
H715340	Bearing, Pinion Head Cone	1
H715310	Bearing, Pinion Head Cup	1
65212	Bearing, Pinion Tail Cone	1
65500	Bearing, Pinion Tail Cup	1
6379	Bearing, Cross Shaft Right & Left Hand Cone	2
6320	Bearing, Cross Shaft Right & Left Hand Cup	2
415009	Seal, Pinion	1
OR250	O-Ring	1
OR262	O-Ring	1

NDK172F		
Part No.	Description	Qty.
47890	Bearing, Diff Right & Left Hand Cone	2
47820	Bearing, Diff Right & Left Hand Cup	2
H715343	Bearing, Pinion Head Cone	1
H715311	Bearing, Pinion Head Cup	1
65237	Bearing, Pinion Tail Cone	1
65500	Bearing, Pinion Tail Cup	1
MU1015DCV	Bearing, Drive Gear Front CRB	1
6313	Bearing, Input Shaft DGGB	1
6210	Bearing, Thrushaft DGGB	1
SLS-1808	Seal, Input Shaft	1
SLS-1788	Seal, Thrushaft	1
TL-0.5ML	Threadlocker	1
SEALANT	RTV Silicone	1

NDK172F-V100		
Part No.	Description	Qty.
47890	Bearing, Diff Right & Left Hand Cone	2
47820	Bearing, Diff Right & Left Hand Cup	2
H715343	Bearing, Pinion Head Cone	1
H715311	Bearing, Pinion Head Cup	1
65237	Bearing, Pinion Tail Cone	1
65500	Bearing, Pinion Tail Cup	1
MU1015DCV	Bearing, Drive Gear Front CRB	1
6313	Bearing, Input Shaft DGGB	1
6210	Bearing, Thrushaft DGGB	1
SLS-1808	Seal, Input Shaft	1
SLS-1788	Seal, Thrushaft	1

NDK172FA		
Part No.	Description	Qty.
47890	Bearing, Diff Right & Left Cone	2
47820	Bearing, Diff Right & Left Cup	2
H715343	Bearing, Pinion Head Cone	1
H715311	Bearing, Pinion Head Cup	1
65237	Bearing, Pinion Tail Cone	1
65500	Bearing, Pinion Tail Cup	1
MU1015DCV	Bearing, Drive Gear Front CRB	1
6313	Bearing, Input Shaft DGGB	1
6210	Bearing, Thrushaft DGGB	1
SLS-1788	Seal, Input	1
SLS-1808	Seal, Thrushaft	1
TL-0.5ML	Threadlocker	1
SEALANT	RTV Silicone	1

NDK172FA-V100		
Part No.	Description	Qty.
47890	Bearing, Diff Right & Left Cone	2
47820	Bearing, Diff Right & Left Cup	2
H715343	Bearing, Pinion Head Cone	1
H715311	Bearing, Pinion Head Cup	1
65237	Bearing, Pinion Tail Cone	1
65500	Bearing, Pinion Tail Cup	1
MU1015DCV	Bearing, Drive Gear Front CRB	1
6313	Bearing, Input Shaft DGGB	1
6210	Bearing, Thrushaft DGGB	1
SLS-1788	Seal, Input	1
SLS-1808	Seal, Thrushaft	1

NDK172FB		
Part No.	Description	Qty.
47890	Bearing, Diff Right & Left Cone	2
47820	Bearing, Diff Right & Left Cup	2
H715343	Bearing, Pinion Head Cone	1
H715311	Bearing, Pinion Head Cup	1
65237	Bearing, Pinion Tail Cone	1
65500	Bearing, Pinion Tail Cup	1
JLM714149	Bearing, Inter Diff Cone	1
JLM714110	Bearing, Inter Diff Cup	1
JH211749	Bearing, Input Shaft Cone	1
JH211710	Bearing, Input Shaft Cup	1
LM104949	Bearing, Thrushaft Cone	2
JLM104910	Bearing, Thrushaft Cup	2
SLS-1950	Seal, Input	1
SLS-1808	Seal, Thrushaft	1
TL-0.5ML	Threadlocker	1
SEALANT	RTV Silicone	1

NDK172FB-V100		
Part No.	Description	Qty.
47890	Bearing, Diff Right & Left Cone	2
47820	Bearing, Diff Right & Left Cup	2
H715343	Bearing, Pinion Head Cone	1
H715311	Bearing, Pinion Head Cup	1
65237	Bearing, Pinion Tail Cone	1
65500	Bearing, Pinion Tail Cup	1
JLM714149	Bearing, Inter Diff Cone	1
JLM714110	Bearing, Inter Diff Cup	1
JH211749	Bearing, Input Shaft Cone	1
JH211710	Bearing, Input Shaft Cup	1
LM104949	Bearing, Thrushaft Cone	2
JLM104910	Bearing, Thrushaft Cup	2
SLS-1950	Seal, Input	1
SLS-1808	Seal, Thrushaft	1

NDK172R		
Part No.	Description	Qty.
47890	Bearing, Diff Right & Left Cone	2
47820	Bearing, Diff Right & Left Cup	2
H715343	Bearing, Pinion Head Cone	1
H715311	Bearing, Pinion Tail Cone	1
H715334	Bearing, Pinion Head & Tail Cup	2
MU1308UM	Bearing, Pinion Nose CRB	1
SLS-1777*	Seal, Pinion	1
SLS-1885*	Seal, Pinion	1
TL-0.5ML	Threadlocker	1
SEALANT	RTV Silicone	1

NDK172R-V100		
Part No.	Description	Qty.
47890	Bearing, Diff Right & Left Cone	2
47820	Bearing, Diff Right & Left Cup	2
H715343	Bearing, Pinion Head Cone	1
H715311	Bearing, Pinion Tail Cone	1
H715334	Bearing, Pinion Head & Tail Cup	2
MU1308UM	Bearing, Pinion Nose CRB	1
SLS-1777*	Seal, Pinion	1
SLS-1885*	Seal, Pinion	1

\*USE SLS-1885 FOR AXLE PART NUMBERS SSSH, STHD AND SUHD. USE SLS-1777 FOR ALL OTHER AXLE APPLICATIONS

\*USE SLS-1885 FOR AXLE PART NUMBERS SSSH, STHD AND SUHD. USE SLS-1777 FOR ALL OTHER AXLE APPLICATIONS

NDK191F		
Part No.	Description	Qty.
3984	Bearing, Diff Right & Left Hand Cone	2
3925	Bearing, Diff Right & Left Hand Cup	2
55175C	Bearing, Pinion Head & Tail Cone	2
55437	Bearing, Pinion Head & Tail Cup	2
MUB5206UM	Bearing, Pinion Nose CRB	1
25877	Bearing, Idler Gear Cone	2
25821	Bearing, Idler Gear Cup	2
6022NR	Bearing, Input Shaft DGBB	1
6210	Bearing, Output Shaft DGBB	1
6213ZNR	Bearing, Drive Gear DGBB	1
6310	Bearing, Input Shaft DGBB	1
WSH-1884	Washer, Thrust Bearing Race	1
WSH-1886	Washer, Thrust Bearing Race	2
SLS-1716	Seal, Input Shaft	1
SLS-1879	Seal, Thrushaft	1
TL-0.5ML	Threadlocker	1
SEALANT	RTV Silicone	1

NDK191F-V100		
Part No.	Description	Qty.
3984	Bearing, Diff Right & Left Hand Cone	2
3925	Bearing, Diff Right & Left Hand Cup	2
55175C	Bearing, Pinion Head & Tail Cone	2
55437	Bearing, Pinion Head & Tail Cup	2
MUB5206UM	Bearing, Pinion Nose CRB	1
25877	Bearing, Idler Gear Cone	2
25821	Bearing, Idler Gear Cup	2
6022NR	Bearing, Input Shaft DGBB	1
6210	Bearing, Output Shaft DGBB	1
6213ZNR	Bearing, Drive Gear DGBB	1
6310	Bearing, Input Shaft DGBB	1
WSH-1884	Washer, Thrust Bearing Race	1
WSH-1886	Washer, Thrust Bearing Race	2
SLS-1716	Seal, Input Shaft	1
SLS-1879	Seal, Thrushaft	1

NDK191R		
Part No.	Description	Qty.
3984	Bearing, Diff Right & Left Hand Cone	2
3920	Bearing, Diff Right & Left Hand Cup	2
55175C	Bearing, Pinion Head & Tail Cone	2
55437	Bearing, Pinion Head & Tail Cup	2
MUB5206TM	Bearing, Pinion Nose CRB	1
SLS-1878	Seal, Pinion	1
TL-0.5ML	Threadlocker	1
SEALANT	RTV Silicone	1

NDK191R-V100		
Part No.	Description	Qty.
3984	Bearing, Diff Right & Left Hand Cone	2
3920	Bearing, Diff Right & Left Hand Cup	2
55175C	Bearing, Pinion Head & Tail Cone	2
55437	Bearing, Pinion Head & Tail Cup	2
MUB5206TM	Bearing, Pinion Nose CRB	1
SLS-1878	Seal, Pinion	1

NDK192R		
Part No.	Description	Qty.
47890	Bearing, Diff Right & Left Hand Cone	2
47820	Bearing, Diff Right & Left Hand Cup	2
72225C	Bearing, Pinion Head & Pinion Tail Cone	2
72487	Bearing, Pinion Head & Pinion Tail Cup	2
MUB1307UBM	Bearing, Pinion Nose CRB	1
SLS-1782	Seal, Pinion	1
SLS-1879	Seal, Pinion	1
TL-0.5ML	Threadlocker	1
SEALANT	RTV Silicone	1

NDK192R-V100		
Part No.	Description	Qty.
47890	Bearing, Diff Right & Left Hand Cone	2
47820	Bearing, Diff Right & Left Hand Cup	2
72225C	Bearing, Pinion Head & Pinion Tail Cone	2
72487	Bearing, Pinion Head & Pinion Tail Cup	2
MUB1307UBM	Bearing, Pinion Nose CRB	1
SLS-1782	Seal, Pinion	1
SLS-1879	Seal, Pinion	1

NDK192RB		
Part No.	Description	Qty.
47890	Bearing, Diff Right & Left Hand Cone	2
47820	Bearing, Diff Right & Left Hand Cup	2
72225C	Bearing, Pinion Head & Pinion Tail Cone	2
72487	Bearing, Pinion Head & Pinion Tail Cup	2
MUB1307UBM	Bearing, Pinion Nose CRB	1
SLS-1703	Seal, Pinion	1
TL-0.5ML	Threadlocker	1
SEALANT	RTV Silicone	1

NDK192RB-V100		
Part No.	Description	Qty.
47890	Bearing, Diff Right & Left Hand Cone	2
47820	Bearing, Diff Right & Left Hand Cup	2
72225C	Bearing, Pinion Head & Pinion Tail Cone	2
72487	Bearing, Pinion Head & Pinion Tail Cup	2
MUB1307UBM	Bearing, Pinion Nose CRB	1
SLS-1703	Seal, Pinion	1

NDK194F		
Part No.	Description	Qty.
JM716649	Bearing, Diff Right & Left Hand Cone	2
JM716610	Bearing, Diff Right & Left Hand Cup	2
72212C	Bearing, Pinion Head & Tail Cone	2
72487	Bearing, Pinion Head & Tail Cup	2
RU1570UM	Bearing, Pinion Nose CRB	1
JLM710949C	Bearing, Drive Gear Front Cone	1
JLM710910	Bearing, Drive Gear Front Cup	1
JM511946	Bearing, Input Shaft Cone	1
JM511910	Bearing, Input Shaft Cup	1
SLS-1862	Seal, Input Shaft	1
SLS-1863	Seal, Thrushaft	1
TL-0.5ML	Threadlocker	1
SEALANT	RTV Silicone	1

NDK194F-V100		
Part No.	Description	Qty.
JM716649	Bearing, Diff Right & Left Hand Cone	2
JM716610	Bearing, Diff Right & Left Hand Cup	2
72212C	Bearing, Pinion Head & Tail Cone	2
72487	Bearing, Pinion Head & Tail Cup	2
RU1570UM	Bearing, Pinion Nose CRB	1
JLM710949C	Bearing, Drive Gear Front Cone	1
JLM710910	Bearing, Drive Gear Front Cup	1
JM511946	Bearing, Input Shaft Cone	1
JM511910	Bearing, Input Shaft Cup	1
SLS-1862	Seal, Input Shaft	1
SLS-1863	Seal, Thrushaft	1

NDK194R		
Part No.	Description	Qty.
JM716649	Bearing, Diff Right & Left Hand Cone	2
JM716610	Bearing, Diff Right & Left Hand Cup	2
65237	Bearing, Pinion Head Cone	1
65500	Bearing, Pinion Head Cup	1
72201C	Bearing, Pinion Tail Cone	1
72487	Bearing, Pinion Tail Cup	1
A-4223	Seal, Pinion w/ Sleeve	1
TL-0.5ML	Threadlocker	1
SEALANT	RTV Silicone	1

NDK194R-V100		
Part No.	Description	Qty.
JM716649	Bearing, Diff Right & Left Hand Cone	2
JM716610	Bearing, Diff Right & Left Hand Cup	2
65237	Bearing, Pinion Head Cone	1
65500	Bearing, Pinion Head Cup	1
72201C	Bearing, Pinion Tail Cone	1
72487	Bearing, Pinion Tail Cup	1
A-4223	Seal, Pinion w/ Sleeve	1

NDK194RA		
Part No.	Description	Qty.
JM716649	Bearing, Diff Right & Left Cone	2
JM716610	Bearing, Diff Right & Left Cup	2
65237	Bearing, Pinion Head Cone	1
65500	Bearing, Pinion Head Cup	1
72225C	Bearing, Pinion Tail Cone	1
72487	Bearing, Pinion Tail Cup	1
SLS-1952	Seal, Pinon	1
TL-0.5ML	Threadlocker	1
SEALANT	RTV Silicone	1

NDK194RA-V100		
Part No.	Description	Qty.
JM716649	Bearing, Diff Right & Left Cone	2
JM716610	Bearing, Diff Right & Left Cup	2
65237	Bearing, Pinion Head Cone	1
65500	Bearing, Pinion Head Cup	1
72225C	Bearing, Pinion Tail Cone	1
72487	Bearing, Pinion Tail Cup	1
SLS-1952	Seal, Pinon	1

NDK194RB		
Part No.	Description	Qty.
JM716649	Bearing, Diff Right & Left Cone	2
JM716610	Bearing, Diff Right & Left Cup	2
72212C	Bearing, Pinion Head & Tail Cone	2
72487	Bearing, Pinion Head & Tail Cup	2
RU1570UM	Bearing, Pinion Nose CRB	1
SLS-1952	Seal, Pinon	1
TL-0.5ML	Threadlocker	1
SEALANT	RTV Silicone	1

NDK194RB-V100		
Part No.	Description	Qty.
JM716649	Bearing, Diff Right & Left Cone	2
JM716610	Bearing, Diff Right & Left Cup	2
72212C	Bearing, Pinion Head & Tail Cone	2
72487	Bearing, Pinion Head & Tail Cup	2
RU1570UM	Bearing, Pinion Nose CRB	1
SLS-1952	Seal, Pinon	1

NDK196		
Part No.	Description	Qty.
567	Bearing, Diff Right Hand Cone	1
563	Bearing, Diff Right Hand Cup	1
497	Bearing, Diff Left Hand Cone	1
493	Bearing, Diff Left Hand Cup	1
72218C	Bearing, Pinion Head Cone	1
72487	Bearing, Pinion Head Cup	1
HM807049	Bearing, Pinion Tail Cone	1
HM807010	Bearing, Pinion Tail Cup	1
MUB1307UBM	Bearing, Pinion Nose	1
3979	Bearing, Input Shaft Cone	1
JM511910	Bearing, Input Shaft Cup	1
29675	Bearing, Output Shaft Inner Cone	1
29620	Bearing, Output Shaft Inner Cup	1
MA1209TV	Bearing, Output Shaft Outer	1
127719-NTN	Seal, Input Shaft	1
12720-NTN	Seal, Output Shaft	1
SEALANT	RTV Silicone	1

NDK196-V100		
Part No.	Description	Qty.
567	Bearing, Diff Right Hand Cone	1
563	Bearing, Diff Right Hand Cup	1
497	Bearing, Diff Left Hand Cone	1
493	Bearing, Diff Left Hand Cup	1
72218C	Bearing, Pinion Head Cone	1
72487	Bearing, Pinion Head Cup	1
HM807049	Bearing, Pinion Tail Cone	1
HM807010	Bearing, Pinion Tail Cup	1
MUB1307UBM	Bearing, Pinion Nose	1
3979	Bearing, Input Shaft Cone	1
JM511910	Bearing, Input Shaft Cup	1
29675	Bearing, Output Shaft Inner Cone	1
29620	Bearing, Output Shaft Inner Cup	1
127719-NTN	Seal, Input Shaft	1

NDK200F		
Part No.	Description	Qty.
47890	Bearing, Diff Right & Left Hand Cone	2
47820	Bearing, Diff Right & Left Hand Cup	2
72225C	Bearing, Pinion Head & Pinion Tail Cone	2
72487	Bearing, Pinion Head & Pinion Tail Cup	2
MUB1307UBM	Bearing, Pinion Nose CRB	1
3877	Bearing, Idler Gear Cone	2
3820	Bearing, Idler Gear Cup	2
W4860	Washer, Power Divider Front Side Gear Trust	1
TRA4860	Washer, Power Divider Front Side Gear Trust	2
28985	Bearing, Power Divider Case Intermediate Cone	1
28921	Bearing, Power Divider Case Intermediate Cup	1
JLM710949C	Bearing, Power Divider Cone	2
JLM710910	Bearing, Power Divider Cup	2
6926LU	Bearing, Power Divider Intermediate Disc Rear DGBB	1
6210	Bearing, Output Shaft DGBB	1
472HH100	Seal, Input Shaft	1
472HH101	Seal, Thrushaft	1
TL-0.5ML	Threadlocker	1
SEALANT	RTV Silicone	1

NDK200F-V100		
Part No.	Description	Qty.
47890	Bearing, Diff Right & Left Hand Cone	2
47820	Bearing, Diff Right & Left Hand Cup	2
72225C	Bearing, Pinion Head & Pinion Tail Cone	2
72487	Bearing, Pinion Head & Pinion Tail Cup	2
MUB1307UBM	Bearing, Pinion Nose CRB	1
3877	Bearing, Idler Gear Cone	2
3820	Bearing, Idler Gear Cup	2
W4860	Washer, Power Divider Front Side Gear Trust	1
TRA4860	Washer, Power Divider Front Side Gear Trust	2
28985	Bearing, Power Divider Case Intermediate Cone	1
28921	Bearing, Power Divider Case Intermediate Cup	1
JLM710949C	Bearing, Power Divider Cone	2
JLM710910	Bearing, Power Divider Cup	2
6926LU	Bearing, Power Divider Intermediate Disc Rear DGBB	1
6210	Bearing, Output Shaft DGBB	1
472HH100	Seal, Input Shaft	1
472HH101	Seal, Thrushaft	1

NDK200FA		
Part No.	Description	Qty.
47890	Bearing, Diff Right & Left Hand Cone	2
47820	Bearing, Diff Right & Left Hand Cup	2
72225C	Bearing, Pinion Head & Pinion Tail Cone	2
72487	Bearing, Pinion Head & Pinion Tail Cup	2
MUB1307UBM	Bearing, Pinion Nose CRB	1
M802048	Bearing, Idler Gear Cone	2
M802011	Bearing, Idler Gear Cup	2
W4860	Washer, Power Divider Front Side Gear Trust	1
TRA4860	Washer, Power Divider Front Side Gear Trust	2
28985	Bearing, Power Divider Case Intermediate Cone	1
28921	Bearing, Power Divider Case Intermediate Cup	1
JLM710949C	Bearing, Power Divider Cone	2
JLM710910	Bearing, Power Divider Cup	2
6926LU	Bearing, Power Divider Intermediate Disc Rear DGBB	1
6210	Bearing, Output Shaft DGBB	1
472HH100	Seal, Input Shaft	1
472HH101	Seal, Thrushaft	1
TL-0.5ML	Threadlocker	1
SEALANT	RTV Silicone	1

NDK200FA-V100		
Part No.	Description	Qty.
47890	Bearing, Diff Right & Left Hand Cone	2
47820	Bearing, Diff Right & Left Hand Cup	2
72225C	Bearing, Pinion Head & Pinion Tail Cone	2
72487	Bearing, Pinion Head & Pinion Tail Cup	2
MUB1307UBM	Bearing, Pinion Nose CRB	1
M802048	Bearing, Idler Gear Cone	2
M802011	Bearing, Idler Gear Cup	2
W4860	Washer, Power Divider Front Side Gear Trust	1
TRA4860	Washer, Power Divider Front Side Gear Trust	2
28985	Bearing, Power Divider Case Intermediate Cone	1
28921	Bearing, Power Divider Case Intermediate Cup	1
JLM710949C	Bearing, Power Divider Cone	2
JLM710910	Bearing, Power Divider Cup	2
6926LU	Bearing, Power Divider Intermediate Disc Rear DGBB	1
6210	Bearing, Output Shaft DGBB	1
472HH100	Seal, Input Shaft	1
472HH101	Seal, Thrushaft	1

NDK201F		
Part No.	Description	Qty.
56425	Bearing, Diff Right & Left Hand Cone	2
56650	Bearing, Diff Right & Left Hand Cup	2
H715343	Bearing, Pinion Head Cone	1
H715311	Bearing, Pinion Head Cup	1
HM813844	Bearing, Pinion Tail Cone	1
HM813810	Bearing, Pinion Tail Cup	1
WUB61308UM	Bearing, Pinion Nose CRB	1
3877	Bearing, Idler Gear Cone	2
3820	Bearing, Idler Gear Cup	2
28985	Bearing, Power Divider Case Intermediate Cone	1
28921	Bearing, Power Divider Case Intermediate Cup	1
JLM710949C	Bearing, Power Divider Cone	2
JLM710910	Bearing, Power Divider Cup	2
6926LU	Bearing, Power Divider Inermedial Disc Rear Brg DGBB	1
6210	Bearing, Output Shaft DGBB	1
W4860	Washer, Power Divider Front Side Gear	1
TRA4860	Washer, Power Divider Front Side Gear	2
SLS-1716	Seal, Input Shaft	1
SLS-1782	Seal, Thrushaft	1
TL-0.5ML	Threadlocker	1
SEALANT	RTV Silicone	1

NDK201F-V100		
Part No.	Description	Qty.
56425	Bearing, Diff Right & Left Hand Cone	2
56650	Bearing, Diff Right & Left Hand Cup	2
H715343	Bearing, Pinion Head Cone	1
H715311	Bearing, Pinion Head Cup	1
HM813844	Bearing, Pinion Tail Cone	1
HM813810	Bearing, Pinion Tail Cup	1
WUB61308UM	Bearing, Pinion Nose CRB	1
3877	Bearing, Idler Gear Cone	2
3820	Bearing, Idler Gear Cup	2
28985	Bearing, Power Divider Case Intermediate Cone	1
28921	Bearing, Power Divider Case Intermediate Cup	1
JLM710949C	Bearing, Power Divider Cone	2
JLM710910	Bearing, Power Divider Cup	2
6926LU	Bearing, Power Divider Inermedial Disc Rear Brg DGBB	1
6210	Bearing, Output Shaft DGBB	1
W4860	Washer, Power Divider Front Side Gear	1
TRA4860	Washer, Power Divider Front Side Gear	2
SLS-1716	Seal, Input Shaft	1
SLS-1782	Seal, Thrushaft	1

NDK201FA		
Part No.	Description	Qty.
56425	Bearing, Diff Right & Left Hand Cone	2
56650	Bearing, Diff Right & Left Hand Cup	2
H715343	Bearing, Pinion Head Cone	1
H715311	Bearing, Pinion Head Cup	1
HM813844	Bearing, Pinion Tail Cone	1
HM813810	Bearing, Pinion Tail Cup	1
WUB61308UM	Bearing, Pinion Nose CRB	1
M802048	Bearing, Idler Gear Cone	2
M802011	Bearing, Idler Gear Cup	2
28985	Bearing, Power Divider Case Intermediate Cone	1
28921	Bearing, Power Divider Case Intermediate Cup	1
JLM710949C	Bearing, Power Divider Cone	2
JLM710910	Bearing, Power Divider Cup	2
6926LU	Bearing, Power Divider Inermedial Disc Rear Brg DGBB	1
6210	Bearing, Output Shaft DGBB	1
W4860	Washer, Power Divider Front Side Gear	1
TRA4860	Washer, Power Divider Front Side Gear	2
SLS-1716	Seal, Input Shaft	1
SLS-1715	Seal, Thrushaft	1
TL-0.5ML	Threadlocker	1
SEALANT	RTV Silicone	1

NDK201FA-V100		
Part No.	Description	Qty.
56425	Bearing, Diff Right & Left Hand Cone	2
56650	Bearing, Diff Right & Left Hand Cup	2
H715343	Bearing, Pinion Head Cone	1
H715311	Bearing, Pinion Head Cup	1
HM813844	Bearing, Pinion Tail Cone	1
HM813810	Bearing, Pinion Tail Cup	1
WUB61308UM	Bearing, Pinion Nose CRB	1
M802048	Bearing, Idler Gear Cone	2
M802011	Bearing, Idler Gear Cup	2
28985	Bearing, Power Divider Case Intermediate Cone	1
28921	Bearing, Power Divider Case Intermediate Cup	1
JLM710949C	Bearing, Power Divider Cone	2
JLM710910	Bearing, Power Divider Cup	2
6926LU	Bearing, Power Divider Inermedial Disc Rear Brg DGBB	1
6210	Bearing, Output Shaft DGBB	1
W4860	Washer, Power Divider Front Side Gear	1
TRA4860	Washer, Power Divider Front Side Gear	2
SLS-1716	Seal, Input Shaft	1
SLS-1715	Seal, Thrushaft	1



NDK201R		
Part No.	Description	Qty.
56425	Bearing, Diff Right & Left Hand Cone	2
56650	Bearing, Diff Right & Left Hand Cup	2
H715343	Bearing, Pinion Head Cone	1
H715311	Bearing, Pinion Head Cup	1
HM813844	Bearing, Pinion Tail Cone	1
HM813810	Bearing, Pinion Tail Cup	1
WUB61308UM	Bearing, Pinion Nose CRB	1
SLS-1703	Seal, Input Shaft	1
TL-0.5ML	Threadlocker	1
SEALANT	RTV Silicone	1

NDK201R-V100		
Part No.	Description	Qty.
56425	Bearing, Diff Right & Left Hand Cone	2
56650	Bearing, Diff Right & Left Hand Cup	2
H715343	Bearing, Pinion Head Cone	1
H715311	Bearing, Pinion Head Cup	1
HM813844	Bearing, Pinion Tail Cone	1
HM813810	Bearing, Pinion Tail Cup	1
WUB61308UM	Bearing, Pinion Nose CRB	1
SLS-1703	Seal, Input Shaft	1

NDK202		
Part No.	Description	Qty.
3984	Bearing, Diff Right & Left Hand Cone	2
3925	Bearing, Diff Right & Left Hand Cup	2
HM903249	Bearing, Pinion Head & Tail Cone	2
HM903210	Bearing, Pinion Head & Tail Cup	2
MUB5205UM	Bearing, Pinion Nose CRB	1
SLS-1951	Seal, Pinion	1
SLS-1958	Seal, Pinion	1
TL-0.5ML	Threadlocker	1
SEALANT	RTV Silicone	1

NDK202-V100		
Part No.	Description	Qty.
3984	Bearing, Diff Right & Left Hand Cone	2
3925	Bearing, Diff Right & Left Hand Cup	2
HM903249	Bearing, Pinion Head & Tail Cone	2
HM903210	Bearing, Pinion Head & Tail Cup	2
MUB5205UM	Bearing, Pinion Nose CRB	1
SLS-1951	Seal, Pinion	1
SLS-1958	Seal, Pinion	1

NDK204F		
Part No.	Description	Qty.
HM516449C	Bearing, Diff Right & Left Hand Cone	2
HM516410	Bearing, Diff Right & Left Hand Cup	2
42350	Bearing, Pinion Head & Tail Cone	2
42584	Bearing, Pinion Head & Tail Cup	2
MR1213EL	Bearing, Pinion Nose CRB	1
641	Bearing, Cross Shaft Right Cone	2
632	Bearing, Cross Shaft Right Cup	2
MU1221UM	Bearing, Cross Shaft Left CRB	1
392	Bearing, Input Shaft Cone	2
394A	Bearing, Input Shaft Cup	2
385A	Bearing, Thrushaft Cone	2
382A	Bearing, Thrushaft Cup	2
SLS-1956	Seal, Input Shaft	1
SLS-1957	Seal, Thrushaft	1
TL-0.5ML	Threadlocker	1
SEALANT	RTV Silicone	1

NDK204F-V100		
Part No.	Description	Qty.
HM516449C	Bearing, Diff Right & Left Hand Cone	2
HM516410	Bearing, Diff Right & Left Hand Cup	2
42350	Bearing, Pinion Head & Tail Cone	2
42584	Bearing, Pinion Head & Tail Cup	2
MR1213EL	Bearing, Pinion Nose CRB	1
641	Bearing, Cross Shaft Right Cone	2
632	Bearing, Cross Shaft Right Cup	2
MU1221UM	Bearing, Cross Shaft Left CRB	1
392	Bearing, Input Shaft Cone	2
394A	Bearing, Input Shaft Cup	2
385A	Bearing, Thrushaft Cone	2
382A	Bearing, Thrushaft Cup	2
SLS-1956	Seal, Input Shaft	1
SLS-1957	Seal, Thrushaft	1

NDK204R		
Part No.	Description	Qty.
HM516449C	Bearing, Diff Right & Left Cone	2
HM516410	Bearing, Diff Right & Left Cup	2
H715345	Bearing, Pinion Head Cone	1
H715311	Bearing, Pinion Head Cup	1
HM807046	Bearing, Pinion Tail Cone	1
HM807010	Bearing, Pinion Tail Cup	1
65237	Bearing, Cross Shaft Right & Left Cone	2
65500	Bearing, Cross Shaft Right & Left Cup	2
SLS-1743	Seal, Pinion	1
TL-0.5ML	Threadlocker	1
SEALANT	RTV Silicone	1

NDK204R-V100		
Part No.	Description	Qty.
HM516449C	Bearing, Diff Right & Left Cone	2
HM516410	Bearing, Diff Right & Left Cup	2
H715345	Bearing, Pinion Head Cone	1
H715311	Bearing, Pinion Head Cup	1
HM807046	Bearing, Pinion Tail Cone	1
HM807010	Bearing, Pinion Tail Cup	1
65237	Bearing, Cross Shaft Right & Left Cone	2
65500	Bearing, Cross Shaft Right & Left Cup	2
SLS-1743	Seal, Pinion	1

NDK205		
Part No.	Description	Qty.
47687	Bearing, Diff Right Hand Cone	1
47623A	Bearing, Diff Right Hand Cup	1
HM516448	Bearing, Diff Left Hand Cone	1
HM516414B	Bearing, Diff Left Hand Cup	1
5760	Bearing, Pinion Head Cone	1
5735	Bearing, Pinion Head Cup	1
5575	Bearing, Pinion Tail Cone	1
552A	Bearing, Pinion Tail Cup	1
621	Cross Shaft Right Hand Cone	1
612	Cross Shaft Right Hand Cup	1
H715345	Cross Shaft Left Hand Cone	1
H715313W	Cross Shaft Left Hand Cup	1
88AX457-NTN	Seal Input Shaft	1
OK-205	O-Ring Set	1
MSC-1671	RTV Silicone	1

NDK205-V100		
Part No.	Description	Qty.
47687	Bearing, Diff Right Hand Cone	1
47623A	Bearing, Diff Right Hand Cup	1
HM516448	Bearing, Diff Left Hand Cone	1
HM516414B	Bearing, Diff Left Hand Cup	1
5760	Bearing, Pinion Head Cone	1
5735	Bearing, Pinion Head Cup	1
5575	Bearing, Pinion Tail Cone	1
552A	Bearing, Pinion Tail Cup	1
621	Cross Shaft Right Hand Cone	1
612	Cross Shaft Right Hand Cup	1
H715345	Cross Shaft Left Hand Cone	1
H715313W	Cross Shaft Left Hand Cup	1
88AX457-NTN	Seal Input Shaft	1
OK-205	O-Ring Set	1

NDK205A		
Part No.	Description	Qty.
HM516448	Bearing, Diff Right Hand Cone	1
HM516414A	Bearing, Diff Right Hand Cup	1
HM516448	Bearing, Diff Left Hand Cone	1
HM516414B	Bearing, Diff Left Hand Cup	1
5760	Bearing, Pinion Head Cone	1
5735	Bearing, Pinion Head Cup	1
5575	Bearing, Pinion Tail Cone	1
552A	Bearing, Pinion Tail Cup	1
621	Cross Shaft Right Hand Cone	1
612	Cross Shaft Right Hand Cup	1
H715345	Cross Shaft Left Hand Cone	1
H715313W	Cross Shaft Left Hand Cup	1
SLS-1708	Seal Input Shaft	1
SLS-1704	O-Ring	1
SLS-1713	O-Ring	1
SLS-1714	O-Ring	1
TL-0.5ML	Threadlocker	1
SEALANT	RTV Silicone	1

NDK205A-V100		
Part No.	Description	Qty.
HM516448	Bearing, Diff Right Hand Cone	1
HM516414A	Bearing, Diff Right Hand Cup	1
HM516448	Bearing, Diff Left Hand Cone	1
HM516414B	Bearing, Diff Left Hand Cup	1
5760	Bearing, Pinion Head Cone	1
5735	Bearing, Pinion Head Cup	1
5575	Bearing, Pinion Tail Cone	1
552A	Bearing, Pinion Tail Cup	1
621	Cross Shaft Right Hand Cone	1
612	Cross Shaft Right Hand Cup	1
H715345	Cross Shaft Left Hand Cone	1
H715313W	Cross Shaft Left Hand Cup	1
SLS-1708	Seal Input Shaft	1
SLS-1704	O-Ring	1
SLS-1713	O-Ring	1
SLS-1714	O-Ring	1

NDK206		
Part No.	Description	Qty.
47687	Bearing, Diff Right Hand Cone	1
47623A	Bearing, Diff Right Hand Cup	1
HM516448	Bearing, Diff Left Hand Cone	1
HM516414B	Bearing, Diff Left Hand Cup	1
576	Bearing, Pinion Head Cone	1
572	Bearing, Pinion Head Cup	1
497	Bearing, Pinion Tail Cone	1
492A	Bearing, Pinion Tail Cup	1
621	Cross Shaft Right Hand Cone	1
612	Cross Shaft Right Hand Cup	1
H715345	Cross Shaft Left Hand Cone	1
H715313W	Cross Shaft Left Hand Cup	1
TMB211	Bearing, Output Shaft (Drive Gear Frt)	1
1213L#BCA	Bearing, Input Shaft	1
88AX458	Seal Input Shaft	1
88AX319P2	Seal, Thrushaft	1
OK-206	O-Ring Set	1
TL-0.5ML	Threadlocker	1
MSC-1671	RTV Silicone	1

NDK206-V100		
Part No.	Description	Qty.
47687	Bearing, Diff Right Hand Cone	1
47623A	Bearing, Diff Right Hand Cup	1
HM516448	Bearing, Diff Left Hand Cone	1
HM516414B	Bearing, Diff Left Hand Cup	1
576	Bearing, Pinion Head Cone	1
572	Bearing, Pinion Head Cup	1
497	Bearing, Pinion Tail Cone	1
492A	Bearing, Pinion Tail Cup	1
621	Cross Shaft Right Hand Cone	1
612	Cross Shaft Right Hand Cup	1
H715345	Cross Shaft Left Hand Cone	1
H715313W	Cross Shaft Left Hand Cup	1
TMB211	Bearing, Output Shaft (Drive Gear Frt)	1
1213L#BCA	Bearing, Input Shaft	1
88AX458	Seal Input Shaft	1
88AX319P2	Seal, Thrushaft	1
OK-206	O-Ring Set	1

NDK206A		
Part No.	Description	Qty.
HM516448	Bearing, Diff Right Hand Cone	1
HM516414A	Bearing, Diff Right Hand Cup	1
HM516448	Bearing, Diff Left Hand Cone	1
HM516414B	Bearing, Diff Left Hand Cup	1
576	Bearing, Pinion Head Cone	1
572	Bearing, Pinion Head Cup	1
497	Bearing, Pinion Tail Cone	1
492A	Bearing, Pinion Tail Cup	1
621	Cross Shaft Right Hand Cone	1
612	Cross Shaft Right Hand Cup	1
H715345	Cross Shaft Left Hand Cone	1
H715313W	Cross Shaft Left Hand Cup	1
TMB211	Bearing, Output Shaft, DGGB	1
1213L#BCA	Bearing, Input Shaft, DGGB	1
SLS-1709	Seal, Input Shaft	1
SLS-1710	Seal, Thru Shaft	1
SLS-1712	O-Ring	1
SLS-1704	O-Ring	1
SLS-1713	O-Ring	1
SLS-1714	O-Ring	1
TL-0.5ML	Threadlocker	1
SEALANT	RTV Silicone	1

NDK206A-V100		
Part No.	Description	Qty.
HM516448	Bearing, Diff Right Hand Cone	1
HM516414A	Bearing, Diff Right Hand Cup	1
HM516448	Bearing, Diff Left Hand Cone	1
HM516414B	Bearing, Diff Left Hand Cup	1
576	Bearing, Pinion Head Cone	1
572	Bearing, Pinion Head Cup	1
497	Bearing, Pinion Tail Cone	1
492A	Bearing, Pinion Tail Cup	1
621	Cross Shaft Right Hand Cone	1
612	Cross Shaft Right Hand Cup	1
H715345	Cross Shaft Left Hand Cone	1
H715313W	Cross Shaft Left Hand Cup	1
TMB211	Bearing, Output Shaft, DGGB	1
1213L#BCA	Bearing, Input Shaft, DGGB	1
SLS-1709	Seal, Input Shaft	1
SLS-1710	Seal, Thru Shaft	1
SLS-1712	O-Ring	1
SLS-1704	O-Ring	1
SLS-1713	O-Ring	1
SLS-1714	O-Ring	1

NDK207		
Part No.	Description	Qty.
56425	Bearing, Diff Right Hand Cone	1
56650	Bearing, Diff Right Hand Cup	1
497	Bearing, Diff Left Hand Cone	1
493	Bearing, Diff Left Hand Cup	1
72218C	Bearing, Pinion Head Cone	1
72487	Bearing, Pinion Head Cup	1
HM807049	Bearing, Pinion Tail Cone	1
HM807010	Bearing, Pinion Tail Cup	1
WUB61307UM	Bearing, Pinion Nose, CRB	1
3979	Bearing, Input Shaft Cone	1
JM511910	Bearing, Input Shaft Cup	1
29675	Bearing, Output Shaft Front Cone	1
29620	Bearing, Output Shaft Front Cup	1
MA1209TV (Inner Ring)*	Bearing, Output Shaft Rear, CRB	1
MA1209TV (Outer Ring)*	Bearing, Output Shaft Rear, CRB	1
127720	Seal, Input Shaft	1
127719	Seal, Thrushaft	1
TL-0.5ML	Threadlocker	1
SEALANT	RTV Silicone	1

NDK207-V100		
Part No.	Description	Qty.
56425	Bearing, Diff Right Hand Cone	1
56650	Bearing, Diff Right Hand Cup	1
497	Bearing, Diff Left Hand Cone	1
493	Bearing, Diff Left Hand Cup	1
72218C	Bearing, Pinion Head Cone	1
72487	Bearing, Pinion Head Cup	1
HM807049	Bearing, Pinion Tail Cone	1
HM807010	Bearing, Pinion Tail Cup	1
WUB61307UM	Bearing, Pinion Nose, CRB	1
3979	Bearing, Input Shaft Cone	1
JM511910	Bearing, Input Shaft Cup	1
29675	Bearing, Output Shaft Front Cone	1
29620	Bearing, Output Shaft Front Cup	1
MA1209TV (Inner Ring)*	Bearing, Output Shaft Rear, CRB	1
MA1209TV (Outer Ring)*	Bearing, Output Shaft Rear, CRB	1
127720	Seal, Input Shaft	1
127719	Seal, Thrushaft	1

NDK208		
Part No.	Description	Qty.
665	Bearing, Diff Right Hand Cone	1
653	Bearing, Diff Right Hand Cup	1
42381	Bearing, Diff Left Hand Cone	1
42584	Bearing, Diff Left Hand Cup	1
72212C	Bearing, Pinion Head & Tail Cone	2
72487	Bearing, Pinion Head & Tail Cup	2
WUS61308UM	Bearing, Pinion Nose CRB	1
33275	Bearing, Output Shaft Front Cone	1
33472	Bearing, Output Shaft Front Cup	1
JM511946	Bearing, Input Shaft Cone	1
JM511910	Bearing, Input Shaft Cup	1
MA1211UB	Bearing, Output Shaft Rear CRB	1
MU1309CB	Bearing, Pinion Forward CRB	1
SLS-1773	Seal, Input Shaft	1
SLS-1772	Seal, Thrushaft	1
TL-0.5ML	Threadlocker	1
SEALANT	RTV Silicone	1

NDK208-V100		
Part No.	Description	Qty.
665	Bearing, Diff Right Hand Cone	1
653	Bearing, Diff Right Hand Cup	1
42381	Bearing, Diff Left Hand Cone	1
42584	Bearing, Diff Left Hand Cup	1
72212C	Bearing, Pinion Head & Tail Cone	2
72487	Bearing, Pinion Head & Tail Cup	2
WUS61308UM	Bearing, Pinion Nose CRB	1
33275	Bearing, Output Shaft Front Cone	1
33472	Bearing, Output Shaft Front Cup	1
JM511946	Bearing, Input Shaft Cone	1
JM511910	Bearing, Input Shaft Cup	1
MA1211UB	Bearing, Output Shaft Rear CRB	1
MU1309CB	Bearing, Pinion Forward CRB	1
SLS-1773	Seal, Input Shaft	1
SLS-1772	Seal, Thrushaft	1

NDK208A		
Part No.	Description	Qty.
665	Bearing, Diff Right Hand Cone	1
653	Bearing, Diff Right Hand Cup	1
42381	Bearing, Diff Left Hand Cone	1
42584	Bearing, Diff Left Hand Cup	1
72212C	Bearing, Pinion Head & Tail Cone	2
72487	Bearing, Pinion Head & Tail Cup	2
WUS61308UM	Bearing, Pinion Nose CRB	1
6313	Bearing, Input Shaft DGBB	1
33275	Bearing, Output Shaft Front Cone	1
33472	Bearing, Output Shaft Front Cup	1
MA1211UBVV1	Bearing, Output Shaft Rear CRB	1
MU1309CBXV1	Bearing, Pinion Forward CRB	1
SLS-1772	Seal, Input Shaft	1
SLS-1786	Seal, Thrushaft	1
TL-0.5ML	Threadlocker	1
SEALANT	RTV Silicone	1

NDK208A-V100		
Part No.	Description	Qty.
665	Bearing, Diff Right Hand Cone	1
653	Bearing, Diff Right Hand Cup	1
42381	Bearing, Diff Left Hand Cone	1
42584	Bearing, Diff Left Hand Cup	1
72212C	Bearing, Pinion Head & Tail Cone	2
72487	Bearing, Pinion Head & Tail Cup	2
WUS61308UM	Bearing, Pinion Nose CRB	1
6313	Bearing, Input Shaft DGBB	1
33275	Bearing, Output Shaft Front Cone	1
33472	Bearing, Output Shaft Front Cup	1
MA1211UBVV1	Bearing, Output Shaft Rear CRB	1
MU1309CBXV1	Bearing, Pinion Forward CRB	1
SLS-1772	Seal, Input Shaft	1
SLS-1786	Seal, Thrushaft	1

NDK209		
Part No.	Description	Qty.
68462	Bearing, Diff Right Hand Cone	1
68712	Bearing, Diff Right Hand Cup	1
42346	Bearing, Diff Left Hand Cone	1
42584	Bearing, Diff Left Hand Cup	1
72212C	Bearing, Pinion Head & Pinion Tail Cone	2
72487	Bearing, Pinion Head & Pinion Tail Cup	2
WUS61308UM	Bearing, Pinion Nose, CRB	1
MU1309CBVV1 (Inner Ring)*	Bearing, Pinon Forward CRB-IR	1
MU1309CBVV1 (Outer Ring)*	Bearing, Pinion Forward CRB-OR	1
6313	Bearing, Input Shaft DGBB	1
32275	Bearing, Front Output Shaft Front Cone	1
33472	Bearing, Front Output Shaft Front Cup	1
MA1211UBVV1	Bearing, Front Output Shaft Rear CRB	1
SLS-1780	Seal, Input Shaft	1
SLS-1781	Seal, Thrushaft	1
TL-0.5ML	Threadlocker	1
SEALANT	RTV Silicone	1

NDK209-V100		
Part No.	Description	Qty.
68462	Bearing, Diff Right Hand Cone	1
68712	Bearing, Diff Right Hand Cup	1
42346	Bearing, Diff Left Hand Cone	1
42584	Bearing, Diff Left Hand Cup	1
72212C	Bearing, Pinion Head & Pinion Tail Cone	2
72487	Bearing, Pinion Head & Pinion Tail Cup	2
WUS61308UM	Bearing, Pinion Nose, CRB	1
MU1309CBVV1 (Inner Ring)*	Bearing, Pinon Forward CRB-IR	1
MU1309CBVV1 (Outer Ring)*	Bearing, Pinion Forward CRB-OR	1
6313	Bearing, Input Shaft DGBB	1
32275	Bearing, Front Output Shaft Front Cone	1
33472	Bearing, Front Output Shaft Front Cup	1
MA1211UBVV1	Bearing, Front Output Shaft Rear CRB	1
SLS-1780	Seal, Input Shaft	1
SLS-1781	Seal, Thrushaft	1

\* LINE ITEMS WITH "\*" COMBINE INTO INDUSTRY PART NUMBER MU1309CBVV1

\* LINE ITEMS WITH "\*" COMBINE INTO INDUSTRY PART NUMBER MU1309CBVV1

NDK210		
Part No.	Description	Qty.
68462	Bearing, Diff Right Hand Cone	1
68712	Bearing, Diff Right Hand Cup	1
42346	Bearing, Diff Left Hand Cone	1
42584	Bearing, Diff Left Hand Cup	1
72212C	Bearing, Pinion Head & Pinion Tail Cone	2
72487	Bearing, Pinion Head & Pinion Tail Cup	2
WUS61308UM	Bearing, Pinion Nose CRB	1
MU1309CBVV1 (Inner Ring)*	Bearing, Output Shaft Rear CRB-IR	1
MU1309CBVV1 (Outer Ring)*	Bearing, Output Shaft Rear CRB-OR	1
JM511946	Bearing, Input Shaft Cone	1
JM511910	Bearing, Input Shaft Cup	1
33275	Bearing, Front Output Shaft Front Cone	1
33472	Bearing, Front Output Shaft Front Cup	1
MA1211UBVV1	Bearing, Front Output Shaft Front CRB	1
SLS-1780	Seal, Input Shaft	1
SLS-1781	Seal, Thrushaft	1
TL-0.5ML	Threadlocker	1
SEALANT	RTV Silicone	1

\*LINE ITEMS WITH "\*" COMBINE INTO INDUSTRY PART NUMBER MU1309CBVV1

NDK210-V100		
Part No.	Description	Qty.
68462	Bearing, Diff Right Hand Cone	1
68712	Bearing, Diff Right Hand Cup	1
42346	Bearing, Diff Left Hand Cone	1
42584	Bearing, Diff Left Hand Cup	1
72212C	Bearing, Pinion Head & Pinion Tail Cone	2
72487	Bearing, Pinion Head & Pinion Tail Cup	2
WUS61308UM	Bearing, Pinion Nose CRB	1
MU1309CBVV1 (Inner Ring)*	Bearing, Output Shaft Rear CRB-IR	1
MU1309CBVV1 (Outer Ring)*	Bearing, Output Shaft Rear CRB-OR	1
JM511946	Bearing, Input Shaft Cone	1
JM511910	Bearing, Input Shaft Cup	1
33275	Bearing, Front Output Shaft Front Cone	1
33472	Bearing, Front Output Shaft Front Cup	1
MA1211UBVV1	Bearing, Front Output Shaft Front CRB	1
SLS-1780	Seal, Input Shaft	1
SLS-1781	Seal, Thrushaft	1

\*LINE ITEMS WITH "\*" COMBINE INTO INDUSTRY PART NUMBER MU1309CBVV1

NDK211F		
Part No.	Description	Qty.
68462	Bearing, Diff Right Hand Cone	1
68712	Bearing, Diff Right Hand Cup	1
42381	Bearing, Diff Left Hand Cone	1
42584	Bearing, Diff Left Hand Cup	1
72212C	Bearing, Pinion Head & Tail Cone	2
72487	Bearing, Pinion Head & Tail Cup	2
WUS61308UM	Bearing, Pinion Nose CRB	1
JM511946	Bearing, Input Shaft Cone	1
JM511910	Bearing, Input Shaft Cup	1
MU1309CV (Inner Ring)*	Bearing, Pinion Forward CRB	1
MU1309CV (Outer Ring)*	Bearing, Pinion Forward CRB	1
33275	Bearing, Output Shaft Front Cone	1
33472	Bearing, Output Shaft Front Cup	1
MA1211UB	Bearing, Output Shaft Rear CRB	1
SLS-1781	Seal, Input Shaft	1
SLS-1780	Seal, Thrushaft	1
TL-0.5ML	Threadlocker	1
SEALANT	RTV Silicone	1

\*LINE ITEMS WITH "\*" COMBINE INTO INDUSTRY PART NUMBER MU1309CV

NDK211F-V100		
Part No.	Description	Qty.
68462	Bearing, Diff Right Hand Cone	1
68712	Bearing, Diff Right Hand Cup	1
42381	Bearing, Diff Left Hand Cone	1
42584	Bearing, Diff Left Hand Cup	1
72212C	Bearing, Pinion Head & Tail Cone	2
72487	Bearing, Pinion Head & Tail Cup	2
WUS61308UM	Bearing, Pinion Nose CRB	1
JM511946	Bearing, Input Shaft Cone	1
JM511910	Bearing, Input Shaft Cup	1
MU1309CV (Inner Ring)*	Bearing, Pinion Forward CRB	1
MU1309CV (Outer Ring)*	Bearing, Pinion Forward CRB	1
33275	Bearing, Output Shaft Front Cone	1
33472	Bearing, Output Shaft Front Cup	1
MA1211UB	Bearing, Output Shaft Rear CRB	1
SLS-1781	Seal, Input Shaft	1
SLS-1780	Seal, Thrushaft	1

\*LINE ITEMS WITH "\*" COMBINE INTO INDUSTRY PART NUMBER MU1309CV

NDK211FA		
Part No.	Description	Qty.
68450	Bearing, Diff Right Hand Cone	1
68712	Bearing, Diff Right Hand Cup	1
42381	Bearing, Diff Left Hand Cone	1
42584	Bearing, Diff Left Hand Cup	1
72212C	Bearing, Pinion Head & Tail Cone	2
72487	Bearing, Pinion Head & Tail Cup	2
WUS61308UM	Bearing, Pinion Nose CRB	1
JM511946	Bearing, Input Shaft Cone	1
JM511910	Bearing, Input Shaft Cup	1
MU1309CV (Inner Ring)*	Bearing, Pinion Forward CRB	1
MU1309CV (Outer Ring)*	Bearing, Pinion Forward CRB	1
33275	Bearing, Output Shaft Front Cone	1
33472	Bearing, Output Shaft Front Cup	1
MA1211UB	Bearing, Output Shaft Rear CRB	1
SLS-1773	Seal, Input Shaft	1
SLS-1772	Seal, Thrushaft	1
TL-0.5ML	Threadlocker	1
SEALANT	RTV Silicone	1

\*LINE ITEMS WITH \*\* COMBINE INTO INDUSTRY PART NUMBER MU1309CV

NDK211FA-V100		
Part No.	Description	Qty.
68450	Bearing, Diff Right Hand Cone	1
68712	Bearing, Diff Right Hand Cup	1
42381	Bearing, Diff Left Hand Cone	1
42584	Bearing, Diff Left Hand Cup	1
72212C	Bearing, Pinion Head & Tail Cone	2
72487	Bearing, Pinion Head & Tail Cup	2
WUS61308UM	Bearing, Pinion Nose CRB	1
JM511946	Bearing, Input Shaft Cone	1
JM511910	Bearing, Input Shaft Cup	1
MU1309CV (Inner Ring)*	Bearing, Pinion Forward CRB	1
MU1309CV (Outer Ring)*	Bearing, Pinion Forward CRB	1
33275	Bearing, Output Shaft Front Cone	1
33472	Bearing, Output Shaft Front Cup	1
MA1211UB	Bearing, Output Shaft Rear CRB	1
SLS-1773	Seal, Input Shaft	1
SLS-1772	Seal, Thrushaft	1

\*LINE ITEMS WITH \*\* COMBINE INTO INDUSTRY PART NUMBER MU1309CV

NDK212F		
Part No.	Description	Qty.
766	Bearing, Diff Right & Left Hand Cone	2
753A	Bearing, Diff Right Hand Cup	1
752B	Bearing, Diff Left Hand Cup	1
740	Bearing, Pinion Head Cone	1
742	Bearing, Pinion Head Cup	1
661	Bearing, Pinion Tail Cone	1
653	Bearing, Pinion Tail Cup	1
H414235	Bearing, Cross Shaft Right Cone	1
H414210	Bearing, Cross Shaft Right Cup	1
6580	Bearing, Cross Shaft Left Cone	1
6535W	Bearing, Cross Shaft Left Cup	1
7213BG	Bearing, Power Divider ACBB	2
BL212	Bearing, Output Shaft DGBB	1
88AX458	Seal, Input Shaft	1
CR31173	Seal, Output Shaft	1
OR247	O-Ring, Power Divider	1
OR272	O-Ring, Power Divider	1
Gasket Kit	Gasket Kit	1
Copper Washer	Copper Washer	2
TL-0.5ML	Threadlocker	1
SEALANT	RTV Silicone	1

NDK212F-V100		
Part No.	Description	Qty.
766	Bearing, Diff Right & Left Hand Cone	2
753A	Bearing, Diff Right Hand Cup	1
752B	Bearing, Diff Left Hand Cone	1
740	Bearing, Pinion Head Cone	1
742	Bearing, Pinion Head Cup	1
661	Bearing, Pinion Tail Cone	1
653	Bearing, Pinion Tail Cup	1
H414235	Bearing, Cross Shaft Right Cone	1
H414210	Bearing, Cross Shaft Right Cup	1
6580	Bearing, Cross Shaft Left Cone	1
6535W	Bearing, Cross Shaft Left Cup	1
7213BG	Bearing, Power Divider ACBB	2
BL212	Bearing, Output Shaft DGBB	1
88AX458	Seal, Input Shaft	1
CR31173	Seal, Output Shaft	1
OR247	O-Ring, Power Divider	1
OR272	O-Ring, Power Divider	1
Gasket Kit	Gasket Kit	1
Copper Washer	Copper Washer	2

NDK212R		
Part No.	Description	Qty.
766	Bearing, Diff Right & Left Hand Cone	2
753A	Bearing, Diff Right Hand Cup	1
752B	Bearing, Diff Left Hand Cone	1
6466	Bearing, Pinion Head Cone	1
6420	Bearing, Pinion Head Cup	1
65225	Bearing, Pinion Tail Cone	1
65500	Bearing, Pinion Tail Cup	1
H414235	Bearing, Cross Shaft Right Cone	1
H414210	Bearing, Cross Shaft Right Cup	1
6580	Bearing, Cross Shaft Left Cone	1
6535W	Bearing, Cross Shaft Left Cup	1
CR31173	Seal, Pinion	1
Gasket Kit	Gasket Kit	1
Copper Washer	Copper Washer	1
TL-0.5ML	Threadlocker	1
SEALANT	RTV Silicone	1

NDK212R-V100		
Part No.	Description	Qty.
766	Bearing, Diff Right & Left Hand Cone	2
753A	Bearing, Diff Right Hand Cup	1
752B	Bearing, Diff Left Hand Cone	1
6466	Bearing, Pinion Head Cone	1
6420	Bearing, Pinion Head Cup	1
65225	Bearing, Pinion Tail Cone	1
65500	Bearing, Pinion Tail Cup	1
H414235	Bearing, Cross Shaft Right Cone	1
H414210	Bearing, Cross Shaft Right Cup	1
6580	Bearing, Cross Shaft Left Cone	1
6535W	Bearing, Cross Shaft Left Cup	1
CR31173	Seal, Pinion	1
Gasket Kit	Gasket Kit	1
Copper Washer	Copper Washer	1

NDK214		
Part No.	Description	Qty.
JM716649	Bearing, Diff Right Hand Cone	1
JM716610	Bearing, Diff Right Hand Cup	1
JM822049	Bearing, Diff Left Hand Cone	1
JM822010	Bearing, Diff Left Hand Cup	1
72225C	Bearing, Pinion Head Cone	1
72487	Bearing, Pinion Head Cup	1
55200C	Bearing, Pinion Tail Cone	1
55437	Bearing, Pinion Tail Cup	1
WUS61308UM	Bearing, Nose CRB	1
455088V	Seal, Pinion	1
TL-0.5ML	Threadlocker	1
SEALANT	RTV Silicone	1

NDK214-V100		
Part No.	Description	Qty.
JM716649	Bearing, Diff Right Hand Cone	1
JM716610	Bearing, Diff Right Hand Cup	1
JM822049	Bearing, Diff Left Hand Cone	1
JM822010	Bearing, Diff Left Hand Cup	1
72225C	Bearing, Pinion Head Cone	1
72487	Bearing, Pinion Head Cup	1
55200C	Bearing, Pinion Tail Cone	1
55437	Bearing, Pinion Tail Cup	1
WUS61308UM	Bearing, Nose CRB	1
455088V	Seal, Pinion	1

NDK216		
Part No.	Description	Qty.
JLM714149	Bearing, Diff Right Hand Cone	1
JLM714110	Bearing, Diff Right Hand Cup	1
42381	Bearing, Diff Left Hand Cone	1
42584	Bearing, Diff Left Hand Cup	1
55200C	Bearing, Pinion Head Cone	1
55437	Bearing, Pinion Head Cup	1
M804049	Bearing, Pinion Tail Cone	1
M804010	Bearing, Pinion Tail Cup	1
RU1570UM	Bearing, Pinion Nose CRB	1
SLS-1807	Seal, Pinion Shaft	1
TL-0.5ML	Threadlocker	1
SEALANT	RTV Silicone	1

NDK216-V100		
Part No.	Description	Qty.
JLM714149	Bearing, Diff Right Hand Cone	1
JLM714110	Bearing, Diff Right Hand Cup	1
42381	Bearing, Diff Left Hand Cone	1
42584	Bearing, Diff Left Hand Cup	1
55200C	Bearing, Pinion Head Cone	1
55437	Bearing, Pinion Head Cup	1
M804049	Bearing, Pinion Tail Cone	1
M804010	Bearing, Pinion Tail Cup	1
RU1570UM	Bearing, Pinion Nose CRB	1
SLS-1807	Seal, Pinion Shaft	1



NDK217F		
Part No.	Description	Qty.
JM716649	Bearing, Diff Right & Left Cone	2
JM716610	Bearing, Diff Right & Left Cup	2
H715334	Bearing, Pinion Head Cone	1
H715311	Bearing, Pinion Head Cup	1
72212C	Bearing, Pinion Tail Cone	1
72487	Bearing, Pinion Tail Cup	1
JM511946	Bearing, Input Shaft Front Cone	1
JM511910	Bearing, Input Shaft Front Cup	1
JLM710949C	Bearing, Input Shaft Rear Cone	1
JLM710910	Bearing, Input Shaft Rear Cup	1
LM104949	Bearing, Output Shaft Cone	1
JLM104910	Bearing, Output Shaft Cup	1
SLS-1667	Seal, Input & Thrushaft	2
SLS-1668	O-Ring	2
TL-0.5ML	Threadlocker	1
SEALANT	RTV Silicone	1

NDK217F-V100		
Part No.	Description	Qty.
JM716649	Bearing, Diff Right & Left Cone	2
JM716610	Bearing, Diff Right & Left Cup	2
H715334	Bearing, Pinion Head Cone	1
H715311	Bearing, Pinion Head Cup	1
72212C	Bearing, Pinion Tail Cone	1
72487	Bearing, Pinion Tail Cup	1
JM511946	Bearing, Input Shaft Front Cone	1
JM511910	Bearing, Input Shaft Front Cup	1
JLM710949C	Bearing, Input Shaft Rear Cone	1
JLM710910	Bearing, Input Shaft Rear Cup	1
LM104949	Bearing, Output Shaft Cone	1
JLM104910	Bearing, Output Shaft Cup	1
SLS-1667	Seal, Input & Thrushaft	2
SLS-1668	O-Ring	2

NDK217R		
Part No.	Description	Qty.
JM716649	Bearing, Diff Right Hand Cone	1
JM716610	Bearing, Diff Right Hand Cup	1
JM716649	Bearing, Diff Left Hand Cone	1
JM716610	Bearing, Diff Left Hand Cup	1
72212C	Bearing, Pinion Head Cone	1
72487	Bearing, Pinion Head Cup	1
55206C	Bearing, Pinion Tail Cone	1
55437	Bearing, Pinion Tail Cup	1
RU1570UM	Bearing, Pinion Nose	1
A11205Z2730-NTN	Seal Pinion	1
TL-0.5ML	Threadlocker	1
SEALANT	RTV Silicone	1

NDK217R-V100		
Part No.	Description	Qty.
JM716649	Bearing, Diff Right Hand Cone	1
JM716610	Bearing, Diff Right Hand Cup	1
JM716649	Bearing, Diff Left Hand Cone	1
JM716610	Bearing, Diff Left Hand Cup	1
72212C	Bearing, Pinion Head Cone	1
72487	Bearing, Pinion Head Cup	1
55206C	Bearing, Pinion Tail Cone	1
55437	Bearing, Pinion Tail Cup	1
RU1570UM	Bearing, Pinion Nose	1
A11205Z2730-NTN	Seal Pinion	1

NDK218		
Part No.	Description	Qty.
34306	Bearing, Diff Right Hand Cone	1
34478	Bearing, Diff Right Hand Cup	1
3994	Bearing, Diff Left Hand Cone	1
JM511910	Bearing, Diff Left Hand Cup	1
55200C	Bearing, Pinion Head Cone	1
55437	Bearing, Pinion Head Cup	1
HM804846	Bearing, Pinion Tail Cone	1
HM804810	Bearing, Pinion Tail Cup	1
MUB1305UDM	Bearing, Pinion Nose CRB	1
SLS-1807	Seal, Pinion	1
TL-0.5ML	Threadlocker	1
SEALANT	RTV Silicone	1

NDK218-V100		
Part No.	Description	Qty.
34306	Bearing, Diff Right Hand Cone	1
34478	Bearing, Diff Right Hand Cup	1
3994	Bearing, Diff Left Hand Cone	1
JM511910	Bearing, Diff Left Hand Cup	1
55200C	Bearing, Pinion Head Cone	1
55437	Bearing, Pinion Tail Cone	1
HM804846	Bearing, Pinion Tail Cone	1
HM804810	Bearing, Pinion Tail Cup	1
MUB1305UDM	Bearing, Pinion Nose CRB	1
SLS-1807	Seal, Pinion	1

NDK219R		
Part No.	Description	Qty.
42381	Bearing, Diff Right Hand Cone	1
42584	Bearing, Diff Right Hand Cup	1
68462*	Bearing, Diff Left Hand Cone	1
68712	Bearing, Diff Left Hand Cup	1
78215C	Bearing, Pinion Head Cone	1
78551	Bearing, Pinion Head Cup	1
72212C	Bearing, Pinion Tail Cone	1
72487	Bearing, Pinion Tail Cup	1
WUS61308UM	Bearing, Pinion Nose CRB	1
119432	Seal, Pinion	1
TL-0.5ML	Threadlocker	1
SEALANT	RTV Silicone	1

\*FOR DIFFERENTIALS CONTAINING SUPPORT CASE 27950, END USER WILL NEED TO PURCHASE A 68540 TO USE IN PLACE OF 68462

NDK219R-V100		
Part No.	Description	Qty.
42381	Bearing, Diff Right Hand Cone	1
42584	Bearing, Diff Right Hand Cup	1
68462*	Bearing, Diff Left Hand Cone	1
68712	Bearing, Diff Left Hand Cup	1
78215C	Bearing, Pinion Head Cone	1
78551	Bearing, Pinion Head Cup	1
72212C	Bearing, Pinion Tail Cone	1
72487	Bearing, Pinion Tail Cup	1
WUS61308UM	Bearing, Pinion Nose CRB	1
119432	Seal, Pinion	1

\*FOR DIFFERENTIALS CONTAINING SUPPORT CASE 27950, END USER WILL NEED TO PURCHASE A 68540 TO USE IN PLACE OF 68462

NDK220F		
Part No.	Description	Qty.
68450	Bearing, Diff Right Hand Cone	1
68712	Bearing, Diff Right Hand Cup	1
42381	Bearing, Diff Left Hand Cone	1
42584	Bearing, Diff Left Hand Cup	1
72212C	Bearing, Pinion Head & Pinion Tail Cone	2
72487	Bearing, Pinion Head & Pinion Tail Cup	2
WUS61308UM	Bearing, Pinion Nose CRB	1
MU1309CBVV1 (Inner Ring)*	Bearing, Pinon Forward CRB-IR	1
MU1309CBVV1 (Outer Ring)*	Bearing, Pinon Forward CRB-OR	1
JM511946	Bearing, Input Shaft Front Cone	1
JM811910	Bearing, Input Shaft Front Cup	1
JH211749	Bearing, Input Shaft Rear Cone	1
JH211710	Bearing, Input Shaft Rear Cup	1
MA1211UBVV1	Bearing, Output Shaft CRB	1
SLS-1772	Seal, Input Shaft	1
SLS-1786	Seal, Thrushaft	1
TL-0.5ML	Threadlocker	1
SEALANT	RTV Silicone	1

\*LINE ITEMS WITH "\*" COMBINE INTO INDUSTRY PART NUMBER MU1309CBVV1

NDK220F-V100		
Part No.	Description	Qty.
68450	Bearing, Diff Right Hand Cone	1
68712	Bearing, Diff Right Hand Cup	1
42381	Bearing, Diff Left Hand Cone	1
42584	Bearing, Diff Left Hand Cup	1
72212C	Bearing, Pinion Head & Pinion Tail Cone	2
72487	Bearing, Pinion Head & Pinion Tail Cup	2
WUS61308UM	Bearing, Pinion Nose CRB	1
MU1309CBVV1 (Inner Ring)*	Bearing, Pinon Forward CRB-IR	1
MU1309CBVV1 (Outer Ring)*	Bearing, Pinon Forward CRB-OR	1
JM511946	Bearing, Input Shaft Front Cone	1
JM811910	Bearing, Input Shaft Front Cup	1
JH211749	Bearing, Input Shaft Rear Cone	1
JH211710	Bearing, Input Shaft Rear Cup	1
MA1211UBVV1	Bearing, Output Shaft CRB	1
SLS-1772	Seal, Input Shaft	1
SLS-1786	Seal, Thrushaft	1

\*LINE ITEMS WITH "\*" COMBINE INTO INDUSTRY PART NUMBER MU1309CBVV1

NDK220FA		
Part No.	Description	Qty.
68462	Bearing, Diff Right Hand Cone	1
68712	Bearing, Diff Right Hand Cup	1
42381	Bearing, Diff Left Hand Cone	1
42584	Bearing, Diff Left Hand Cup	1
72212C	Bearing, Pinion Head & Pinion Tail Cone	2
72487	Bearing, Pinion Head & Pinion Tail Cup	2
WUS61308UM	Bearing, Pinion Nose CRB	1
MU1309CBVV1 (Inner Ring)*	Bearing, Pinon Forward CRB-IR	1
MU1309CBVV1 (Outer Ring)*	Bearing, Pinon Forward CRB-OR	1
JM511946	Bearing, Input Shaft Front Cone	1
JM811910	Bearing, Input Shaft Front Cup	1
JH211749	Bearing, Input Shaft Rear Cone	1
JH211710	Bearing, Input Shaft Rear Cup	1
MA1211UBVV1	Bearing, Output Shaft CRB	1
SLS-1772	Seal, Input Shaft	1
SLS-1786	Seal, Thrushaft	1
TL-0.5ML	Threadlocker	1
SEALANT	RTV Silicone	1

\* LINE ITEMS WITH "\*" COMBINE INTO INDUSTRY PART NUMBER MU1309CBVV1

NDK220FA-V100		
Part No.	Description	Qty.
68462	Bearing, Diff Right Hand Cone	1
68712	Bearing, Diff Right Hand Cup	1
42381	Bearing, Diff Left Hand Cone	1
42584	Bearing, Diff Left Hand Cup	1
72212C	Bearing, Pinion Head & Pinion Tail Cone	2
72487	Bearing, Pinion Head & Pinion Tail Cup	2
WUS61308UM	Bearing, Pinion Nose CRB	1
MU1309CBVV1 (Inner Ring)*	Bearing, Pinon Forward CRB-IR	1
MU1309CBVV1 (Outer Ring)*	Bearing, Pinon Forward CRB-OR	1
JM511946	Bearing, Input Shaft Front Cone	1
JM811910	Bearing, Input Shaft Front Cup	1
JH211749	Bearing, Input Shaft Rear Cone	1
JH211710	Bearing, Input Shaft Rear Cup	1
MA1211UBVV1	Bearing, Output Shaft CRB	1
SLS-1772	Seal, Input Shaft	1
SLS-1786	Seal, Thrushaft	1

\* LINE ITEMS WITH "\*" COMBINE INTO INDUSTRY PART NUMBER MU1309CBVV1

NDK222F		
Part No.	Description	Qty.
567	Bearing, Diff Right Hand Cone	1
563	Bearing, Diff Right Hand Cup	1
497	Bearing, Diff Left Hand Cone	1
493	Bearing, Diff Left Hand Cup	1
72218C	Bearing, Pinion Head Cone	1
72487	Bearing, Pinion Head Cup	1
HM807049	Bearing, Pinion Tail Cone	1
HM807010	Bearing, Pinion Tail Cup	1
MUS7307UBM	Bearing, Pinion Nose CRB	1
3979	Bearing, Input Shaft Cone	1
JM511910	Bearing, Input Shaft Cup	1
29675	Bearing, Output Shaft Front Cone	1
29620	Bearing, Output Shaft Front Cup	1
MA1209V1	Bearing, Output Shaft Rear Cone CRB	1
M1209TV	Bearing, Output Shaft Rear Cup CRB	1
127719	Seal, Input Shaft	1
127720	Seal, Thrushaft	1
TL-0.5ML	Threadlocker	1
SEALANT	RTV Silicone	1

NDK222F-V100		
Part No.	Description	Qty.
567	Bearing, Diff Right Hand Cone	1
563	Bearing, Diff Right Hand Cup	1
497	Bearing, Diff Left Hand Cone	1
493	Bearing, Diff Left Hand Cup	1
72218C	Bearing, Pinion Head Cone	1
72487	Bearing, Pinion Head Cup	1
HM807049	Bearing, Pinion Tail Cone	1
HM807010	Bearing, Pinion Tail Cup	1
MUS7307UBM	Bearing, Pinion Nose CRB	1
3979	Bearing, Input Shaft Cone	1
JM511910	Bearing, Input Shaft Cup	1
29675	Bearing, Output Shaft Front Cone	1
29620	Bearing, Output Shaft Front Cup	1
MA1209V1	Bearing, Output Shaft Rear Cone CRB	1
M1209TV	Bearing, Output Shaft Rear Cup CRB	1
127719	Seal, Input Shaft	1
127720	Seal, Thrushaft	1

NDK222R		
Part No.	Description	Qty.
567	Bearing, Diff Right Hand Cone	1
563	Bearing, Diff Right Hand Cup	1
497	Bearing, Diff Left Hand Cone	1
493	Bearing, Diff Left Hand Cup	1
72200C	Bearing, Pinion Head Cone	1
72487	Bearing, Pinion Head Cup	1
55200C	Bearing, Pinion Tail Cone	1
55437	Bearing, Pinion Tail Cup	1
MUS7307UBM	Bearing, Pinion Nose CRB	1
127721	Seal, Input Shaft	1
TL-0.5ML	Threadlocker	1
SEALANT	RTV Silicone	1

NDK222R-V100		
Part No.	Description	Qty.
567	Bearing, Diff Right Hand Cone	1
563	Bearing, Diff Right Hand Cup	1
497	Bearing, Diff Left Hand Cone	1
493	Bearing, Diff Left Hand Cup	1
72200C	Bearing, Pinion Head Cone	1
72487	Bearing, Pinion Head Cup	1
55200C	Bearing, Pinion Tail Cone	1
55437	Bearing, Pinion Tail Cup	1
MUS7307UBM	Bearing, Pinion Nose CRB	1
127721	Seal, Input Shaft	1

NDK223F		
Part No.	Description	Qty.
495	Bearing, Diff Right & Left Hand Cone	2
493	Bearing, Diff Right & Left Hand Cup	2
72225C	Bearing, Pinion Head & Tail Cone	2
72487	Bearing, Pinion Head & Tail Cup	2
RU1570UM	Bearing, Pinion Nose CRB	1
HM807049	Bearing, Input Shaft Cone	1
HM807010	Bearing, Input Shaft Cup	1
B-3624	Bearing, Input Gear NRB	1
JLM710949	Bearing, Internal Axle Cone	1
JLM710910	Bearing, Internal Axle Cup	1
A-1400	Bearing, Input Shaft TRB	1
OR-230 NBR70	O-Ring	1
401HH103	Seal, Input Shaft	1
401HH104	Seal, Output Shaft	1
TL-0.5ML	Threadlocker	1
SEALANT	RTV Silicone	1

NDK223F-V100		
Part No.	Description	Qty.
495	Bearing, Diff Right & Left Hand Cone	2
493	Bearing, Diff Right & Left Hand Cup	2
72225C	Bearing, Pinion Head & Tail Cone	2
72487	Bearing, Pinion Head & Tail Cup	2
RU1570UM	Bearing, Pinion Nose CRB	1
HM807049	Bearing, Input Shaft Cone	1
HM807010	Bearing, Input Shaft Cup	1
B-3624	Bearing, Input Gear NRB	1
JLM710949	Bearing, Internal Axle Cone	1
JLM710910	Bearing, Internal Axle Cup	1
A-1400	Bearing, Input Shaft TRB	1
OR-230 NBR70	O-Ring	1
401HH103	Seal, Input Shaft	1
401HH104	Seal, Output Shaft	1

NDK223R		
Part No.	Description	Qty.
495	Bearing, Diff Right & Left Hand Cone	2
493	Bearing, Diff Right & Left Hand Cup	2
72225C	Bearing, Pinion Head & Tail Cone	2
72487	Bearing, Pinion Head & Tail Cup	2
RU1570UM	Bearing, Pinion Nose CRB	1
401HH102	Seal, Input Shaft	1
TL-0.5ML	Threadlocker	1
SEALANT	RTV Silicone	1

NDK223R-V100		
Part No.	Description	Qty.
495	Bearing, Diff Right & Left Hand Cone	2
493	Bearing, Diff Right & Left Hand Cup	2
72225C	Bearing, Pinion Head & Tail Cone	2
72487	Bearing, Pinion Head & Tail Cup	2
RU1570UM	Bearing, Pinion Nose CRB	1
401HH102	Seal, Input Shaft	1

NDK401		
Part No.	Description	Qty.
JM822049	Bearing, Diff Right Hand Cone	1
JM822010	Bearing, Diff Right Hand Cup	1
32024X	Bearing, Diff Left Hand TRB	1
H914841	Bearing, Pinion Head Cone	1
H914811	Bearing, Pinion Head Cup	1
HM813841	Bearing, Pinion Tail Cone	1
HM813810	Bearing, Pinion Tail Cup	1
MU1309UM	Bearing, Pinion Nose CRB	1
SLS-1774	Seal, Pinion	1
TL-0.5ML	Threadlocker	1
SEALANT	RTV Silicone	1

NDK401-V100		
Part No.	Description	Qty.
JM822049	Bearing, Diff Right Hand Cone	1
JM822010	Bearing, Diff Right Hand Cup	1
32024X	Bearing, Diff Left Hand TRB	1
H914841	Bearing, Pinion Head Cone	1
H914811	Bearing, Pinion Head Cup	1
HM813841	Bearing, Pinion Tail Cone	1
HM813810	Bearing, Pinion Tail Cup	1
MU1309UM	Bearing, Pinion Nose CRB	1
SLS-1774	Seal, Pinion	1

NDK402		
Part No.	Description	Qty.
JM822049	Bearing, Diff Right Hand Cone	1
JM822010	Bearing, Diff Right Hand Cup	1
56425	Bearing, Diff Left Hand Cone	1
56650	Bearing, Diff Left Hand Cup	1
H914841	Bearing, Pinion Head Cone	1
H914811	Bearing, Pinion Head Cup	1
HM713841	Bearing, Pinion Tail Cone	1
HM813810	Bearing, Pinion Tail Cup	1
MU1309UM	Bearing, Pinion Nose CRB	1
SLS-1774	Seal, Pinion	1
TL-0.5ML	Threadlocker	1
SEALANT	RTV Silicone	1

NDK402-V100		
Part No.	Description	Qty.
JM822049	Bearing, Diff Right Hand Cone	1
JM822010	Bearing, Diff Right Hand Cup	1
56425	Bearing, Diff Left Hand Cone	1
56650	Bearing, Diff Left Hand Cup	1
H914841	Bearing, Pinion Head Cone	1
H914811	Bearing, Pinion Head Cup	1
HM713841	Bearing, Pinion Tail Cone	1
HM813810	Bearing, Pinion Tail Cup	1
MU1309UM	Bearing, Pinion Nose CRB	1
SLS-1774	Seal, Pinion	1

NDK403		
Part No.	Description	Qty.
497	Bearing, Diff Right Hand Cone	1
493	Bearing, Diff Right Hand Cup	1
56425	Bearing, Diff Left Hand Cone	1
56650	Bearing, Diff Left Hand Cup	1
72200C	Bearing, Pinion Head Cone	1
72487	Bearing, Pinion Head Cup	1
55200C	Bearing, Pinion Tail Cone	1
55437	Bearing, Pinion Tail Cup	1
WUB61307UM	Bearing, Pinion Nose, CRB	1
127721	Seal, Pinion	1
TL-0.5ML	Threadlocker	1
SEALANT	RTV Silicone	1

NDK403-V100		
Part No.	Description	Qty.
497	Bearing, Diff Right Hand Cone	1
493	Bearing, Diff Right Hand Cup	1
56425	Bearing, Diff Left Hand Cone	1
56650	Bearing, Diff Left Hand Cup	1
72200C	Bearing, Pinion Head Cone	1
72487	Bearing, Pinion Head Cup	1
55200C	Bearing, Pinion Tail Cone	1
55437	Bearing, Pinion Tail Cup	1
WUB61307UM	Bearing, Pinion Nose, CRB	1
127721	Seal, Pinion	1

NDK404F		
Part No.	Description	Qty.
567	Bearing, Diff Right Hand Cone	1
563	Bearing, Diff Right Hand Cup	1
497	Bearing, Diff Left Hand Cone	1
493	Bearing, Diff Left Hand Cup	1
72218C	Bearing, Pinion Head Cone	1
72487	Bearing, Pinion Head Cup	1
55212C	Bearing, Pinion Tail Cone	1
55437	Bearing, Pinion Tail Cup	1
MUB1307UBM	Bearing, Pinion Nose	1
555S	Bearing, Input Shaft Cone	1
552A	Bearing, Input Shaft Cup	1
29675	Bearing, Output Shaft Inner Cone	1
29630	Bearing, Output Shaft Inner Cup	1
SLS-1699	Seal, Input Shaft	1
SLS-1702	V-Ring, Input	1
SLS-1701	Seal, Thrushaft	1
MSC-1671	RTV Silicone	1

NDK404F-V100		
Part No.	Description	Qty.
567	Bearing, Diff Right Hand Cone	1
563	Bearing, Diff Right Hand Cup	1
497	Bearing, Diff Left Hand Cone	1
493	Bearing, Diff Left Hand Cup	1
72218C	Bearing, Pinion Head Cone	1
72487	Bearing, Pinion Head Cup	1
55212C	Bearing, Pinion Tail Cone	1
55437	Bearing, Pinion Tail Cup	1
MUB1307UBM	Bearing, Pinion Nose	1
555S	Bearing, Input Shaft Cone	1
552A	Bearing, Input Shaft Cup	1
29675	Bearing, Output Shaft Inner Cone	1
29630	Bearing, Output Shaft Inner Cup	1
SLS-1699	Seal, Input Shaft	1
SLS-1702	V-Ring, Input	1

NDK404FA		
Part No.	Description	Qty.
567	Bearing, Diff Right Hand Cone	1
563	Bearing, Diff Right Hand Cup	1
497	Bearing, Diff Left Hand Cone	1
493	Bearing, Diff Left Hand Cup	1
72218C	Bearing, Pinion Head Cone	1
72487	Bearing, Pinion Head Cup	1
55212C	Bearing, Pinion Tail Cone	1
55437	Bearing, Pinion Tail Cup	1
MUB1307UBM	Bearing, Pinion Nose CRB	1
555S	Bearing, Input Shaft Cone	1
552A	Bearing, Input Shaft Cup	1
29688	Bearing, Output Shaft Cone	1
29620	Bearing, Output Shaft Cup	1
SLS-1699	Seal, Input Shaft	1
SLS-1701	Seal, Thrushaft	1
TL-0.5ML	Threadlocker	1
SEALANT	RTV Silicone	1

NDK404FA-V100		
Part No.	Description	Qty.
567	Bearing, Diff Right Hand Cone	1
563	Bearing, Diff Right Hand Cup	1
497	Bearing, Diff Left Hand Cone	1
493	Bearing, Diff Left Hand Cup	1
72218C	Bearing, Pinion Head Cone	1
72487	Bearing, Pinion Head Cup	1
55212C	Bearing, Pinion Tail Cone	1
55437	Bearing, Pinion Tail Cup	1
MUB1307UBM	Bearing, Pinion Nose CRB	1
555S	Bearing, Input Shaft Cone	1
552A	Bearing, Input Shaft Cup	1
29688	Bearing, Output Shaft Cone	1
29620	Bearing, Output Shaft Cup	1
SLS-1699	Seal, Input Shaft	1
SLS-1701	Seal, Thrushaft	1

NDK404R		
Part No.	Description	Qty.
497	Bearing, Diff Right Hand Cone	1
493	Bearing, Diff Right Hand Cup	1
567	Bearing, Diff Left Hand Cone	1
563	Bearing, Diff Left Hand Cup	1
72212C	Bearing, Pinion Head Cone	1
72487	Bearing, Pinion Head Cup	1
55200C	Bearing, Pinion Tail Cone	1
55437	Bearing, Pinion Tail Cup	1
MUB7307UBM	Bearing, Pinion Nose	1
127591-NTN	Seal Pinion	1
MSC-1671	RTV Silicone	1

NDK404R-V100		
Part No.	Description	Qty.
497	Bearing, Diff Right Hand Cone	1
493	Bearing, Diff Right Hand Cup	1
567	Bearing, Diff Left Hand Cone	1
563	Bearing, Diff Left Hand Cup	1
72212C	Bearing, Pinion Head Cone	1
72487	Bearing, Pinion Head Cup	1
55200C	Bearing, Pinion Tail Cone	1
55437	Bearing, Pinion Tail Cup	1
MUB7307UBM	Bearing, Pinion Nose	1
127591-NTN	Seal Pinion	1

NDK405F		
Part No.	Description	Qty.
NP799449	Bearing, Diff Right Hand Cone	1
NP105857	Bearing, Diff Right Hand Cup	1
42362	Bearing, Diff Left Hand Cone	1
42584	Bearing, Diff Left Hand Cup	1
72218C	Bearing, Pinion Head Cone	1
72487	Bearing, Pinion Head Cup	1
55212C	Bearing, Pinion Tail Cone	1
55437	Bearing, Pinion Tail Cup	1
MUB1307UBM	Bearing, Pinion Nose CRB	1
5555	Bearing, Input Shaft Cone	1
552A	Bearing, Input Shaft Cup	1
29675	Bearing, Output Shaft Cone	1
29620	Bearing, Output Shaft Cup	1
SLS-1699	Seal, Input Shaft	1
SLS-1702	V-Ring, Input Shaft	1
SLS-1701	Seal, Thrushaft	1
TL-0.5ML	Threadlocker	1
SEALANT	RTV Silicone	1

NDK405F-V100		
Part No.	Description	Qty.
NP799449	Bearing, Diff Right Hand Cone	1
NP105857	Bearing, Diff Right Hand Cup	1
42362	Bearing, Diff Left Hand Cone	1
42584	Bearing, Diff Left Hand Cup	1
72218C	Bearing, Pinion Head Cone	1
72487	Bearing, Pinion Head Cup	1
55212C	Bearing, Pinion Tail Cone	1
55437	Bearing, Pinion Tail Cup	1
MUB1307UBM	Bearing, Pinion Nose CRB	1
5555	Bearing, Input Shaft Cone	1
552A	Bearing, Input Shaft Cup	1
29675	Bearing, Output Shaft Cone	1
29620	Bearing, Output Shaft Cup	1
SLS-1699	Seal, Input Shaft	1
SLS-1702	V-Ring, Input Shaft	1
SLS-1701	Seal, Thrushaft	1

NDK405FA		
Part No.	Description	Qty.
567	Bearing, Diff Right Hand Cone	1
563	Bearing, Diff Right Hand Cup	1
42362	Bearing, Diff Left Hand Cone	1
42584	Bearing, Diff Left Hand Cup	1
72218C	Bearing, Pinion Head Cone	1
72487	Bearing, Pinion Head Cup	1
55212C	Bearing, Pinion Tail Cone	1
55437	Bearing, Pinion Tail Cup	1
MUB1307UBM	Bearing, Pinion Nose CRB	1
5555	Bearing, Input Shaft Cone	1
552A	Bearing, Input Shaft Cup	1
29688	Bearing, Output Shaft Cone	1
28620	Bearing, Output Shaft Cup	1
SLS-1702	V-Ring, Input Shaft	1
SLS-1699	Seal, Input Shaft	1
SLS-1701	Seal, Thrushaft	1
TL-0.5ML	Threadlocker	1
SEALANT	RTV Silicone	1

NDK405FA-V100		
Part No.	Description	Qty.
567	Bearing, Diff Right Hand Cone	1
563	Bearing, Diff Right Hand Cup	1
42362	Bearing, Diff Left Hand Cone	1
42584	Bearing, Diff Left Hand Cup	1
72218C	Bearing, Pinion Head Cone	1
72487	Bearing, Pinion Head Cup	1
55212C	Bearing, Pinion Tail Cone	1
55437	Bearing, Pinion Tail Cup	1
MUB1307UBM	Bearing, Pinion Nose CRB	1
5555	Bearing, Input Shaft Cone	1
552A	Bearing, Input Shaft Cup	1
29688	Bearing, Output Shaft Cone	1
28620	Bearing, Output Shaft Cup	1
SLS-1702	V-Ring, Input Shaft	1
SLS-1699	Seal, Input Shaft	1
SLS-1701	Seal, Thrushaft	1

NDK405R		
Part No.	Description	Qty.
42362	Bearing, Diff Right Hand Cone	1
42584	Bearing, Diff Right Hand Cup	1
567	Bearing, Diff Left Hand Cone	1
563	Bearing, Diff Left Hand Cup	1
72212C	Bearing, Pinion Head Cone	1
72487	Bearing, Pinion Head Cup	1
55200C	Bearing, Pinion Tail Cone	1
55437	Bearing, Pinion Tail Cup	1
MUB7307UBM	Bearing, Pinion Nose, CRB	1
SLS-1699	Seal, Pinion	1
TL-0.5ML	Threadlocker	1
SEALANT	RTV Silicone	1

NDK405R-V100		
Part No.	Description	Qty.
42362	Bearing, Diff Right Hand Cone	1
42584	Bearing, Diff Right Hand Cup	1
567	Bearing, Diff Left Hand Cone	1
563	Bearing, Diff Left Hand Cup	1
72212C	Bearing, Pinion Head Cone	1
72487	Bearing, Pinion Head Cup	1
55200C	Bearing, Pinion Tail Cone	1
55437	Bearing, Pinion Tail Cup	1
MUB7307UBM	Bearing, Pinion Nose, CRB	1
SLS-1699	Seal, Pinion	1

NDK406		
Part No.	Description	Qty.
598	Bearing, Diff Right Hand Cone	1
592A	Bearing, Diff Right Hand Cup	1
497	Bearing, Diff Left Hand Cone	1
493	Bearing, Diff Left Hand Cup	1
78215C	Bearing, Pinion Head Cone	1
78551	Bearing, Pinion Head Cup	1
55200C	Bearing, Pinion Tail Cone	1
55437	Bearing, Pinion Tail Cup	1
WUS61308UM	Bearing, Pinion Nose CRB	1
SLS-1696	Seal, Pinion Shaft	1
TL-0.5ML	Threadlocker	1
SEALANT	RTV Silicone	1

NDK406-V100		
Part No.	Description	Qty.
598	Bearing, Diff Right Hand Cone	1
592A	Bearing, Diff Right Hand Cup	1
497	Bearing, Diff Left Hand Cone	1
493	Bearing, Diff Left Hand Cup	1
78215C	Bearing, Pinion Head Cone	1
78551	Bearing, Pinion Head Cup	1
55200C	Bearing, Pinion Tail Cone	1
55437	Bearing, Pinion Tail Cup	1
WUS61308UM	Bearing, Pinion Nose CRB	1
SLS-1696	Seal, Pinion Shaft	1

NDK410		
Part No.	Description	Qty.
497	Bearing, Diff Right Hand Cone	1
493	Bearing, Diff Right Hand Cup	1
598	Bearing, Diff Left Hand Cone	1
592A	Bearing, Diff Left Hand Cup	1
H914841	Bearing, Pinion Head Cone	1
H914811	Bearing, Pinion Head Cup	1
HM813841	Bearing, Pinion Tail Cone	1
HM813810	Bearing, Pinion Tail Cup	1
WUB61308UM	Bearing, Pinion Nose CRB	1
SLS-1774	Seal, Pinion	1
TL-0.5ML	Threadlocker	1
SEALANT	RTV Silicone	1

NDK410-V100		
Part No.	Description	Qty.
497	Bearing, Diff Right Hand Cone	1
493	Bearing, Diff Right Hand Cup	1
598	Bearing, Diff Left Hand Cone	1
592A	Bearing, Diff Left Hand Cup	1
H914841	Bearing, Pinion Head Cone	1
H914811	Bearing, Pinion Head Cup	1
HM813841	Bearing, Pinion Tail Cone	1
HM813810	Bearing, Pinion Tail Cup	1
WUB61308UM	Bearing, Pinion Nose CRB	1
SLS-1774	Seal, Pinion	1

NDK412		
Part No.	Description	Qty.
497	Bearing, Diff Right Hand Cone	1
493	Bearing, Diff Right Hand Cup	1
567	Bearing, Diff Left Hand Cone	1
563	Bearing, Diff Left Hand Cup	1
72200C	Bearing, Pinion Head Cone	1
72487	Bearing, Pinion Head Cup	1
55200C	Bearing, Pinion Tail Cone	1
55437	Bearing, Pinion Tail Cup	1
MUB1307UBM	Bearing, Pinion Nose CRB	1
127721	Seal, Pinion	1
TL-0.5ML	Threadlocker	1
SEALANT	RTV Silicone	1

NDK412-V100		
Part No.	Description	Qty.
497	Bearing, Diff Right Hand Cone	1
493	Bearing, Diff Right Hand Cup	1
567	Bearing, Diff Left Hand Cone	1
563	Bearing, Diff Left Hand Cup	1
72200C	Bearing, Pinion Head Cone	1
72487	Bearing, Pinion Head Cup	1
55200C	Bearing, Pinion Tail Cone	1
55437	Bearing, Pinion Tail Cup	1
MUB1307UBM	Bearing, Pinion Nose CRB	1
127721	Seal, Pinion	1



NDK413		
Part No.	Description	Qty.
42381	Bearing, Diff Right Hand Cone	1
42584	Bearing, Diff Right Hand Cup	1
68462	Bearing, Diff Left Hand Cone	1
68712	Bearing, Diff Left Hand Cup	1
78215C	Bearing, Pinion Head Cone	1
78551	Bearing, Pinion Head Cup	1
72212C	Bearing, Pinion Tail Cone	1
72487	Bearing, Pinion Tail Cup	1
WU561308UM	Bearing, Pinion Nose CRB	1
SLS-1774	Seal, Pinion	1
TL-0.5ML	Threadlocker	1
SEALANT	RTV Silicone	1

NDK413-V100		
Part No.	Description	Qty.
42381	Bearing, Diff Right Hand Cone	1
42584	Bearing, Diff Right Hand Cup	1
68462	Bearing, Diff Left Hand Cone	1
68712	Bearing, Diff Left Hand Cup	1
78215C	Bearing, Pinion Head Cone	1
78551	Bearing, Pinion Head Cup	1
72212C	Bearing, Pinion Tail Cone	1
72487	Bearing, Pinion Tail Cup	1
WU561308UM	Bearing, Pinion Nose CRB	1
SLS-1774	Seal, Pinion	1

NDK414		
Part No.	Description	Qty.
3984	Bearing, Diff Right & Left Hand Cone	2
3920	Bearing, Diff Right & Left Hand Cup	2
55175C	Bearing, Pinion Head Cone	1
55437	Bearing, Pinion Head Cup	1
72225C	Bearing, Pinion Tail Cone	1
72487	Bearing, Pinion Tail Cup	1
SLS-1878	Seal, Pinion	1
TL-0.5ML	Threadlocker	1
SEALANT	RTV Silicone	1

NDK414-V100		
Part No.	Description	Qty.
3984	Bearing, Diff Right & Left Hand Cone	2
3920	Bearing, Diff Right & Left Hand Cup	2
55175C	Bearing, Pinion Head Cone	1
55437	Bearing, Pinion Head Cup	1
72225C	Bearing, Pinion Tail Cone	1
72487	Bearing, Pinion Tail Cup	1
SLS-1878	Seal, Pinion	1

NDK415		
Part No.	Description	Qty.
42381	Bearing, Diff Right Hand Cone	1
42584	Bearing, Diff Right Hand Cup	1
665	Bearing, Diff Left Hand Cone	1
653	Bearing, Diff Left Hand Cup	1
72212C	Bearing, Pinion Head & Tail Cone	2
72487	Bearing, Pinion Head & Tail Cup	2
MU1309UMV1	Bearing, Pinion Nose CRB	1
SLS-1785	Seal, Input Shaft	1
TL-0.5ML	Threadlocker	1
SEALANT	RTV Silicone	1

NDK415-V100		
Part No.	Description	Qty.
42381	Bearing, Diff Right Hand Cone	1
42584	Bearing, Diff Right Hand Cup	1
665	Bearing, Diff Left Hand Cone	1
653	Bearing, Diff Left Hand Cup	1
72212C	Bearing, Pinion Head & Tail Cone	2
72487	Bearing, Pinion Head & Tail Cup	2
MU1309UMV1	Bearing, Pinion Nose CRB	1
SLS-1785	Seal, Input Shaft	1

NDK416		
Part No.	Description	Qty.
56425	Bearing, Diff Right & Left Hand Cone	2
56650	Bearing, Diff Right & Left Hand Cup	2
9185	Bearing, Pinion Head Cone	1
9121	Bearing, Pinion Head Cup	1
H715343	Bearing, Pinion Tail Cone	1
H715311	Bearing, Pinion Tail Cup	1
RU9008UM	Bearing, Pinion Nose CRB	1
SLS-1832	Seal, Pinion	1
TL-0.5ML	Threadlocker	1
SEALANT	RTV Silicone	1

NDK416-V100		
Part No.	Description	Qty.
56425	Bearing, Diff Right & Left Hand Cone	2
56650	Bearing, Diff Right & Left Hand Cup	2
9185	Bearing, Pinion Head Cone	1
9121	Bearing, Pinion Head Cup	1
H715343	Bearing, Pinion Tail Cone	1
H715311	Bearing, Pinion Tail Cup	1
RU9008UM	Bearing, Pinion Nose CRB	1
SLS-1832	Seal, Pinion	1

NDK418		
Part No.	Description	Qty.
665	Bearing, Diff Right Hand Cone	1
653	Bearing, Diff Right Hand Cup	1
42381	Bearing, Diff Left Hand Cone	1
42584	Bearing, Diff Left Hand Cup	1
72212C	Bearing, Pinion Head & Pinion Tail Cone	2
72487	Bearing, Pinion Head & Pinion Tail Cup	2
WUS61308UM	Bearing, Pinion Nose CRB	1
MU1309CBVV1 (Inner Ring)*	Bearing, Output Shaft Rear CRB-IR	1
MU1309CBVV1 (Outer Ring)*	Bearing, Output Shaft Rear CRB-OR	1
JH211749	Bearing, Input Shaft Front Cone	1
JH211710	Bearing, Input Shaft Front Cup	1
JM511946	Bearing, Input Shaft Rear Cone	1
JM511910	Bearing, Input Shaft Rear Cup	1
3979	Bearing, Front Output Shaft Front Cone	1
3920	Bearing, Front Output Shaft Front Cup	1
3872	Bearing, Front Output Shaft Rear Cone	1
3820	Bearing, Front Output Shaft Rear Cup	1
SLS-1780	Seal, Input Shaft	1
SLS-1781	Seal, Thrushaft	1
TL-0.5ML	Threadlocker	1
SEALANT	RTV Silicone	1

NDK418-V100		
Part No.	Description	Qty.
665	Bearing, Diff Right Hand Cone	1
653	Bearing, Diff Right Hand Cup	1
42381	Bearing, Diff Left Hand Cone	1
42584	Bearing, Diff Left Hand Cup	1
72212C	Bearing, Pinion Head & Pinion Tail Cone	2
72487	Bearing, Pinion Head & Pinion Tail Cup	2
WUS61308UM	Bearing, Pinion Nose CRB	1
MU1309CBVV1 (Inner Ring)*	Bearing, Output Shaft Rear CRB-IR	1
MU1309CBVV1 (Outer Ring)*	Bearing, Output Shaft Rear CRB-OR	1
JH211749	Bearing, Input Shaft Front Cone	1
JH211710	Bearing, Input Shaft Front Cup	1
JM511946	Bearing, Input Shaft Rear Cone	1
JM511910	Bearing, Input Shaft Rear Cup	1
3979	Bearing, Front Output Shaft Front Cone	1
3920	Bearing, Front Output Shaft Front Cup	1
3872	Bearing, Front Output Shaft Rear Cone	1
3820	Bearing, Front Output Shaft Rear Cup	1
SLS-1780	Seal, Input Shaft	1
SLS-1781	Seal, Thrushaft	1

\* LINE ITEMS WITH "\*" COMBINE INTO INDUSTRY PART NUMBER MU1309CBVV1

\* LINE ITEMS WITH "\*" COMBINE INTO INDUSTRY PART NUMBER MU1309CBVV1

NDK419		
Part No.	Description	Qty.
497	Bearing, Diff Right Hand Cone	1
493	Bearing, Diff Right Hand Cup	1
56425	Bearing, Diff Left Hand Cone	1
56650	Bearing, Diff Left Hand Cup	1
72218C	Bearing, Pinion Head Cone	1
72487	Bearing, Pinion Head Cup	1
HM807049	Bearing, Pinion Tail Cone	1
HM807010	Bearing, Pinion Tail Cup	1
WUB61307UM	Bearing, Pinion Nose CRB	1
MUF1208CBXV1 (Inner Ring)*	Bearing, Outer Pinion Support CRB-IR	1
MUF1208CBXV1 (Outer Ring)*	Bearing, Outer Pinion Support CRB-OR	1
3979	Bearing, Input Shaft Front & Input Shaft Rear Cone	2
JM511910	Bearing, Input Shaft Front Cup	1
3920	Bearing, Input Shaft Rear Cone	1
3780	Bearing, Front Output Shaft Front Bearing Cone	1
3720	Bearing, Front Output Shaft Front Bearing Cup	1
LM501349	Bearing, Front Output Shaft Rear Bearing Cone	1
LM501310	Bearing, Front Output Shaft Rear Bearing Cup	1
SLS-1781	Seal, Input Shaft	1
SLS-1785	Seal, Front Thrushaft	1
TL-0.5ML	Threadlocker	1
SEALANT	RTV Silicone	1

\*LINE ITEMS WITH "\*" COMBINE INTO INDUSTRY PART NUMBER MUF1208CBXV1

NDK419-V100		
Part No.	Description	Qty.
497	Bearing, Diff Right Hand Cone	1
493	Bearing, Diff Right Hand Cup	1
56425	Bearing, Diff Left Hand Cone	1
56650	Bearing, Diff Left Hand Cup	1
72218C	Bearing, Pinion Head Cone	1
72487	Bearing, Pinion Head Cup	1
HM807049	Bearing, Pinion Tail Cone	1
HM807010	Bearing, Pinion Tail Cup	1
WUB61307UM	Bearing, Pinion Nose CRB	1
MUF1208CBXV1 (Inner Ring)*	Bearing, Outer Pinion Support CRB-IR	1
MUF1208CBXV1 (Outer Ring)*	Bearing, Outer Pinion Support CRB-OR	1
3979	Bearing, Input Shaft Front & Input Shaft Rear Cone	2
JM511910	Bearing, Input Shaft Front Cup	1
3920	Bearing, Input Shaft Rear Cone	1
3780	Bearing, Front Output Shaft Front Bearing Cone	1
3720	Bearing, Front Output Shaft Front Bearing Cup	1
LM501349	Bearing, Front Output Shaft Rear Bearing Cone	1
LM501310	Bearing, Front Output Shaft Rear Bearing Cup	1
SLS-1781	Seal, Input Shaft	1
SLS-1785	Seal, Front Thrushaft	1

\*LINE ITEMS WITH "\*" COMBINE INTO INDUSTRY PART NUMBER MUF1208CBXV1

NDK420		
Part No.	Description	Qty.
42381	Bearing, Diff Right Hand Cone	1
42584	Bearing, Diff Right Hand Cup	1
68462	Bearing, Diff Left Hand Cone	1
68712	Bearing, Diff Left Hand Cup	1
72212C	Bearing, Pinion Head & Tail Cone	2
72487	Bearing, Pinion Head & Tail Cup	2
WUS61308UM	Bearing, Pinion Nose CRB	1
MU1309CB	Bearing, Outer Pinion Support CRB	1
JH211749	Bearing, Input Shaft Front Cone	1
JH211710	Bearing, Input Shaft Front Cup	1
JM511946	Bearing, Input Shaft Rear Cone	1
JM511910	Bearing, Input Shaft Rear Cup	1
3979	Bearing, Output Shaft Front Cone	1
3920	Bearing, Output Shaft Front Cup	1
3872	Bearing, Output Shaft Rear Cone	1
3820	Bearing, Output Shaft Rear Cup	1
119430	Seal, Input Shaft	1
119429	Seal, Front Thrushaft	1
TL-0.5ML	Threadlocker	1
SEALANT	RTV Silicone	1

NDK420-V100		
Part No.	Description	Qty.
42381	Bearing, Diff Right Hand Cone	1
42584	Bearing, Diff Right Hand Cup	1
68462	Bearing, Diff Left Hand Cone	1
68712	Bearing, Diff Left Hand Cup	1
72212C	Bearing, Pinion Head & Tail Cone	2
72487	Bearing, Pinion Head & Tail Cup	2
WUS61308UM	Bearing, Pinion Nose CRB	1
MU1309CB	Bearing, Outer Pinion Support CRB	1
JH211749	Bearing, Input Shaft Front Cone	1
JH211710	Bearing, Input Shaft Front Cup	1
JM511946	Bearing, Input Shaft Rear Cone	1
JM511910	Bearing, Input Shaft Rear Cup	1
3979	Bearing, Output Shaft Front Cone	1
3920	Bearing, Output Shaft Front Cup	1
3872	Bearing, Output Shaft Rear Cone	1
3820	Bearing, Output Shaft Rear Cup	1
119430	Seal, Input Shaft	1
119429	Seal, Front Thrushaft	1

NDK421		
Part No.	Description	Qty.
42346	Bearing, Diff Right Hand Cone	1
42584	Bearing, Diff Right Hand Cup	1
68462	Bearing, Diff Left Hand Cone	1
68712	Bearing, Diff Left Hand Cup	1
72212C	Bearing, Pinion Head & Pinion Tail Cone	2
72487	Bearing, Pinion Head & Pinion Tail Cup	2
WUS61308UM	Bearing, Pinion Nose CRB	1
MU1309CBVV1 (Inner Ring)*	Bearing, Output Shaft Rear CRB-IR	1
MU1309CBVV1 (Outer Ring)*	Bearing, Output Shaft Rear CRB-OR	1
JH211749	Bearing, Input Shaft Front Cone	1
JH211710	Bearing, Input Shaft Front Cup	1
JM511946	Bearing, Input Shaft Rear Cone	1
JM511910	Bearing, Input Shaft Rear Cup	1
3979	Bearing, Front Output Shaft Front Cone	1
3920	Bearing, Front Output Shaft Front Cup	1
3872	Bearing, Front Output Shaft Rear Cone	1
3820	Bearing, Front Output Shaft Rear Cup	1
SLS-1780	Seal, Input Shaft	1
SLS-1781	Seal, Thrushaft	1
TL-0.5ML	Threadlocker	1
SEALANT	RTV Silicone	1

\*LINE ITEMS WITH "\*" COMBINE INTO INDUSTRY PART NUMBER MU1309CBVV1

NDK421-V100		
Part No.	Description	Qty.
42346	Bearing, Diff Right Hand Cone	1
42584	Bearing, Diff Right Hand Cup	1
68462	Bearing, Diff Left Hand Cone	1
68712	Bearing, Diff Left Hand Cup	1
72212C	Bearing, Pinion Head & Pinion Tail Cone	2
72487	Bearing, Pinion Head & Pinion Tail Cup	2
WUS61308UM	Bearing, Pinion Nose CRB	1
MU1309CBVV1 (Inner Ring)*	Bearing, Output Shaft Rear CRB-IR	1
MU1309CBVV1 (Outer Ring)*	Bearing, Output Shaft Rear CRB-OR	1
JH211749	Bearing, Input Shaft Front Cone	1
JH211710	Bearing, Input Shaft Front Cup	1
JM511946	Bearing, Input Shaft Rear Cone	1
JM511910	Bearing, Input Shaft Rear Cup	1
3979	Bearing, Front Output Shaft Front Cone	1
3920	Bearing, Front Output Shaft Front Cup	1
3872	Bearing, Front Output Shaft Rear Cone	1
3820	Bearing, Front Output Shaft Rear Cup	1
SLS-1780	Seal, Input Shaft	1
SLS-1781	Seal, Thrushaft	1

\*LINE ITEMS WITH "\*" COMBINE INTO INDUSTRY PART NUMBER MU1309CBVV1

NDK422		
Part No.	Description	Qty.
567	Bearing, Diff Right Hand Cone	1
563	Bearing, Diff Right Hand Cup	1
497	Bearing, Diff Left Hand Cone	1
493	Bearing, Diff Left Hand Cup	1
72218C	Bearing, Pinion Head Cone	1
72487	Bearing, Pinion Head Cup	1
HM807049	Bearing, Pinion Tail Cone	1
HM807010	Bearing, Pinion Tail Cup	1
WUB61307UM	Bearing, Pinion Nose CRB	1
MUF1208CBXV1	Bearing, Outer Pinion Support CRB	1
3979	Bearing, Input Shaft Front Cone	1
JM511910	Bearing, Input Shaft Front Cup	1
29675	Bearing, Input Shaft Rear Cone	1
29620	Bearing, Input Shaft Rear Cup	1
3870	Bearing, Front Output Shaft Front Cone	1
3720	Bearing, Front Output Shaft Front Cup	1
LM501349	Bearing, Front Output Shaft Rear Cone	1
LM501310	Bearing, Front Output Shaft Rear Cup	1
MA1209TV (Inner Ring)*	Bearing, Rear Output Shaft CRB-IR	1
MA1209TV (Outer Ring)*	Bearing, Rear Output Shaft CRB-OR	1
SLS-1695	Seal, Input Shaft	1
SLS-1694	Seal, Thrushaft	2
TL-0.5ML	Threadlocker	1
SEALANT	RTV Silicone	1

\*LINE ITEMS WITH "\*" COMBINE INTO INDUSTRY PART NUMBER MA1209TV

NDK422-V100		
Part No.	Description	Qty.
567	Bearing, Diff Right Hand Cone	1
563	Bearing, Diff Right Hand Cup	1
497	Bearing, Diff Left Hand Cone	1
493	Bearing, Diff Left Hand Cup	1
72218C	Bearing, Pinion Head Cone	1
72487	Bearing, Pinion Head Cup	1
HM807049	Bearing, Pinion Tail Cone	1
HM807010	Bearing, Pinion Tail Cup	1
WUB61307UM	Bearing, Pinion Nose CRB	1
MUF1208CBXV1	Bearing, Outer Pinion Support CRB	1
3979	Bearing, Input Shaft Front Cone	1
JM511910	Bearing, Input Shaft Front Cup	1
29675	Bearing, Input Shaft Rear Cone	1
29620	Bearing, Input Shaft Rear Cup	1
3870	Bearing, Front Output Shaft Front Cone	1
3720	Bearing, Front Output Shaft Front Cup	1
LM501349	Bearing, Front Output Shaft Rear Cone	1
LM501310	Bearing, Front Output Shaft Rear Cup	1
MA1209TV (Inner Ring)*	Bearing, Rear Output Shaft CRB-IR	1
MA1209TV (Outer Ring)*	Bearing, Rear Output Shaft CRB-OR	1
SLS-1695	Seal, Input Shaft	1
SLS-1694	Seal, Thrushaft	2

\*LINE ITEMS WITH "\*" COMBINE INTO INDUSTRY PART NUMBER MA1209TV

NDK424		
Part No.	Description	Qty.
56425	Bearing, Diff Right Hand Cone	1
56650	Bearing, Diff Right Hand Cup	1
497	Bearing, Diff Left Hand Cone	1
493	Bearing, Diff Left Hand Cup	1
72218C	Bearing, Pinion Head Cone	1
72487	Bearing, Pinion Head Cup	1
HM807049	Bearing, Pinion Tail Cone	1
HM807010	Bearing, Pinion Tail Cup	1
WUB61307UM	Bearing, Pinion Nose CRB	1
3979	Bearing, Input Shaft Front Cone	1
JM511910	Bearing, Input Shaft Front Cup	1
29675	Bearing, Input Shaft Rear Cone	1
29620	Bearing, Input Shaft Rear Cup	1
3780	Bearing, Front Output Shaft Front Cone	1
3720	Bearing, Front Output Shaft Front Cup	1
LM501349	Bearing, Front Output Shaft Rear Cone	1
LM501310	Bearing, Front Output Shaft Rear Cup	1
MA1209TVV1 (Inner Ring)*	Bearing, Outer Pinion Support CRB-IR	1
MUF1209TVV1 (Outer Ring)*	Bearing, Outer Pinion Support CRB-OR	1
SLS-1694	Seal, Input Shaft	1
SLS-1695	Seal, Front Thrushaft & Rear Thrushaft	2
TL-0.5ML	Threadlocker	1
SEALANT	RTV Silicone	1

\* LINE ITEMS WITH "\*" COMBINE INTO INDUSTRY PART NUMBER MA1209TVV1

NDK424-V100		
Part No.	Description	Qty.
56425	Bearing, Diff Right Hand Cone	1
56650	Bearing, Diff Right Hand Cup	1
497	Bearing, Diff Left Hand Cone	1
493	Bearing, Diff Left Hand Cup	1
72218C	Bearing, Pinion Head Cone	1
72487	Bearing, Pinion Head Cup	1
HM807049	Bearing, Pinion Tail Cone	1
HM807010	Bearing, Pinion Tail Cup	1
WUB61307UM	Bearing, Pinion Nose CRB	1
3979	Bearing, Input Shaft Front Cone	1
JM511910	Bearing, Input Shaft Front Cup	1
29675	Bearing, Input Shaft Rear Cone	1
29620	Bearing, Input Shaft Rear Cup	1
3780	Bearing, Front Output Shaft Front Cone	1
3720	Bearing, Front Output Shaft Front Cup	1
LM501349	Bearing, Front Output Shaft Rear Cone	1
LM501310	Bearing, Front Output Shaft Rear Cup	1
MA1209TVV1 (Inner Ring)*	Bearing, Outer Pinion Support CRB-IR	1
MUF1209TVV1 (Outer Ring)*	Bearing, Outer Pinion Support CRB-OR	1
SLS-1694	Seal, Input Shaft	1
SLS-1695	Seal, Front Thrushaft & Rear Thrushaft	2

\* LINE ITEMS WITH "\*" COMBINE INTO INDUSTRY PART NUMBER MA1209TVV1

NDK426		
Part No.	Description	Qty.
42346	Bearing, Diff Right Hand Cone	1
42584	Bearing, Diff Right Hand Cup	1
68462	Bearing, Diff Left Hand Cone	1
68712	Bearing, Diff Left Hand Cup	1
72212C	Bearing, Pinion Head & Pinion Tail, Cone	2
72487	Bearing, Pinion Head & Pinion Tail, Cup	2
WUS61308UM	Bearing, Pinion Nose CRB	1
MU1309CBXV1 (Inner Ring)*	Bearing, Outer Pinion Support CRB-IR	1
MU1309CBXV1 (Outer Ring)*	Bearing, Outer Pinion Support CRB-OR	1
JM511946	Bearing, Input Shaft Front Cone	1
JM511910	Bearing, Input Shaft Front Cup	1
33275	Bearing, Input Shaft Rear Cone	1
33472	Bearing, Input Shaft Rear Cup	1
3979	Bearing, Front Output Shaft Front Cone	1
3920	Bearing, Front Output Shaft Front Cup	1
HM88649	Bearing, Front Output Shaft Rear Cone	1
HM88610	Bearing, Front Output Shaft Rear Cup	1
MA1211UB	Bearing, Rear Output Shaft CRB	1
SLS-1780	Seal, Input Shaft	1
SLS-1781	Seal, Front Thrushaft & Rear Thrushaft	2
TL-0.5ML	Threadlocker	1
SEALANT	RTV Silicone	1

\* LINE ITEMS WITH "\*" COMBINE INTO INDUSTRY PART NUMBER MU1309CBXV1

NDK426-V100		
Part No.	Description	Qty.
42346	Bearing, Diff Right Hand Cone	1
42584	Bearing, Diff Right Hand Cup	1
68462	Bearing, Diff Left Hand Cone	1
68712	Bearing, Diff Left Hand Cup	1
72212C	Bearing, Pinion Head & Pinion Tail, Cone	2
72487	Bearing, Pinion Head & Pinion Tail, Cup	2
WUS61308UM	Bearing, Pinion Nose CRB	1
MU1309CBXV1 (Inner Ring)*	Bearing, Outer Pinion Support CRB-IR	1
MU1309CBXV1 (Outer Ring)*	Bearing, Outer Pinion Support CRB-OR	1
JM511946	Bearing, Input Shaft Front Cone	1
JM511910	Bearing, Input Shaft Front Cup	1
33275	Bearing, Input Shaft Rear Cone	1
33472	Bearing, Input Shaft Rear Cup	1
3979	Bearing, Front Output Shaft Front Cone	1
3920	Bearing, Front Output Shaft Front Cup	1
HM88649	Bearing, Front Output Shaft Rear Cone	1
HM88610	Bearing, Front Output Shaft Rear Cup	1
MA1211UB	Bearing, Rear Output Shaft CRB	1
SLS-1780	Seal, Input Shaft	1
SLS-1781	Seal, Front Thrushaft & Rear Thrushaft	2

\* LINE ITEMS WITH "\*" COMBINE INTO INDUSTRY PART NUMBER MU1309CBXV1

NDK427		
Part No.	Description	Qty.
NP799449	Bearing, Diff Right Hand Cone	1
NP105857	Bearing, Diff Right Hand Cup	1
XL497	Bearing, Diff Left Hand Cone	1
493	Bearing, Diff Left Hand Cup	1
72218C	Bearing, Pinion Head Cone	1
72487	Bearing, Pinion Head Cup	1
55212C	Bearing, Pinion Tail Cone	1
55437	Bearing, Pinion Tail Cup	1
MUB1307UBM	Bearing, Pinion Nose CRB	1
NP930036	Bearing, Input Shaft Front Cone	1
NP193660	Bearing, Input Shaft Front Cup	1
29675	Bearing, Input Shaft Rear Cone	1
29630	Bearing, Input Shaft Rear Cup	1
LM104949	Bearing, Output Shaft Front & Rear Cone	2
JLM104910	Bearing, Output Shaft Front & Rear Cup	2
SLS-1699	Seal, Input Shaft	1
SLS-1701	Seal, Thrushaft	1
TL-0.5ML	Threadlocker	1
SEALANT	RTV Silicone	1

NDK427- V100		
Part No.	Description	Qty.
NP799449	Bearing, Diff Right Hand Cone	1
NP105857	Bearing, Diff Right Hand Cup	1
XL497	Bearing, Diff Left Hand Cone	1
493	Bearing, Diff Left Hand Cup	1
72218C	Bearing, Pinion Head Cone	1
72487	Bearing, Pinion Head Cup	1
55212C	Bearing, Pinion Tail Cone	1
55437	Bearing, Pinion Tail Cup	1
MUB1307UBM	Bearing, Pinion Nose CRB	1
NP930036	Bearing, Input Shaft Front Cone	1
NP193660	Bearing, Input Shaft Front Cup	1
29675	Bearing, Input Shaft Rear Cone	1
29630	Bearing, Input Shaft Rear Cup	1
LM104949	Bearing, Output Shaft Front & Rear Cone	2
JLM104910	Bearing, Output Shaft Front & Rear Cup	2
SLS-1699	Seal, Input Shaft	1
SLS-1701	Seal, Thrushaft	1

NDK427A		
Part No.	Description	Qty.
NP799449	Bearing, Diff Right Hand Cone	1
NP105857	Bearing, Diff Right Hand Cup	1
XL497	Bearing, Diff Left Hand Cone	1
493	Bearing, Diff Left Hand Cup	1
72218C	Bearing, Pinion Head Cone	1
72487	Bearing, Pinion Head Cup	1
55212C	Bearing, Pinion Tail Cone	1
55437	Bearing, Pinion Tail Cup	1
MUB1307UBM	Bearing, Pinion Nose CRB	1
NP930036	Bearing, Input Shaft Front Cone	1
NP193660	Bearing, Input Shaft Front Cup	1
29688	Bearing, Input Shaft Rear Cone	1
29620	Bearing, Input Shaft Rear Cup	1
LM104949	Bearing, Output Shaft Front & Rear Cone	2
JLM104910	Bearing, Output Shaft Front & Rear Cup	2
SLS-1699	Seal, Input Shaft	1
SLS-1701	Seal, Thrushaft	1
TL-0.5ML	Threadlocker	1
SEALANT	RTV Silicone	1

NDK427A- V100		
Part No.	Description	Qty.
NP799449	Bearing, Diff Right Hand Cone	1
NP105857	Bearing, Diff Right Hand Cup	1
XL497	Bearing, Diff Left Hand Cone	1
493	Bearing, Diff Left Hand Cup	1
72218C	Bearing, Pinion Head Cone	1
72487	Bearing, Pinion Head Cup	1
55212C	Bearing, Pinion Tail Cone	1
55437	Bearing, Pinion Tail Cup	1
MUB1307UBM	Bearing, Pinion Nose CRB	1
NP930036	Bearing, Input Shaft Front Cone	1
NP193660	Bearing, Input Shaft Front Cup	1
29688	Bearing, Input Shaft Rear Cone	1
29620	Bearing, Input Shaft Rear Cup	1
LM104949	Bearing, Output Shaft Front & Rear Cone	2
JLM104910	Bearing, Output Shaft Front & Rear Cup	2
SLS-1699	Seal, Input Shaft	1
SLS-1701	Seal, Thrushaft	1

NDK428		
Part No.	Description	Qty.
NP799449	Bearing, Diff Right Hand Cone	1
NP105857	Bearing, Diff Right Hand Cup	1
42362	Bearing, Diff Left Hand Cone	1
42584	Bearing, Diff Left Hand Cup	1
72218C	Bearing, Pinion Head Cone	1
72487	Bearing, Pinion Head Cup	1
55212C	Bearing, Pinion Tail Cone	1
55437	Bearing, Pinion Tail Cup	1
MUB1307UBM	Bearing, Pinion Nose CRB	1
NP930036	Bearing, Input Shaft Front Cone	1
NP193660	Bearing, Input Shaft Front Cup	1
29675	Bearing, Input Shaft Rear Cone	1
29630	Bearing, Input Shaft Rear Cup	1
LM104949	Bearing, Output Shaft Front & Rear Cone	2
JLM104910	Bearing, Output Shaft Front & Rear Cup	2
SLS-1699	Seal, Input Shaft	1
SLS-1701	Seal, Thrushaft	1
TL-0.5ML	Threadlocker	1
SEALANT	RTV Silicone	1

NDK428-V100		
Part No.	Description	Qty.
NP799449	Bearing, Diff Right Hand Cone	1
NP105857	Bearing, Diff Right Hand Cup	1
42362	Bearing, Diff Left Hand Cone	1
42584	Bearing, Diff Left Hand Cup	1
72218C	Bearing, Pinion Head Cone	1
72487	Bearing, Pinion Head Cup	1
55212C	Bearing, Pinion Tail Cone	1
55437	Bearing, Pinion Tail Cup	1
MUB1307UBM	Bearing, Pinion Nose CRB	1
NP930036	Bearing, Input Shaft Front Cone	1
NP193660	Bearing, Input Shaft Front Cup	1
29675	Bearing, Input Shaft Rear Cone	1
29630	Bearing, Input Shaft Rear Cup	1
LM104949	Bearing, Output Shaft Front & Rear Cone	2
JLM104910	Bearing, Output Shaft Front & Rear Cup	2
SLS-1699	Seal, Input Shaft	1
SLS-1701	Seal, Thrushaft	1

NDK428A		
Part No.	Description	Qty.
NP799449	Bearing, Diff Right Hand Cone	1
NP105857	Bearing, Diff Right Hand Cup	1
42362	Bearing, Diff Left Hand Cone	1
42584	Bearing, Diff Left Hand Cup	1
72218C	Bearing, Pinion Head Cone	1
72487	Bearing, Pinion Head Cup	1
55212C	Bearing, Pinion Tail Cone	1
55437	Bearing, Pinion Tail Cup	1
MUB1307UBM	Bearing, Pinion Nose CRB	1
NP930036	Bearing, Input Shaft Front Cone	1
NP193660	Bearing, Input Shaft Front Cup	1
29688	Bearing, Input Shaft Rear Cone	1
29620	Bearing, Input Shaft Rear Cup	1
LM104949	Bearing, Output Shaft Front & Rear Cone	2
JLM104910	Bearing, Output Shaft Front & Rear Cup	2
SLS-1699	Seal, Input Shaft	1
SLS-1701	Seal, Thrushaft	1
TL-0.5ML	Threadlocker	1
SEALANT	RTV Silicone	1

NDK428A-V100		
Part No.	Description	Qty.
NP799449	Bearing, Diff Right Hand Cone	1
NP105857	Bearing, Diff Right Hand Cup	1
42362	Bearing, Diff Left Hand Cone	1
42584	Bearing, Diff Left Hand Cup	1
72218C	Bearing, Pinion Head Cone	1
72487	Bearing, Pinion Head Cup	1
55212C	Bearing, Pinion Tail Cone	1
55437	Bearing, Pinion Tail Cup	1
MUB1307UBM	Bearing, Pinion Nose CRB	1
NP930036	Bearing, Input Shaft Front Cone	1
NP193660	Bearing, Input Shaft Front Cup	1
29688	Bearing, Input Shaft Rear Cone	1
29620	Bearing, Input Shaft Rear Cup	1
LM104949	Bearing, Output Shaft Front & Rear Cone	2
JLM104910	Bearing, Output Shaft Front & Rear Cup	2
SLS-1699	Seal, Input Shaft	1
SLS-1701	Seal, Thrushaft	1

NDK429		
Part No.	Description	Qty.
NP799449	Bearing, Diff Right Hand Cone	1
NP105857	Bearing, Diff Right Hand Cup	1
497	Bearing, Diff Left Hand Cone	1
493	Bearing, Diff Left Hand Cup	1
72212C	Bearing, Pinion Head Cone	1
72487	Bearing, Pinion Head Cup	1
55200C	Bearing, Pinion Tail Cone	1
55437	Bearing, Pinion Tail Cup	1
MUB7307UBM	Bearing, Pinion Nose CRB	1
SLS-1699	Seal, Pinion	1
TL-0.5ML	Threadlocker	1
SEALANT	RTV Silicone	1

NDK429-V100		
Part No.	Description	Qty.
NP799449	Bearing, Diff Right Hand Cone	1
NP105857	Bearing, Diff Right Hand Cup	1
497	Bearing, Diff Left Hand Cone	1
493	Bearing, Diff Left Hand Cup	1
72212C	Bearing, Pinion Head Cone	1
72487	Bearing, Pinion Head Cup	1
55200C	Bearing, Pinion Tail Cone	1
55437	Bearing, Pinion Tail Cup	1
MUB7307UBM	Bearing, Pinion Nose CRB	1
SLS-1699	Seal, Pinion	1

NDK430		
Part No.	Description	Qty.
NP799449	Bearing, Diff Right Hand Cone	1
NP105857	Bearing, Diff Right Hand Cup	1
42362	Bearing, Diff Left Hand Cone	1
42584	Bearing, Diff Left Hand Cup	1
72212C	Bearing, Pinion Head Cone	1
72487	Bearing, Pinion Head Cup	1
55200C	Bearing, Pinion Tail Cone	1
55437	Bearing, Pinion Tail Cup	1
MUB7307UBM	Bearing, Pinion Nose CRB	1
SLS-1699	Seal, Pinion	1
TL-0.5ML	Threadlocker	1
SEALANT	RTV Silicone	1

NDK430-V100		
Part No.	Description	Qty.
NP799449	Bearing, Diff Right Hand Cone	1
NP105857	Bearing, Diff Right Hand Cup	1
42362	Bearing, Diff Left Hand Cone	1
42584	Bearing, Diff Left Hand Cup	1
72212C	Bearing, Pinion Head Cone	1
72487	Bearing, Pinion Head Cup	1
55200C	Bearing, Pinion Tail Cone	1
55437	Bearing, Pinion Tail Cup	1
MUB7307UBM	Bearing, Pinion Nose CRB	1
SLS-1699	Seal, Pinion	1

NDK431		
Part No.	Description	Qty.
665	Bearing, Diff Right Cone	1
653	Bearing, Diff Right Cup	1
42381	Bearing, Diff Left Cone	1
42584	Bearing, Diff Left Cup	1
72212C	Bearing, Pinion Head & Tail Cone	2
72487	Bearing, Pinion Head & Tail Cup	2
WUS61308UM	Bearing, Pinion Nose CRB	1
MU1309CB*	Bearing, Outer Pinion Support CRB	1
MU1309UM**	Bearing, Outer Pinion Support CRB	1
JM511946	Bearing, Input Shaft Front Cone	1
JM511910	Bearing, Input Shaft Front Cup	1
33275	Bearing, Output Shaft Front Cone	1
33472	Bearing, Output Shaft Front Cup	1
MA1211UB	Bearing, Output Shaft Rear CRB	1
SLS-1772	Seal, Input	1
SLS-1773	Seal, Thrushaft	1
TL-0.5ML	Threadlocker	1
SEALANT	RTV Silicone	1

NDK431-V100		
Part No.	Description	Qty.
665	Bearing, Diff Right Cone	1
653	Bearing, Diff Right Cup	1
42381	Bearing, Diff Left Cone	1
42584	Bearing, Diff Left Cup	1
72212C	Bearing, Pinion Head & Tail Cone	2
72487	Bearing, Pinion Head & Tail Cup	2
WUS61308UM	Bearing, Pinion Nose CRB	1
MU1309CB*	Bearing, Outer Pinion Support CRB	1
MU1309UM**	Bearing, Outer Pinion Support CRB	1
JM511946	Bearing, Input Shaft Front Cone	1
JM511910	Bearing, Input Shaft Front Cup	1
33275	Bearing, Output Shaft Front Cone	1
33472	Bearing, Output Shaft Front Cup	1
MA1211UB	Bearing, Output Shaft Rear CRB	1
SLS-1772	Seal, Input	1
SLS-1773	Seal, Thrushaft	1

\*BEFORE 2/2000 \*\*AFTER 2/2000

\*BEFORE 2/2000 \*\*AFTER 2/2000



NDK432		
Part No.	Description	Qty.
68462	Bearing, Diff Right Hand Cone	1
68712	Bearing, Diff Right Hand Cup	1
42381	Bearing, Diff Left Hand Cone	1
42584	Bearing, Diff Left Hand Cup	1
72212C	Bearing, Pinion Head & Pinion Tail Cone	1
72487	Bearing, Pinion Head & Pinion Tail Cup	1
WUS61308UM	Bearing, Pinion Nose CRB	1
JM511946	Bearing, Input Shaft Cone	1
JM811910	Bearing, Input Shaft Cup	1
MU1309UMV1	Bearing, Outer Pinion Support CRB	1
33275	Bearing, Output Shaft Front Cone	1
33472	Bearing, Output Shaft Front Cup	1
MA1211V1 (Inner Ring)*	Bearing, Output Shaft Rear CRB	1
MA1211UBV (Outer Ring)*	Bearing, Output Shaft Rear CRB	1
210736	Seal, Input Shaft	1
210737	Seal, Thrushaft	1
TL-0.5ML	Threadlocker	1
SEALANT	RTV Silicone	1

\*LINE ITEMS WITH "\*" COMBINE INTO INDUSTRY PART NUMBER MA1211UBV

NDK432-V100		
Part No.	Description	Qty.
68462	Bearing, Diff Right Hand Cone	1
68712	Bearing, Diff Right Hand Cup	1
42381	Bearing, Diff Left Hand Cone	1
42584	Bearing, Diff Left Hand Cup	1
72212C	Bearing, Pinion Head & Pinion Tail Cone	1
72487	Bearing, Pinion Head & Pinion Tail Cup	1
WUS61308UM	Bearing, Pinion Nose CRB	1
JM511946	Bearing, Input Shaft Cone	1
JM811910	Bearing, Input Shaft Cup	1
MU1309UMV1	Bearing, Outer Pinion Support CRB	1
33275	Bearing, Output Shaft Front Cone	1
33472	Bearing, Output Shaft Front Cup	1
MA1211V1 (Inner Ring)*	Bearing, Output Shaft Rear CRB	1
MA1211UBV (Outer Ring)*	Bearing, Output Shaft Rear CRB	1
210736	Seal, Input Shaft	1
210737	Seal, Thrushaft	1

\*LINE ITEMS WITH "\*" COMBINE INTO INDUSTRY PART NUMBER MA1211UBV

NDK433		
Part No.	Description	Qty.
665	Bearing, Diff Right Hand Cone	1
653	Bearing, Diff Right Hand Cup	1
42381	Bearing, Diff Left Hand Cone	1
42584	Bearing, Diff Left Hand Cup	1
72212C	Bearing, Pinion Head & Tail Cone	2
72487	Bearing, Pinion Head & Tail Cup	2
WUS61308UM	Bearing, Pinion Nose CRB	1
JM511946	Bearing, Input Shaft Cone	1
JM511910	Bearing, Input Shaft Cup	1
33275	Bearing, Output Shaft Front Cone	1
33472	Bearing, Output Shaft Front Cup	1
MA1211UB	Bearing, Output Shaft Rear Cone	1
MU1309UM	Bearing, Pinion Support Cup	1
210736	Seal, Input Shaft	1
210737	Seal, Thrushaft	1
TL-0.5ML	Threadlocker	1
SEALANT	RTV Silicone	1

NDK433-V100		
Part No.	Description	Qty.
665	Bearing, Diff Right Hand Cone	1
653	Bearing, Diff Right Hand Cup	1
42381	Bearing, Diff Left Hand Cone	1
42584	Bearing, Diff Left Hand Cup	1
72212C	Bearing, Pinion Head & Tail Cone	2
72487	Bearing, Pinion Head & Tail Cup	2
WUS61308UM	Bearing, Pinion Nose CRB	1
JM511946	Bearing, Input Shaft Cone	1
JM511910	Bearing, Input Shaft Cup	1
33275	Bearing, Output Shaft Front Cone	1
33472	Bearing, Output Shaft Front Cup	1
MA1211UB	Bearing, Output Shaft Rear Cone	1
MU1309UM	Bearing, Pinion Support Cup	1
210736	Seal, Input Shaft	1
210737	Seal, Thrushaft	1

NDK434		
Part No.	Description	Qty.
3984	Bearing, Diff Right & Left Hand Cone	2
3920	Bearing, Diff Right & Left Hand Cup	2
72212C	Bearing, Pinion Head Cone	1
72487	Bearing, Pinion Head Cup	1
55200C	Bearing, Pinion Tail Cone	1
55437	Bearing, Pinion Tail Cup	1
SLS-1699	Seal, Pinion Shaft	1
TL-0.5ML	Threadlocker	1
SEALANT	RTV Silicone	1

NDK434-V100		
Part No.	Description	Qty.
3984	Bearing, Diff Right & Left Hand Cone	2
3920	Bearing, Diff Right & Left Hand Cup	2
72212C	Bearing, Pinion Head Cone	1
72487	Bearing, Pinion Head Cup	1
55200C	Bearing, Pinion Tail Cone	1
55437	Bearing, Pinion Tail Cup	1
SLS-1699	Seal, Pinion Shaft	1

NDK436		
Part No.	Description	Qty.
NP237087	Bearing, Diff Right Hand Cone	1
NP049312	Bearing, Diff Right Hand Cup	1
NP374995	Bearing, Diff Left Hand Cone	1
NP120322	Bearing, Diff Left Hand Cup	1
NP478770	Bearing, Pinion Head Cone	1
NP547156	Bearing, Pinion Head Cup	1
NP846736	Bearing, Pinion Tail Cone	1
NP166419	Bearing, Pinion Tail Cup	1
HM813844	Bearing, Input Shaft Front Cone	1
HM813810	Bearing, Input Shaft Front Cup	1
NP171276	Bearing, Input Shaft Rear Cone	1
NP943289	Bearing, Input Shaft Rear Cup	1
SLS-1806	Seal, Pinion	1
SLS-1773	Seal, Thrushaft	1
SLS-1702	Seal, Input Shaft V-Ring	1
TL-0.5ML	Threadlocker	1
SEALANT	RTV Silicone	1

NDK436-V100		
Part No.	Description	Qty.
NP237087	Bearing, Diff Right Hand Cone	1
NP049312	Bearing, Diff Right Hand Cup	1
NP374995	Bearing, Diff Left Hand Cone	1
NP120322	Bearing, Diff Left Hand Cup	1
NP478770	Bearing, Pinion Head Cone	1
NP547156	Bearing, Pinion Head Cup	1
NP846736	Bearing, Pinion Tail Cone	1
NP166419	Bearing, Pinion Tail Cup	1
HM813844	Bearing, Input Shaft Front Cone	1
HM813810	Bearing, Input Shaft Front Cup	1
NP171276	Bearing, Input Shaft Rear Cone	1
NP943289	Bearing, Input Shaft Rear Cup	1
SLS-1806	Seal, Pinion	1
SLS-1773	Seal, Thrushaft	1
SLS-1702	Seal, Input Shaft V-Ring	1

NDK437		
Part No.	Description	Qty.
NP237087	Bearing, Diff Right Hand Cone	1
NP049312	Bearing, Diff Right Hand Cup	1
NP374995	Bearing, Diff Left Hand Cone	1
NP120322	Bearing, Diff Left Hand Cup	1
NP478770	Bearing, Pinion Head Cone	1
NP547156	Bearing, Pinion Head Cup	1
NP846736	Bearing, Pinion Tail Cone	1
NP166419	Bearing, Pinion Tail Cup	1
WUB61308UM	Bearing, Pinion Nose CRB	1
HM813844	Bearing, Input Shaft Front Cone	1
HM813810	Bearing, Input Shaft Front Cup	1
NP171276	Bearing, Input Shaft Rear Cone	1
NP943289	Bearing, Input Shaft Rear Cup	1
SLS-1806	Seal, Pinion	1
SLS-1702	Seal, Input Shaft V-Ring	1
SLS-1773	Seal, Thrushaft	1
TL-0.5ML	Threadlocker	1
SEALANT	RTV Silicone	1

NDK437-V100		
Part No.	Description	Qty.
NP237087	Bearing, Diff Right Hand Cone	1
NP049312	Bearing, Diff Right Hand Cup	1
NP374995	Bearing, Diff Left Hand Cone	1
NP120322	Bearing, Diff Left Hand Cup	1
NP478770	Bearing, Pinion Head Cone	1
NP547156	Bearing, Pinion Head Cup	1
NP846736	Bearing, Pinion Tail Cone	1
NP166419	Bearing, Pinion Tail Cup	1
WUB61308UM	Bearing, Pinion Nose CRB	1
HM813844	Bearing, Input Shaft Front Cone	1
HM813810	Bearing, Input Shaft Front Cup	1
NP171276	Bearing, Input Shaft Rear Cone	1
NP943289	Bearing, Input Shaft Rear Cup	1
SLS-1806	Seal, Pinion	1
SLS-1702	Seal, Input Shaft V-Ring	1
SLS-1773	Seal, Thrushaft	1

NDK438		
Part No.	Description	Qty.
NP374995	Bearing, Diff Right & Left Hand Cone	2
NP120322	Bearing, Diff Right & Left Hand Cup	2
NP478770	Bearing, Pinion Head Cone	1
NP927527	Bearing, Pinion Tail Cone	1
NP547156	Bearing, Pinion Head & Tail Cup	2
WUB61308UM	Bearing, Pinion Nose CRB	1
SLS-1806	Seal, Pinion	1
TL-0.5ML	Threadlocker	1
SEALANT	RTV Silicone	1

NDK438-V100		
Part No.	Description	Qty.
NP374995	Bearing, Diff Right & Left Hand Cone	2
NP120322	Bearing, Diff Right & Left Hand Cup	2
NP478770	Bearing, Pinion Head Cone	1
NP927527	Bearing, Pinion Tail Cone	1
NP547156	Bearing, Pinion Head & Tail Cup	2
WUB61308UM	Bearing, Pinion Nose CRB	1
SLS-1806	Seal, Pinion	1

NDK439		
Part No.	Description	Qty.
NP374995	Bearing, Diff Right & Left Hand Cone	2
NP120322	Bearing, Diff Right & Left Hand Cup	2
NP478770	Bearing, Pinion Head Cone	1
NP927527	Bearing, Pinion Tail Cone	2
NP547156	Bearing, Pinion Head & Tail Cup	1
SLS-1806	Seal, Pinion	1
TL-0.5ML	Threadlocker	1
SEALANT	RTV Silicone	1

NDK439-V100		
Part No.	Description	Qty.
NP374995	Bearing, Diff Right & Left Hand Cone	2
NP120322	Bearing, Diff Right & Left Hand Cup	2
NP478770	Bearing, Pinion Head Cone	1
NP927527	Bearing, Pinion Tail Cone	2
NP547156	Bearing, Pinion Head & Tail Cup	1
SLS-1806	Seal, Pinion	1

NDK440		
Part No.	Description	Qty.
NP237087	Bearing, Diff Right Hand Cone	1
NP049312	Bearing, Diff Right Hand Cup	1
NP374995	Bearing, Diff Left Hand Cone	1
NP120322	Bearing, Diff Left Hand Cup	1
NP478770	Bearing, Pinion Head Cone	1
NP927527	Bearing, Pinion Tail Cone	1
NP547156	Bearing, Pinion Head & Tail Cup	2
WUB61308UM	Bearing, Pinion Nose CRB	1
SLS-1806	Seal, Pinion	1
TL-0.5ML	Threadlocker	1
SEALANT	RTV Silicone	1

NDK440-V100		
Part No.	Description	Qty.
NP237087	Bearing, Diff Right Hand Cone	1
NP049312	Bearing, Diff Right Hand Cup	1
NP374995	Bearing, Diff Left Hand Cone	1
NP120322	Bearing, Diff Left Hand Cup	1
NP478770	Bearing, Pinion Head Cone	1
NP927527	Bearing, Pinion Tail Cone	1
NP547156	Bearing, Pinion Head & Tail Cup	2
WUB61308UM	Bearing, Pinion Nose CRB	1
SLS-1806	Seal, Pinion	1

NDK441		
Part No.	Description	Qty.
NP237087	Bearing, Diff Right Hand Cone	1
NP049312	Bearing, Diff Right Hand Cup	1
NP374995	Bearing, Diff Left Hand Cone	1
NP120322	Bearing, Diff Left Hand Cup	1
NP478770	Bearing, Pinion Head Cone	1
NP927527	Bearing, Pinion Tail Cone	1
NP547156	Bearing, Pinion Head & Tail Cup	2
WUB61308UM	Bearing, Pinion Nose CRB	1
SLS-1806	Seal, Pinion	1
TL-0.5ML	Threadlocker	1
SEALANT	RTV Silicone	1

NDK441-V100		
Part No.	Description	Qty.
NP237087	Bearing, Diff Right Hand Cone	1
NP049312	Bearing, Diff Right Hand Cup	1
NP374995	Bearing, Diff Left Hand Cone	1
NP120322	Bearing, Diff Left Hand Cup	1
NP478770	Bearing, Pinion Head Cone	1
NP927527	Bearing, Pinion Tail Cone	1
NP547156	Bearing, Pinion Head & Tail Cup	2
WUB61308UM	Bearing, Pinion Nose CRB	1
SLS-1806	Seal, Pinion	1

NDK442		
Part No.	Description	Qty.
NP374995	Bearing, Diff Right & Left Hand Cone	2
NP120322	Bearing, Diff Right & Left Hand Cup	2
NP478770	Bearing, Pinion Head Cone	1
NP547156	Bearing, Pinion Head Cup	1
NP846736	Bearing, Pinion Tail Cone	1
NP166419	Bearing, Pinion Tail Cup	1
HM813844	Bearing, Input Shaft Front Cone	1
HM813810	Bearing, Input Shaft Front Cup	1
NP171276	Bearing, Input Shaft Rear Cone	1
NP943289	Bearing, Input Shaft Rear Cup	1
SLS-1702	Seal, Input Shaft	1
SLS-1773	Seal, Thrushaft	1
SLS-1806	Seal, Input Shaft V-Ring	1
TL-0.5ML	Threadlocker	1
SEALANT	RTV Silicone	1

NDK442-V100		
Part No.	Description	Qty.
NP374995	Bearing, Diff Right & Left Hand Cone	2
NP120322	Bearing, Diff Right & Left Hand Cup	2
NP478770	Bearing, Pinion Head Cone	1
NP547156	Bearing, Pinion Head Cup	1
NP846736	Bearing, Pinion Tail Cone	1
NP166419	Bearing, Pinion Tail Cup	1
HM813844	Bearing, Input Shaft Front Cone	1
HM813810	Bearing, Input Shaft Front Cup	1
NP171276	Bearing, Input Shaft Rear Cone	1
NP943289	Bearing, Input Shaft Rear Cup	1
SLS-1702	Seal, Input Shaft	1
SLS-1773	Seal, Thrushaft	1
SLS-1806	Seal, Input Shaft V-Ring	1

NDK443		
Part No.	Description	Qty.
NP237087	Bearing, Diff Right Hand Cone	1
NP049312	Bearing, Diff Right Hand Cup	1
NP374995	Bearing, Diff Left Hand Cone	1
NP120322	Bearing, Diff Left Hand Cup	1
NP478770	Bearing, Pinion Head Cone	1
NP927527	Bearing, Pinion Tail Cone	1
NP547156	Bearing, Pinion Head & Tail Cup	2
WUB61308UM	Bearing, Pinion Nose CRB	1
SLS-1806	Seal, Pinion	1
TL-0.5ML	Threadlocker	1
SEALANT	RTV Silicone	1

NDK443-V100		
Part No.	Description	Qty.
NP237087	Bearing, Diff Right Hand Cone	1
NP049312	Bearing, Diff Right Hand Cup	1
NP374995	Bearing, Diff Left Hand Cone	1
NP120322	Bearing, Diff Left Hand Cup	1
NP478770	Bearing, Pinion Head Cone	1
NP927527	Bearing, Pinion Tail Cone	1
NP547156	Bearing, Pinion Head & Tail Cup	2
WUB61308UM	Bearing, Pinion Nose CRB	1
SLS-1806	Seal, Pinion	1

NDK444		
Part No.	Description	Qty.
NP237087	Bearing, Diff Right Hand Cone	1
NP049312	Bearing, Diff Right Hand Cup	1
NP374995	Bearing, Diff Left Hand Cone	1
NP120322	Bearing, Diff Left Hand Cup	1
NP478770	Bearing, Pinion Head Cone	1
NP927527	Bearing, Pinion Tail Cone	1
NP547156	Bearing, Pinion Head & Tail Cup	2
SLS-1806	Seal, Pinion	1
TL-0.5ML	Threadlocker	1
SEALANT	RTV Silicone	1

NDK444-V100		
Part No.	Description	Qty.
NP237087	Bearing, Diff Right Hand Cone	1
NP049312	Bearing, Diff Right Hand Cup	1
NP374995	Bearing, Diff Left Hand Cone	1
NP120322	Bearing, Diff Left Hand Cup	1
NP478770	Bearing, Pinion Head Cone	1
NP927527	Bearing, Pinion Tail Cone	1
NP547156	Bearing, Pinion Head & Tail Cup	2
SLS-1806	Seal, Pinion	1

NDK445		
Part No.	Description	Qty.
567	Bearing, Diff Right Hand Cone	1
563	Bearing, Diff Right Hand Cup	1
497	Bearing, Diff Left Hand Cone	1
493	Bearing, Diff Left Hand Cup	1
72200C	Bearing, Pinion Head Cone	1
72487	Bearing, Pinion Head Cup	1
55200C	Bearing, Pinion Tail Cone	1
55437	Bearing, Pinion Tail Cup	1
MUB7307UBM	Bearing, Pinion Nose CRB	1
SLS-1699	Seal, Pinion	1
TL-0.5ML	Threadlocker	1
SEALANT	RTV Silicone	1

NDK445-V100		
Part No.	Description	Qty.
567	Bearing, Diff Right Hand Cone	1
563	Bearing, Diff Right Hand Cup	1
497	Bearing, Diff Left Hand Cone	1
493	Bearing, Diff Left Hand Cup	1
72200C	Bearing, Pinion Head Cone	1
72487	Bearing, Pinion Head Cup	1
55200C	Bearing, Pinion Tail Cone	1
55437	Bearing, Pinion Tail Cup	1
MUB7307UBM	Bearing, Pinion Nose CRB	1
SLS-1699	Seal, Pinion	1

NDK449		
Part No.	Description	Qty.
42381	Bearing, Diff Right Hand Cone	1
42584	Bearing, Diff Right Hand Cup	1
665	Bearing, Diff Left Hand Cone	1
653	Bearing, Diff Left Hand Cup	1
78215C	Bearing, Pinion Head Cone	1
78551	Bearing, Pinion Head Cup	1
72212C	Bearing, Pinion Tail Cone	1
72487	Bearing, Pinion Tail Cup	1
WUS61308UM	Bearing, Pinion Nose CRB	1
210724	Seal, Pinion	1
TL-0.5ML	Threadlocker	1
SEALANT	RTV Silicone	1

NDK449-V100		
Part No.	Description	Qty.
42381	Bearing, Diff Right Hand Cone	1
42584	Bearing, Diff Right Hand Cup	1
665	Bearing, Diff Left Hand Cone	1
653	Bearing, Diff Left Hand Cup	1
78215C	Bearing, Pinion Head Cone	1
78551	Bearing, Pinion Head Cup	1
72212C	Bearing, Pinion Tail Cone	1
72487	Bearing, Pinion Tail Cup	1
WUS61308UM	Bearing, Pinion Nose CRB	1
210724	Seal, Pinion	1

NDK500		
Part No.	Description	Qty.
47687	Bearing, Diff Right Hand Cone	1
47623A	Bearing, Diff Right Hand Cup	1
HM516448	Bearing, Diff Left Hand Cone	1
HM516414B	Bearing, Diff Left Hand Cup	1
596	Bearing, Pinion Head Cone	1
592A	Bearing, Pinion Head Cup	1
H715348	Bearing, Pinion Tail Cone	1
H715334	Bearing, Cross Shaft Right Cone	1
H715345	Bearing, Cross Shaft Left Cone	1
H715311	Bearing, Pinion Tail, Cross Shaft Right & Left Cup	3
BL213N	Bearing, Input Shaft DGBB	1
BL211	Bearing, Inter Axle DGBB	1
CR34882	Seal, Input Shaft	1
CR27558	Seal, Thrushaft	1
OR256	O-Ring	1
OR260	O-Ring	1
OR270	O-Ring	1
Gasket Kit	Gasket Kit	1
TL-0.5ML	Threadlocker	1
SEALANT	RTV Silicone	1

NDK500-V100		
Part No.	Description	Qty.
47687	Bearing, Diff Right Hand Cone	1
47623A	Bearing, Diff Right Hand Cup	1
HM516448	Bearing, Diff Left Hand Cone	1
HM516414B	Bearing, Diff Left Hand Cup	1
596	Bearing, Pinion Head Cone	1
592A	Bearing, Pinion Head Cup	1
H715348	Bearing, Pinion Tail Cone	1
H715334	Bearing, Cross Shaft Right Cone	1
H715345	Bearing, Cross Shaft Left Cone	1
H715311	Bearing, Pinion Tail, Cross Shaft Right & Left Cup	3
BL213N	Bearing, Input Shaft DGBB	1
BL211	Bearing, Inter Axle DGBB	1
CR34882	Seal, Input Shaft	1
CR27558	Seal, Thrushaft	1
OR256	O-Ring	1
OR260	O-Ring	1
OR270	O-Ring	1
Gasket Kit	Gasket Kit	1

NDK501		
Part No.	Description	Qty.
47687	Bearing, Diff Right Hand Cone	1
47623A	Bearing, Diff Right Hand Cup	1
HM516448	Bearing, Diff Left Hand Cone	1
HM516414B	Bearing, Diff Left Hand Cup	1
6466	Bearing, Pinion Head Cone	1
6420	Bearing, Pinion Head Cup	1
H715334	Bearing, Pinion Tail & Cross Shaft Right Cone	2
H715345	Bearing, Cross Shaft Left Cone	1
H715311	Bearing, Pinion Tail, Cross Shaft Right & Left Cup	3
CR34882	Seal, Input Shaft	1
OR256	O-Ring	1
OR270	O-Ring	1
Gasket Kit	Gasket Kit	1
TL-0.5ML	Threadlocker	1
SEALANT	RTV Silicone	1

NDK501-V100		
Part No.	Description	Qty.
47687	Bearing, Diff Right Hand Cone	1
47623A	Bearing, Diff Right Hand Cup	1
HM516448	Bearing, Diff Left Hand Cone	1
HM516414B	Bearing, Diff Left Hand Cup	1
6466	Bearing, Pinion Head Cone	1
6420	Bearing, Pinion Head Cup	1
H715334	Bearing, Pinion Tail & Cross Shaft Right Cone	2
H715345	Bearing, Cross Shaft Left Cone	1
H715311	Bearing, Pinion Tail, Cross Shaft Right & Left Cup	3
CR34882	Seal, Input Shaft	1
OR256	O-Ring	1
OR270	O-Ring	1
Gasket Kit	Gasket Kit	1

NDK503		
Part No.	Description	Qty.
47687	Bearing, Diff Right Hand Cone	1
47623A	Bearing, Diff Right Hand Cup	1
HM516448	Bearing, Diff Left Hand Cone	1
HM516414B	Bearing, Diff Left Hand Cup	1
5760	Bearing, Pinion Head Cone	1
5735	Bearing, Pinion Head Cup	1
559	Bearing, Pinion Tail Cone	1
552A	Bearing, Pinion Tail Cup	1
621	Bearing, Cross Shaft Right Cone	1
612	Bearing, Cross Shaft Right Cup	1
H715345	Bearing, Cross Shaft Left Cone	1
H715313W	Bearing, Cross Shaft Left Cup	1
CR34882	Seal, Pinion	1
56AX450	O-Ring	1
OR160	O-Ring	1
OR260	O-Ring	1
OR270	O-Ring	1
Gasket Kit	Gasket Kit	1
TL-0.5ML	Threadlocker	1
SEALANT	RTV Silicone	1

NDK503-V100		
Part No.	Description	Qty.
47687	Bearing, Diff Right Hand Cone	1
47623A	Bearing, Diff Right Hand Cup	1
HM516448	Bearing, Diff Left Hand Cone	1
HM516414B	Bearing, Diff Left Hand Cup	1
5760	Bearing, Pinion Head Cone	1
5735	Bearing, Pinion Head Cup	1
559	Bearing, Pinion Tail Cone	1
552A	Bearing, Pinion Tail Cup	1
621	Bearing, Cross Shaft Right Cone	1
612	Bearing, Cross Shaft Right Cup	1
H715345	Bearing, Cross Shaft Left Cone	1
H715313W	Bearing, Cross Shaft Left Cup	1
CR34882	Seal, Pinion	1
56AX450	O-Ring	1
OR160	O-Ring	1
OR260	O-Ring	1
OR270	O-Ring	1
Gasket Kit	Gasket Kit	1

NDK506		
Part No.	Description	Qty.
77375	Bearing, Diff Right & Left Hand Cone	2
77676W	Bearing, Diff Right Hand Cup	1
77676BW	Bearing, Diff Left Hand Cup	1
6460	Bearing, Pinion Head Cone	1
6420	Bearing, Pinion Head Cup	1
65225	Bearing, Pinion Tail Cone	1
65500	Bearing, Pinion Tail Cup	1
835	Bearing, Cross Shaft Right Cone	1
833W	Bearing, Cross Shaft Right Cup	1
6576	Bearing, Cross Shaft Left Cone	1
6535W	Bearing, Cross Shaft Left Cup	1
CR31173	Seal, Pinion	1
TL-0.5ML	Threadlocker	1
SEALANT	RTV Silicone	1

NDK506-V100		
Part No.	Description	Qty.
77375	Bearing, Diff Right & Left Hand Cone	2
77676W	Bearing, Diff Right Hand Cup	1
77676BW	Bearing, Diff Left Hand Cup	1
6460	Bearing, Pinion Head Cone	1
6420	Bearing, Pinion Head Cup	1
65225	Bearing, Pinion Tail Cone	1
65500	Bearing, Pinion Tail Cup	1
835	Bearing, Cross Shaft Right Cone	1
833W	Bearing, Cross Shaft Right Cup	1
6576	Bearing, Cross Shaft Left Cone	1
6535W	Bearing, Cross Shaft Left Cup	1
CR31173	Seal, Pinion	1

NDK507		
Part No.	Description	Qty.
47687	Bearing, Diff Right Hand Cone	1
47623A	Bearing, Diff Right Hand Cup	1
HMS16448	Bearing, Diff Left Hand Cone	1
HMS16414B	Bearing, Diff Left Hand Cup	1
HMS18437	Bearing, Pinion Head & Cross Shaft Left Cone	2
HMS18411	Bearing, Pinion Head Cup	1
HMS18411W	Bearing, Cross Shaft Left Cup	1
4955	Bearing, Pinion Tail Cone	1
492A	Bearing, Pinion Tail Cup	1
621	Bearing, Cross Shaft Right Cone	1
612	Bearing, Cross Shaft Right Cup	1
1213L	Bearing, Input Shaft DGBB	1
1211	Bearing, Thrushaft DGBB	1
SLS-1968	Seal, Input Shaft	1
SLS-1969	Seal, Thrushaft	1
SLS-1970	O-Ring	1
SLS-1712	O-Ring	1
SLS-1713	O-Ring	1
SLS-1971	O-Ring	1
SLS-1972	O-Ring	1
TL-0.5ML	Threadlocker	1
SEALANT	RTV Silicone	1

NDK507-V100		
Part No.	Description	Qty.
47687	Bearing, Diff Right Hand Cone	1
47623A	Bearing, Diff Right Hand Cup	1
HMS16448	Bearing, Diff Left Hand Cone	1
HMS16414B	Bearing, Diff Left Hand Cup	1
HMS18437	Bearing, Pinion Head & Cross Shaft Left Cone	2
HMS18411	Bearing, Pinion Head Cup	1
HMS18411W	Bearing, Cross Shaft Left Cup	1
4955	Bearing, Pinion Tail Cone	1
492A	Bearing, Pinion Tail Cup	1
621	Bearing, Cross Shaft Right Cone	1
612	Bearing, Cross Shaft Right Cup	1
1213L	Bearing, Input Shaft DGBB	1
1211	Bearing, Thrushaft DGBB	1
SLS-1968	Seal, Input Shaft	1
SLS-1969	Seal, Thrushaft	1
SLS-1970	O-Ring	1
SLS-1712	O-Ring	1
SLS-1713	O-Ring	1
SLS-1971	O-Ring	1
SLS-1972	O-Ring	1

NDK508		
Part No.	Description	Qty.
47687	Bearing, Diff Right Hand Cone	1
47623A	Bearing, Diff Right Hand Cup	1
HMS16448	Bearing, Diff Left Hand Cone	1
HMS16414B	Bearing, Diff Left Hand Cup	1
HMS18437	Bearing, Pinion Head & Cross Shaft Left Cone	2
HMS18411	Bearing, Pinion Head Cup	1
HMS18411W	Bearing, Cross Shaft Left	1
4955	Bearing, Pinion Tail Cone	1
492A	Bearing, Pinion Tail Cup	1
621	Bearing, Cross Shaft Right Cone	1
612	Bearing, Cross Shaft Right Cup	1
SLS-1965	Seal, Pinion	1
SLS-1970	O-Ring	1
SLS-1971	O-Ring	1
SLS-1972	O-Ring	1
TL-0.5ML	Threadlocker	1
SEALANT	RTV Silicone	1

NDK508-V100		
Part No.	Description	Qty.
47687	Bearing, Diff Right Hand Cone	1
47623A	Bearing, Diff Right Hand Cup	1
HMS16448	Bearing, Diff Left Hand Cone	1
HMS16414B	Bearing, Diff Left Hand Cup	1
HMS18437	Bearing, Pinion Head & Cross Shaft Left Cone	2
HMS18411	Bearing, Pinion Head Cup	1
HMS18411W	Bearing, Cross Shaft Left	1
4955	Bearing, Pinion Tail Cone	1
492A	Bearing, Pinion Tail Cup	1
621	Bearing, Cross Shaft Right Cone	1
612	Bearing, Cross Shaft Right Cup	1
SLS-1965	Seal, Pinion	1
SLS-1970	O-Ring	1
SLS-1971	O-Ring	1
SLS-1972	O-Ring	1

NDK600		
Part No.	Description	Qty.
495	Bearing, Diff Right & Left Hand Cone	2
493	Bearing, Diff Right & Left Hand Cup	2
72225C	Bearing, Pinion Head Cone	1
72487	Bearing, Pinion Head Cup	1
66212	Bearing, Pinion Tail Cone	1
66462	Bearing, Pinion Tail Cup	1
MUB1307UBM	Bearing, Pinion Nose CRB	1
SLS-1787	Seal, Pinion Shaft	1
TL-0.5ML	Threadlocker	1
SEALANT	RTV Silicone	1

NDK600-V100		
Part No.	Description	Qty.
495	Bearing, Diff Right & Left Hand Cone	2
493	Bearing, Diff Right & Left Hand Cup	2
72225C	Bearing, Pinion Head Cone	1
72487	Bearing, Pinion Head Cup	1
66212	Bearing, Pinion Tail Cone	1
66462	Bearing, Pinion Tail Cup	1
MUB1307UBM	Bearing, Pinion Nose CRB	1
SLS-1787	Seal, Pinion Shaft	1

NDK650F		
Part No.	Description	Qty.
32022X	Bearing, Diff Right Hand TRB	1
32017X	Bearing, Diff Left Hand TRB	1
F-805096	Bearing, Pinion Head TRB	1
F-805097	Bearing, Pinion Tail TRB	1
JM511945	Bearing, Input Shaft Front Cone	2
3920	Bearing, Input Shaft Front Cup	1
JLM714149	Bearing, Input Shaft Rear Cone	1
JLM714110	Bearing, Input Shaft Rear Cup	1
AXK1116	Bearing, Helical Gear Thrust NRB	1
K75X83X23	Bearing, Helical Gear Needle NRB	2
SLS-1961	Seal, Input Shaft	1
SLS-1960	Seal, Thrushaft	1
TL-0.5ML	Threadlocker	1
SEALANT	RTV Silicone	1

NDK650F-V100		
Part No.	Description	Qty.
32022X	Bearing, Diff Right Hand TRB	1
32017X	Bearing, Diff Left Hand TRB	1
F-805096	Bearing, Pinion Head TRB	1
F-805097	Bearing, Pinion Tail TRB	1
JM511945	Bearing, Input Shaft Front Cone	2
3920	Bearing, Input Shaft Front Cup	1
JLM714149	Bearing, Input Shaft Rear Cone	1
JLM714110	Bearing, Input Shaft Rear Cup	1
AXK1116	Bearing, Helical Gear Thrust NRB	1
K75X83X23	Bearing, Helical Gear Needle NRB	2
SLS-1961	Seal, Input Shaft	1
SLS-1960	Seal, Thrushaft	1

NDK650R		
Part No.	Description	Qty.
32022X	Bearing, Diff Right Hand TRB	1
32017X	Bearing, Diff Left Hand TRB	1
F-805096	Bearing, Pinion Head TRB	1
F-805097	Bearing, Pinion Tail TRB	1
SLS-1962	Seal, Pinion	1
TL-0.5ML	Threadlocker	1
SEALANT	RTV Silicone	1

NDK650R-V100		
Part No.	Description	Qty.
32022X	Bearing, Diff Right Hand TRB	1
32017X	Bearing, Diff Left Hand TRB	1
F-805096	Bearing, Pinion Head TRB	1
F-805097	Bearing, Pinion Tail TRB	1
SLS-1962	Seal, Pinion	1

NDK651		
Part No.	Description	Qty.
JW6049	Bearing, Diff Right & Left Hand Cone	2
JW6010	Bearing, Diff Right & Left Hand Cup	2
32020X	Bearing, Pinion Head	1
32014X	Bearing, Pinion Tail	1
SLS-1963	Seal, Pinion	1
TL-0.5ML	Threadlocker	1
SEALANT	RTV Silicone	1

NDK651-V100		
Part No.	Description	Qty.
JW6049	Bearing, Diff Right & Left Hand Cone	2
JW6010	Bearing, Diff Right & Left Hand Cup	2
32020X	Bearing, Pinion Head	1
32014X	Bearing, Pinion Tail	1
SLS-1963	Seal, Pinion	1

NDK900F		
Part No.	Description	Qty.
496	Bearing, Diff Right Hand Cone	1
493	Bearing, Diff Right Hand Cup	1
497*	Bearing, Diff Left Hand Cone	1
493	Bearing, Diff Left Hand Cup	1
72200C	Bearing, Pinion Head Cone	2
72487	Bearing, Pinion Head Cup	2
RU1570UM	Bearing, Pinion Nose CRB	1
29675	Bearing, Drive Gear Front & Rear Cone	2
29630	Bearing, Drive Gear Front & Rear Cup	2
31597	Bearing, Idler Gear Cone	2
6211	Bearing, Input Shaft DGGB	1
35949N	Seal, Input Shaft	1
TL-0.5ML	Threadlocker	1
SEALANT	RTV Silicone	1

NDK900F-V100		
Part No.	Description	Qty.
496	Bearing, Diff Right Hand Cone	1
493	Bearing, Diff Right Hand Cup	1
497*	Bearing, Diff Left Hand Cone	1
493	Bearing, Diff Left Hand Cup	1
72200C	Bearing, Pinion Head Cone	2
72487	Bearing, Pinion Head Cup	2
RU1570UM	Bearing, Pinion Nose CRB	1
29675	Bearing, Drive Gear Front & Rear Cone	2
29630	Bearing, Drive Gear Front & Rear Cup	2
31597	Bearing, Idler Gear Cone	2
6211	Bearing, Input Shaft DGGB	1
35949N	Seal, Input Shaft	1

\*FOR GEAR RATIOS ABOVE 4.63:1 END USER WILL NEED TO PURCHASE A 496 TO USE IN PLACE OF 497

\*FOR GEAR RATIOS ABOVE 4.63:1 END USER WILL NEED TO PURCHASE A 496 TO USE IN PLACE OF 497



NDK900FA		
Part No.	Description	Qty.
496	Bearing, Diff Right Hand Cone	1
493	Bearing, Diff Right Hand Cup	1
497*	Bearing, Diff Left Hand Cone	1
493	Bearing, Diff Left Hand Cup	1
72200C	Bearing, Pinion Head Cone	2
72487	Bearing, Pinion Head Cup	2
RU1570UM	Bearing, Pinion Nose CRB	1
29675	Bearing, Drive Gear Front & Rear Cone	2
29630	Bearing, Drive Gear Front & Rear Cup	2
31597	Bearing, Idler Gear Cone	2
31520	Bearing, Idler Gear Cup	2
6211	Bearing, Input Shaft DGBB	1
LM603049	Bearing, Thrushaft Cone	1
LM603011	Bearing, Thrushaft Cup	1
35949N	Seal, Input Shaft	1
TL-0.5ML	Threadlocker	1
SEALANT	RTV Silicone	1

\*FOR GEAR RATIOS ABOVE 4.63:1 END USER WILL NEED TO PURCHASE A 496 TO USE IN PLACE OF 497

NDK900FA-V100		
Part No.	Description	Qty.
496	Bearing, Diff Right Hand Cone	1
493	Bearing, Diff Right Hand Cup	1
497*	Bearing, Diff Left Hand Cone	1
493	Bearing, Diff Left Hand Cup	1
72200C	Bearing, Pinion Head Cone	2
72487	Bearing, Pinion Head Cup	2
RU1570UM	Bearing, Pinion Nose CRB	1
29675	Bearing, Drive Gear Front & Rear Cone	2
29630	Bearing, Drive Gear Front & Rear Cup	2
31597	Bearing, Idler Gear Cone	2
31520	Bearing, Idler Gear Cup	2
6211	Bearing, Input Shaft DGBB	1
LM603049	Bearing, Thrushaft Cone	1
LM603011	Bearing, Thrushaft Cup	1
35949N	Seal, Input Shaft	1

\*FOR GEAR RATIOS ABOVE 4.63:1 END USER WILL NEED TO PURCHASE A 496 TO USE IN PLACE OF 497

NDK2108		
Part No.	Description	Qty.
687	Bearing, Diff Right & Left Hand Cone	2
672	Bearing, Diff Right & Left Hand Cup	2
HM813844	Bearing, Pinion Head Cone	1
HM813810	Bearing, Pinion Head Cup	1
H715341	Bearing, Pinion Tail Cone	1
H715311	Bearing, Pinion Tail Cup	1
MU5208UM	Bearing, Pinion Nose CRB	1
SLS-1829	Seal, Pinion	1
TL-0.5ML	Threadlocker	1
SEALANT	RTV Silicone	1

NDK2108-V100		
Part No.	Description	Qty.
687	Bearing, Diff Right & Left Hand Cone	2
672	Bearing, Diff Right & Left Hand Cup	2
HM813844	Bearing, Pinion Head Cone	1
HM813810	Bearing, Pinion Head Cup	1
H715341	Bearing, Pinion Tail Cone	1
H715311	Bearing, Pinion Tail Cup	1
MU5208UM	Bearing, Pinion Nose CRB	1
SLS-1829	Seal, Pinion	1

NDK2111		
Part No.	Description	Qty.
395	Bearing, Diff Right & Left Hand Cone	2
394A	Bearing, Diff Right & Left Hand Cup	2
M903345	Bearing, Pinion Head Cone	1
M903310	Bearing, Pinion Head Cup	1
44143	Bearing, Pinion Tail Cone	1
44348	Bearing, Pinion Tail Cup	1
MU1305TDM	Bearing, Pinion Nose CRB	1
SLS-1850*	Seal, Pinion	1
SLS-1851**	Seal, Pinion	1
TL-0.5ML	Threadlocker	1
SEALANT	RTV Silicone	1

\* LINE ITEMS WITH \*\* USE WITH AXLE C100 & \*\*\* USE WITH AXLE C102 & C103

NDK2111-V100		
Part No.	Description	Qty.
395	Bearing, Diff Right & Left Hand Cone	2
394A	Bearing, Diff Right & Left Hand Cup	2
M903345	Bearing, Pinion Head Cone	1
M903310	Bearing, Pinion Head Cup	1
44143	Bearing, Pinion Tail Cone	1
44348	Bearing, Pinion Tail Cup	1
MU1305TDM	Bearing, Pinion Nose CRB	1
SLS-1850*	Seal, Pinion	1
SLS-1851**	Seal, Pinion	1

\* LINE ITEMS WITH \*\* USE WITH AXLE C100 & \*\*\* USE WITH AXLE C102 & C103

NDK4095		
Part No.	Description	Qty.
47890	Bearing, Diff Right & Left Hand Cone	2
47820	Bearing, Diff Right & Left Hand Cup	2
H715343	Bearing, Pinion Head Cone	1
H715311	Bearing, Pinion Head Cup	1
65237	Bearing, Pinion Tail Cone	1
65500	Bearing, Pinion Tail Cup	1
JLM714149	Bearing, Inter Diff Bearing Cone	1
JLM714110	Bearing, Inter Diff Bearing Cup	1
JH211749	Bearing, Input Shaft Cup	1
JH211710	Bearing, Input Shaft Cone	1
LM104949	Bearing, Output Shaft Cup	2
JLM104910	Bearing, Output Shaft Cone	2
SLS-1666	Seal, Input Shaft	1
SLS-1805	Seal, Thrushaft	1
TL-0.5ML	Threadlocker	1
SEALANT	RTV Silicone	1

NDK4095-V100		
Part No.	Description	Qty.
47890	Bearing, Diff Right & Left Hand Cone	2
47820	Bearing, Diff Right & Left Hand Cup	2
H715343	Bearing, Pinion Head Cone	1
H715311	Bearing, Pinion Head Cup	1
65237	Bearing, Pinion Tail Cone	1
65500	Bearing, Pinion Tail Cup	1
JLM714149	Bearing, Inter Diff Bearing Cone	1
JLM714110	Bearing, Inter Diff Bearing Cup	1
JH211749	Bearing, Input Shaft Cup	1
JH211710	Bearing, Input Shaft Cone	1
LM104949	Bearing, Output Shaft Cup	2
JLM104910	Bearing, Output Shaft Cone	2
SLS-1666	Seal, Input Shaft	1
SLS-1805	Seal, Thrushaft	1

NDK4100		
Part No.	Description	Qty.
47890	Bearing, Diff Right & Left Hand Cone	2
47820	Bearing, Diff Right & Left Hand Cup	2
H715343	Bearing, Pinion Head Cone	1
H715311	Bearing, Pinion Head Cup	1
65237	Bearing, Pinion Tail Cone	1
65500	Bearing, Pinion Tail Cup	1
JLM714149	Bearing, Inter Diff Bearing Cone	1
JLM714110	Bearing, Inter Diff Bearing Cup	1
JH211749	Bearing, Input Shaft Cup	1
JH211710	Bearing, Input Shaft Cone	1
6210	Bearing, Thrushaft DGBB	1
SLS-1839	O-Ring	1
SLS-1666	Seal, Input Shaft	1
SLS-1808	Seal, Thrushaft	1
TL-0.5ML	Threadlocker	1
SEALANT	RTV Silicone	1

NDK4100-V100		
Part No.	Description	Qty.
47890	Bearing, Diff Right & Left Hand Cone	2
47820	Bearing, Diff Right & Left Hand Cup	2
H715343	Bearing, Pinion Head Cone	1
H715311	Bearing, Pinion Head Cup	1
65237	Bearing, Pinion Tail Cone	1
65500	Bearing, Pinion Tail Cup	1
JLM714149	Bearing, Inter Diff Bearing Cone	1
JLM714110	Bearing, Inter Diff Bearing Cup	1
JH211749	Bearing, Input Shaft Cup	1
JH211710	Bearing, Input Shaft Cone	1
6210	Bearing, Thrushaft DGBB	1
SLS-1839	O-Ring	1
SLS-1666	Seal, Input Shaft	1
SLS-1808	Seal, Thrushaft	1

NDK4105		
Part No.	Description	Qty.
47890	Bearing, Diff Right & Left Hand Cone	2
47820	Bearing, Diff Right & Left Hand Cup	2
H715343	Bearing, Pinion Head Cone	1
H715334	Bearing, Pinion Tail Cone	1
H715311	Bearing, Pinion Head & Tail Cup	2
MU1308UM	Bearing, Pinion Nose	1
SLS-1830	Seal, Pinion	1
TL-0.5ML	Threadlocker	1
SEALANT	RTV Silicone	1

NDK4105-V100		
Part No.	Description	Qty.
47890	Bearing, Diff Right & Left Hand Cone	2
47820	Bearing, Diff Right & Left Hand Cup	2
H715343	Bearing, Pinion Head Cone	1
H715334	Bearing, Pinion Tail Cone	1
H715311	Bearing, Pinion Head & Tail Cup	2
MU1308UM	Bearing, Pinion Nose	1
SLS-1830	Seal, Pinion	1

NDK4125		
Part No.	Description	Qty.
598	Bearing, Diff Right Hand Cone	1
592A	Bearing, Diff Right Hand Cup	1
52387	Bearing, Diff Left Hand Cone	1
52618	Bearing, Diff Left Hand Cup	1
78250AC	Bearing, Pinion Head & Tail Cone	2
78551	Bearing, Pinion Head & Tail Cup	2
MUB1309UM	Bearing, Pinion Nose CRB	1
HM813841	Bearing, Input Shaft Front Cone	1
HM813810	Bearing, Input Shaft Front Cup	1
JM515649	Bearing, Output Shaft Rear Cone	1
JM515610	Bearing, Output Shaft Rear Cup	1
385A	Bearing, Thrushaft Cone	2
382A	Bearing, Thrushaft Cup	2
3204	Bearing, Oil Pump Idler Gear - ACBB	1
32385	Seal, Input Shaft	1
29925	Seal, Thrushaft	1
TL-0.5ML	Threadlocker	1
SEALANT	RTV Silicone	1

NDK4125-V100		
Part No.	Description	Qty.
598	Bearing, Diff Right Hand Cone	1
592A	Bearing, Diff Right Hand Cup	1
52387	Bearing, Diff Left Hand Cone	1
52618	Bearing, Diff Left Hand Cup	1
78250AC	Bearing, Pinion Head & Tail Cone	2
78551	Bearing, Pinion Head & Tail Cup	2
MUB1309UM	Bearing, Pinion Nose CRB	1
HM813841	Bearing, Input Shaft Front Cone	1
HM813810	Bearing, Input Shaft Front Cup	1
JM515649	Bearing, Output Shaft Rear Cone	1
JM515610	Bearing, Output Shaft Rear Cup	1
385A	Bearing, Thrushaft Cone	2
382A	Bearing, Thrushaft Cup	2
3204	Bearing, Oil Pump Idler Gear - ACBB	1
32385	Seal, Input Shaft	1
29925	Seal, Thrushaft	1

NDK4130		
Part No.	Description	Qty.
598	Bearing, Diff Right Hand Cone	1
592A	Bearing, Diff Right Hand Cup	1
52387	Bearing, Diff Left Hand Cone	1
52618	Bearing, Diff Left Hand Cup	1
H715343	Bearing, Pinion Head Cone	1
H715334	Bearing, Pinion Tail Cone	1
H715311	Bearing, Pinion Head & Tail Cup	2
MUC1309UM	Bearing, Pinion Nose	1
SLS-1788	Seal, Pinion	1
TL-0.5ML	Threadlocker	1
SEALANT	RTV Silicone	1

NDK4130-V100		
Part No.	Description	Qty.
598	Bearing, Diff Right Hand Cone	1
592A	Bearing, Diff Right Hand Cup	1
52387	Bearing, Diff Left Hand Cone	1
52618	Bearing, Diff Left Hand Cup	1
H715343	Bearing, Pinion Head Cone	1
H715334	Bearing, Pinion Tail Cone	1
H715311	Bearing, Pinion Head & Tail Cup	2
MUC1309UM	Bearing, Pinion Nose	1
SLS-1788	Seal, Pinion	1

NDK4135		
Part No.	Description	Qty.
598	Bearing, Diff Right Hand Cone	1
592A	Bearing, Diff Right Hand Cup	1
52387	Bearing, Diff Left Hand Cone	1
52618	Bearing, Diff Left Hand Cup	1
78250AC	Bearing, Pinion Head & Tail Cone	2
78551	Bearing, Pinion Head & Tail Cup	2
MUB1309UM	Bearing, Pinion Nose CRB	1
HM813844	Bearing, Input Shaft Front Cone	1
HM813810	Bearing, Input Shaft Front Cup	1
JM515649	Bearing, Output Shaft Rear Cone	1
JM515610	Bearing, Output Shaft Rear Cup	1
385A	Bearing, Thrushaft Cone	2
382A	Bearing, Thrushaft Cup	2
LM11949-90013	Bearing, Oil Pump Idler Gear - TRB Assembly	1
R945007	Seal, Input Shaft	1
A1205N1496	Seal, Thrushaft	1
TL-0.5ML	Threadlocker	1
SEALANT	RTV Silicone	1

NDK4135-V100		
Part No.	Description	Qty.
598	Bearing, Diff Right Hand Cone	1
592A	Bearing, Diff Right Hand Cup	1
52387	Bearing, Diff Left Hand Cone	1
52618	Bearing, Diff Left Hand Cup	1
78250AC	Bearing, Pinion Head & Tail Cone	2
78551	Bearing, Pinion Head & Tail Cup	2
MUB1309UM	Bearing, Pinion Nose CRB	1
HM813844	Bearing, Input Shaft Front Cone	1
HM813810	Bearing, Input Shaft Front Cup	1
JM515649	Bearing, Output Shaft Rear Cone	1
JM515610	Bearing, Output Shaft Rear Cup	1
385A	Bearing, Thrushaft Cone	2
382A	Bearing, Thrushaft Cup	2
LM11949-90013	Bearing, Oil Pump Idler Gear - TRB Assembly	1
R945007	Seal, Input Shaft	1
A1205N1496	Seal, Thrushaft	1

NDK4140		
Part No.	Description	Qty.
598	Bearing, Diff Right Hand Cone	1
592A	Bearing, Diff Right Hand Cup	1
52387	Bearing, Diff Left Hand Cone	1
52618	Bearing, Diff Left Hand Cup	1
78250AC	Bearing, Pinion Head & Tail Cone	2
78551	Bearing, Pinion Head & Tail Cup	2
MUB1309UM	Bearing, Pinion Nose CRB	1
HM813844	Bearing, Input Shaft Front Cone	1
HM813810	Bearing, Input Shaft Front Cup	1
JM515649	Bearing, Output Shaft Rear Cone	1
JM515610	Bearing, Output Shaft Rear Cup	1
385A	Bearing, Thrushaft Cone	2
382A	Bearing, Thrushaft Cup	2
LM11949-90013	Bearing, Oil Pump Idler Gear - TRB Assembly	1
R945007	Seal, Input Shaft	1
A1205C1927	Seal, Thrushaft	1
TL-0.5ML	Threadlocker	1
SEALANT	RTV Silicone	1

NDK4140-V100		
Part No.	Description	Qty.
598	Bearing, Diff Right Hand Cone	1
592A	Bearing, Diff Right Hand Cup	1
52387	Bearing, Diff Left Hand Cone	1
52618	Bearing, Diff Left Hand Cup	1
78250AC	Bearing, Pinion Head & Tail Cone	2
78551	Bearing, Pinion Head & Tail Cup	2
MUB1309UM	Bearing, Pinion Nose CRB	1
HM813844	Bearing, Input Shaft Front Cone	1
HM813810	Bearing, Input Shaft Front Cup	1
JM515649	Bearing, Output Shaft Rear Cone	1
JM515610	Bearing, Output Shaft Rear Cup	1
385A	Bearing, Thrushaft Cone	2
382A	Bearing, Thrushaft Cup	2
LM11949-90013	Bearing, Oil Pump Idler Gear - TRB Assembly	1
R945007	Seal, Input Shaft	1
A1205C1927	Seal, Thrushaft	1

NDK4145		
Part No.	Description	Qty.
598	Bearing, Diff Right Hand Cone	1
592A	Bearing, Diff Right Hand Cup	1
52387	Bearing, Diff Left Hand Cone	1
52618	Bearing, Diff Left Hand Cup	1
78250AC	Bearing, Pinion Head & Tail Cone	2
78551	Bearing, Pinion Head & Tail Cup	2
MUC1309UM	Bearing, Pinion Nose CRB	1
HM813844	Bearing, Input Shaft Front Cone	1
HM813810	Bearing, Input Shaft Front Cup	1
JM515649	Bearing, Output Shaft Rear Cone	1
JM515610	Bearing, Output Shaft Rear Cup	1
385A	Bearing, Thrushaft Cone	2
382A	Bearing, Thrushaft Cup	2
LM11949-90013	Bearing, Oil Pump Idler Gear - TRB Assembly	1
R945007	Seal, Input Shaft	1
A1205N1927	Seal, Thrushaft	1
TL-0.5ML	Threadlocker	1
SEALANT	RTV Silicone	1

NDK4145-V100		
Part No.	Description	Qty.
598	Bearing, Diff Right Hand Cone	1
592A	Bearing, Diff Right Hand Cup	1
52387	Bearing, Diff Left Hand Cone	1
52618	Bearing, Diff Left Hand Cup	1
78250AC	Bearing, Pinion Head & Tail Cone	2
78551	Bearing, Pinion Head & Tail Cup	2
MUC1309UM	Bearing, Pinion Nose CRB	1
HM813844	Bearing, Input Shaft Front Cone	1
HM813810	Bearing, Input Shaft Front Cup	1
JM515649	Bearing, Output Shaft Rear Cone	1
JM515610	Bearing, Output Shaft Rear Cup	1
385A	Bearing, Thrushaft Cone	2
382A	Bearing, Thrushaft Cup	2
LM11949-90013	Bearing, Oil Pump Idler Gear - TRB Assembly	1
R945007	Seal, Input Shaft	1
A1205N1927	Seal, Thrushaft	1

NDK4150		
Part No.	Description	Qty.
598	Bearing, Diff Right Hand Cone	1
592A	Bearing, Diff Right Hand Cup	1
52387	Bearing, Diff Left Hand Cone	1
52618	Bearing, Diff Left Hand Cup	1
H715343	Bearing, Pinion Head Cone	1
H715334	Bearing, Pinion Tail Cone	1
H715311	Bearing, Pinion Head & Tail Cup	2
MUB1309UM	Bearing, Pinion Nose CRB	1
SLS-1831	Seal, Pinion	1
TL-0.5ML	Threadlocker	1
SEALANT	RTV Silicone	1

NDK4150-V100		
Part No.	Description	Qty.
598	Bearing, Diff Right Hand Cone	1
592A	Bearing, Diff Right Hand Cup	1
52387	Bearing, Diff Left Hand Cone	1
52618	Bearing, Diff Left Hand Cup	1
H715343	Bearing, Pinion Head Cone	1
H715334	Bearing, Pinion Tail Cone	1
H715311	Bearing, Pinion Head & Tail Cup	2
MUB1309UM	Bearing, Pinion Nose CRB	1
SLS-1831	Seal, Pinion	1

NDK4155		
Part No.	Description	Qty.
598	Bearing, Diff Right Hand Cone	1
592A	Bearing, Diff Right Hand Cup	1
52387	Bearing, Diff Left Hand Cone	1
52618	Bearing, Diff Left Hand Cup	1
78250AC	Bearing, Pinion Head & Tail Cone	2
78551	Bearing, Pinion Head & Tail Cup	2
MUB1309UM	Bearing, Pinion Nose CRB	1
496	Bearing, Input Shaft Front Cone	1
493	Bearing, Input Shaft Front Cup	1
29685	Bearing, Input Shaft Rear Cone	1
29620	Bearing, Input Shaft Rear Cup	1
SLS-1667	Seal, Thrushaft	1
TL-0.5ML	Threadlocker	1
SEALANT	RTV Silicone	1

NDK4155-V100		
Part No.	Description	Qty.
598	Bearing, Diff Right Hand Cone	1
592A	Bearing, Diff Right Hand Cup	1
52387	Bearing, Diff Left Hand Cone	1
52618	Bearing, Diff Left Hand Cup	1
78250AC	Bearing, Pinion Head & Tail Cone	2
78551	Bearing, Pinion Head & Tail Cup	2
MUB1309UM	Bearing, Pinion Nose CRB	1
496	Bearing, Input Shaft Front Cone	1
493	Bearing, Input Shaft Front Cup	1
29685	Bearing, Input Shaft Rear Cone	1
29620	Bearing, Input Shaft Rear Cup	1
SLS-1667	Seal, Thrushaft	1

NDK4155A		
Part No.	Description	Qty.
598	Bearing, Diff Right Hand Cone	1
592A	Bearing, Diff Right Hand Cup	1
52387	Bearing, Diff Left Hand Cone	1
52618	Bearing, Diff Left Hand Cup	1
78250AC	Bearing, Pinion Head & Tail Cone	2
78551	Bearing, Pinion Head & Tail Cup	2
MUC1309UM	Bearing, Pinion Nose CRB	1
496	Bearing, Input Shaft Front Cone	1
493	Bearing, Input Shaft Front Cup	1
29685	Bearing, Input Shaft Rear Cone	1
29620	Bearing, Input Shaft Rear Cup	1
SLS-1667	Seal, Thrushaft	1
TL-0.5ML	Threadlocker	1
SEALANT	RTV Silicone	1

NDK4155A-V100		
Part No.	Description	Qty.
598	Bearing, Diff Right Hand Cone	1
592A	Bearing, Diff Right Hand Cup	1
52387	Bearing, Diff Left Hand Cone	1
52618	Bearing, Diff Left Hand Cup	1
78250AC	Bearing, Pinion Head & Tail Cone	2
78551	Bearing, Pinion Head & Tail Cup	2
MUC1309UM	Bearing, Pinion Nose CRB	1
496	Bearing, Input Shaft Front Cone	1
493	Bearing, Input Shaft Front Cup	1
29685	Bearing, Input Shaft Rear Cone	1
29620	Bearing, Input Shaft Rear Cup	1
SLS-1667	Seal, Thrushaft	1

NDK4180		
Part No.	Description	Qty.
581	Bearing, Diff Right & Left Hand Cone	2
572	Bearing, Diff Right & Left Hand Cup	2
42350	Bearing, Pinion Head Cone	1
42584	Bearing, Pinion Head Cup	1
497	Bearing, Pinion Tail Cone	1
493	Bearing, Pinion Tail Cup	1
MR1212EL	Bearing, Pinion Nose CRB	1
66225	Bearing, Cross Shaft Right Bearing Cone	2
66462	Bearing, Cross Shaft Right Bearing Cup	2
MU1218TDHM	Bearing, Cross Shaft Left CRB	1
5211W	Bearing, Cross Shaft Left Bearing DRBB	1
6210	Bearing, Thrushaft DGBB	1
SLS-1786	Seal, Input Shaft	1
SLS-1808	Seal, Thrushaft	1
TL-0.5ML	Threadlocker	1
SEALANT	RTV Silicone	1

NDK4180-V100		
Part No.	Description	Qty.
581	Bearing, Diff Right & Left Hand Cone	2
572	Bearing, Diff Right & Left Hand Cup	2
42350	Bearing, Pinion Head Cone	1
42584	Bearing, Pinion Head Cup	1
497	Bearing, Pinion Tail Cone	1
493	Bearing, Pinion Tail Cup	1
MR1212EL	Bearing, Pinion Nose CRB	1
66225	Bearing, Cross Shaft Right Bearing Cone	2
66462	Bearing, Cross Shaft Right Bearing Cup	2
MU1218TDHM	Bearing, Cross Shaft Left CRB	1
5211W	Bearing, Cross Shaft Left Bearing DRBB	1
6210	Bearing, Thrushaft DGBB	1
SLS-1786	Seal, Input Shaft	1
SLS-1808	Seal, Thrushaft	1

NDK4310		
Part No.	Description	Qty.
3994	Bearing, Diff Right & Left Hand Cone	2
JM511910	Bearing, Diff Right & Left Hand Cup	2
HM903249A	Bearing, Pinion Head & Tail Cone	2
HM903216	Bearing, Pinion Head & Tail Cup	2
MUB1305UDM	Bearing, Pinion Nose CRB	1
SLS-1771	Seal, Pinion Shaft	1
TL-0.5ML	Threadlocker	1
SEALANT	RTV Silicone	1

NDK4310-V100		
Part No.	Description	Qty.
3994	Bearing, Diff Right & Left Hand Cone	2
JM511910	Bearing, Diff Right & Left Hand Cup	2
HM903249A	Bearing, Pinion Head & Tail Cone	2
HM903216	Bearing, Pinion Head & Tail Cup	2
MUB1305UDM	Bearing, Pinion Nose CRB	1
SLS-1771	Seal, Pinion Shaft	1

NDK4315		
Part No.	Description	Qty.
3994	Bearing, Diff Right & Left Hand Cone	2
JM511910	Bearing, Diff Right & Left Hand Cup	2
HM803149	Bearing, Pinion Head & Tail Cone	2
HM803110	Bearing, Pinion Head & Tail Cup	2
MUB1305UDM	Bearing, Pinion Nose CRB	1
SLS-1966	Seal, Pinion	1
TL-0.5ML	Threadlocker	1
SEALANT	RTV Silicone	1

NDK4315-V100		
Part No.	Description	Qty.
3994	Bearing, Diff Right & Left Hand Cone	2
JM511910	Bearing, Diff Right & Left Hand Cup	2
HM803149	Bearing, Pinion Head & Tail Cone	2
HM803110	Bearing, Pinion Head & Tail Cup	2
MUB1305UDM	Bearing, Pinion Nose CRB	1
SLS-1966	Seal, Pinion	1

NDK4325		
Part No.	Description	Qty.
33275	Bearing, Diff Right Hand Cone	1
33472	Bearing, Diff Right Hand Cup	1
47490	Bearing, Diff Left Hand Cone	1
47420	Bearing, Diff Left Hand Cup	1
HM807044	Bearing, Pinion Head Cone	1
HM807010	Bearing, Pinion Head Cup	1
M804049	Bearing, Pinion Tail Cone	1
M804010	Bearing, Pinion Tail Cup	1
RU1570UM	Bearing, Pinion Nose CRB	1
SLS-1959	Seal, Pinion	1
TL-0.5ML	Threadlocker	1
SEALANT	RTV Silicone	1

NDK4325-V100		
Part No.	Description	Qty.
33275	Bearing, Diff Right Hand Cone	1
33472	Bearing, Diff Right Hand Cup	1
47490	Bearing, Diff Left Hand Cone	1
47420	Bearing, Diff Left Hand Cup	1
HM807044	Bearing, Pinion Head Cone	1
HM807010	Bearing, Pinion Head Cup	1
M804049	Bearing, Pinion Tail Cone	1
M804010	Bearing, Pinion Tail Cup	1
RU1570UM	Bearing, Pinion Nose CRB	1
SLS-1959	Seal, Pinion	1

NDK4330		
Part No.	Description	Qty.
JLM714149	Bearing, Diff Right & Left Hand Cone	2
JLM714110	Bearing, Diff Right & Left Hand Cup	2
55200C	Bearing, Pinion Head Cone	1
55437	Bearing, Pinion Head Cup	1
HM804846	Bearing, Pinion Tail Cone	1
HM804810	Bearing, Pinion Tail Cup	1
RU1570UM	Bearing, Pinion Nose CRB	1
SLS-1804	Seal, Pinion Shaft	1
TL-0.5ML	Threadlocker	1
SEALANT	RTV Silicone	1

NDK4330-V100		
Part No.	Description	Qty.
JLM714149	Bearing, Diff Right & Left Hand Cone	2
JLM714110	Bearing, Diff Right & Left Hand Cup	2
55200C	Bearing, Pinion Head Cone	1
55437	Bearing, Pinion Head Cup	1
HM804846	Bearing, Pinion Tail Cone	1
HM804810	Bearing, Pinion Tail Cup	1
RU1570UM	Bearing, Pinion Nose CRB	1
SLS-1804	Seal, Pinion Shaft	1

NDK4375		
Part No.	Description	Qty.
JM716649	Bearing, Diff Right Cone	1
JM716610	Bearing, Diff Right Cup	1
JP12049	Bearing, Diff Left Cone	1
JP12010	Bearing, Diff Left Cup	1
78225C	Bearing, Pinion Head Cone	1
78551	Bearing, Pinion Head Cup	1
55206C	Bearing, Pinion Tail Cone	1
55437	Bearing, Pinion Tail Cup	1
MUB1307UBM	Bearing, Pinion Nose CRB	1
SLS-1711	Seal, Pinion	1
TL-0.5ML	Threadlocker	1
SEALANT	RTV Silicone	1

NDK4375-V100		
Part No.	Description	Qty.
JM716649	Bearing, Diff Right Cone	1
JM716610	Bearing, Diff Right Cup	1
JP12049	Bearing, Diff Left Cone	1
JP12010	Bearing, Diff Left Cup	1
78225C	Bearing, Pinion Head Cone	1
78551	Bearing, Pinion Head Cup	1
55206C	Bearing, Pinion Tail Cone	1
55437	Bearing, Pinion Tail Cup	1
MUB1307UBM	Bearing, Pinion Nose CRB	1
SLS-1711	Seal, Pinion	1

NDK4390		
Part No.	Description	Qty.
JM716649	Bearing, Diff Right Hand Cone	1
JM716610	Bearing, Diff Right Hand Cup	1
JP10049	Bearing, Diff Left Hand Cone	1
JP10010A	Bearing, Diff Left Hand Cup	1
72212C	Bearing, Pinion Head Cone	1
72487	Bearing, Pinion Head Cup	1
55206C	Bearing, Pinion Tail Cone	1
55437	Bearing, Pinion Tail Cup	1
RU1570UM	Bearing, Pinion Nose CRB	1
A1-1205-Z-2730	Seal, Pinion	1
TL-0.5ML	Threadlocker	1
SEALANT	RTV Silicone	1

NDK4390-V100		
Part No.	Description	Qty.
JM716649	Bearing, Diff Right Hand Cone	1
JM716610	Bearing, Diff Right Hand Cup	1
JP10049	Bearing, Diff Left Hand Cone	1
JP10010A	Bearing, Diff Left Hand Cup	1
72212C	Bearing, Pinion Head Cone	1
72487	Bearing, Pinion Head Cup	1
55206C	Bearing, Pinion Tail Cone	1
55437	Bearing, Pinion Tail Cup	1
RU1570UM	Bearing, Pinion Nose CRB	1
A1-1205-Z-2730	Seal, Pinion	1

NDK4395		
Part No.	Description	Qty.
JM716649	Bearing, Diff Right & Left Hand Cone	2
JM716610	Bearing, Diff Right & Left Hand Cup	2
H715334	Bearing, Pinion Head Cone	1
H715311	Bearing, Pinion Head Cup	1
72212C	Bearing, Pinion Tail Cone	1
72487	Bearing, Pinion Tail Cup	1
JM511946	Bearing, Input Shaft Front Cone	1
3920	Bearing, Input Shaft Front Cup	1
JLM710949	Bearing, Input Shaft Rear Cone	1
JLM710910	Bearing, Input Shaft Rear Cup	1
LM104949	Bearing, Output Shaft Cone	2
JLM104910	Bearing, Output Shaft Cup	2
A11205Y2729	Seal, Input Shaft Pinion & Thrushaft	2
5X1094	O-Ring	2
TL-0.5ML	Threadlocker	1
SEALANT	RTV Silicone	1

NDK4395-V100		
Part No.	Description	Qty.
JM716649	Bearing, Diff Right & Left Hand Cone	2
JM716610	Bearing, Diff Right & Left Hand Cup	2
H715334	Bearing, Pinion Head Cone	1
H715311	Bearing, Pinion Head Cup	1
72212C	Bearing, Pinion Tail Cone	1
72487	Bearing, Pinion Tail Cup	1
JM511946	Bearing, Input Shaft Front Cone	1
3920	Bearing, Input Shaft Front Cup	1
JLM710949	Bearing, Input Shaft Rear Cone	1
JLM710910	Bearing, Input Shaft Rear Cup	1
LM104949	Bearing, Output Shaft Cone	2
JLM104910	Bearing, Output Shaft Cup	2
A11205Y2729	Seal, Input Shaft Pinion & Thrushaft	2
5X1094	O-Ring	2

NDK4396		
Part No.	Description	Qty.
JM716649	Bearing, Diff Right & Left Hand Cone	2
JM716610	Bearing, Diff Right & Left Hand Cup	2
H715334	Bearing, Pinion Head Cone	1
H715311	Bearing, Pinion Head Cup	1
72212C	Bearing, Pinion Tail Cone	1
72487	Bearing, Pinion Tail Cup	1
JM511945	Bearing, Input Shaft Front Cone	1
3920	Bearing, Input Shaft Front Cup	1
JLM710949	Bearing, Input Shaft Rear Cone	1
JLM710910	Bearing, Input Shaft Rear Cup	1
LM104949	Bearing, Output Shaft Cup Cone	2
JLM104910	Bearing, Output Shaft Cup	2
A11205X2728-NTN	Seal, Input Shaft	1
A11205Y2729-NTN	Seal, Thrushaft	1
5X1034	O-Ring	1
5X1343	O-Ring	1
TL-0.5ML	Threadlocker	1
SEALANT	RTV Silicone	1

NDK4396-V100		
Part No.	Description	Qty.
JM716649	Bearing, Diff Right & Left Hand Cone	2
JM716610	Bearing, Diff Right & Left Hand Cup	2
H715334	Bearing, Pinion Head Cone	1
H715311	Bearing, Pinion Head Cup	1
72212C	Bearing, Pinion Tail Cone	1
72487	Bearing, Pinion Tail Cup	1
JM511945	Bearing, Input Shaft Front Cone	1
3920	Bearing, Input Shaft Front Cup	1
JLM710949	Bearing, Input Shaft Rear Cone	1
JLM710910	Bearing, Input Shaft Rear Cup	1
A11205X2728-NTN	Seal, Input Shaft	1
5X1034	O-Ring	1
5X1343	O-Ring	1

NDK4400		
Part No.	Description	Qty.
JM716649	Bearing, Diff Right Hand Cone	1
JM716610	Bearing, Diff Right Hand Cup	1
JM716649	Bearing, Diff Left Hand Cone	1
JM716610	Bearing, Diff Left Hand Cup	1
72212C	Bearing, Pinion Head Cone	1
72487	Bearing, Pinion Head Cup	1
55206C	Bearing, Pinion Tail Cone	1
55437	Bearing, Pinion Tail Cup	1
RU1570UM	Bearing, Pinion Nose	1
A11205Z2730-NTN	Seal Pinion	1
MSC-1671	RTV Silicone	1

NDK4400-V100		
Part No.	Description	Qty.
JM716649	Bearing, Diff Right Hand Cone	1
JM716610	Bearing, Diff Right Hand Cup	1
JM716649	Bearing, Diff Left Hand Cone	1
JM716610	Bearing, Diff Left Hand Cup	1
72212C	Bearing, Pinion Head Cone	1
72487	Bearing, Pinion Head Cup	1
55206C	Bearing, Pinion Tail Cone	1
55437	Bearing, Pinion Tail Cup	1
RU1570UM	Bearing, Pinion Nose	1
A11205Z2730-NTN	Seal Pinion	1



NDK4405		
Part No.	Description	Qty.
JM716649	Bearing, Diff Right Hand Cone	1
JM716610	Bearing, Diff Right Hand Cup	1
JP10049	Bearing, Diff Left Hand Cone	1
JP10010A	Bearing, Diff Left Hand Cup	1
H715334	Bearing, Pinion Head Cone	1
H715311	Bearing, Pinion Head Cup	1
72212C	Bearing, Pinion Tail Cone	1
72487	Bearing, Pinion Tail Cup	1
JMS11946*	Bearing, Input Shaft Front Cone	1
JMS11910*	Bearing, Input Shaft Front Cup	1
3920*	Bearing, Input Shaft Front Cup	1
JLM710949	Bearing, Input Shaft Rear Cone	1
JLM710910	Bearing, Input Shaft Rear Cup	1
LM104949	Bearing, Output Shaft Cone	2
JLM104910	Bearing, Output Shaft Cup	2
5X1034	O-Ring	2
A11205Y2729	Seal, Input Shaft Pinion & Thrushaft	2
TL-0.5ML	Threadlocker	1
SEALANT	RTV Silicone	1

\*JMS11910 AND 3920 BOTH GO WITH JMS1194. END USER TO DETERMINE WHICH CUP TO USE BASED ON AXLE

NDK4405-V100		
Part No.	Description	Qty.
JM716649	Bearing, Diff Right Hand Cone	1
JM716610	Bearing, Diff Right Hand Cup	1
JP10049	Bearing, Diff Left Hand Cone	1
JP10010A	Bearing, Diff Left Hand Cup	1
H715334	Bearing, Pinion Head Cone	1
H715311	Bearing, Pinion Head Cup	1
72212C	Bearing, Pinion Tail Cone	1
72487	Bearing, Pinion Tail Cup	1
JMS11946*	Bearing, Input Shaft Front Cone	1
JMS11910*	Bearing, Input Shaft Front Cup	1
3920*	Bearing, Input Shaft Front Cup	1
JLM710949	Bearing, Input Shaft Rear Cone	1
JLM710910	Bearing, Input Shaft Rear Cup	1
LM104949	Bearing, Output Shaft Cone	2
JLM104910	Bearing, Output Shaft Cup	2
5X1034	O-Ring	2
A11205Y2729	Seal, Input Shaft Pinion & Thrushaft	2

\*JMS11910 AND 3920 BOTH GO WITH JMS1194. END USER TO DETERMINE WHICH CUP TO USE BASED ON AXLE

NDK4406		
Part No.	Description	Qty.
JM716649	Bearing, Diff Right Hand Cone	1
JM716610	Bearing, Diff Right Hand Cup	1
JP10049	Bearing, Diff Left Hand Cone	1
JP10010A	Bearing, Diff Left Hand Cup	1
H715334	Bearing, Pinion Head Cone	1
H715311	Bearing, Pinion Head Cup	1
72212C	Bearing, Pinion Tail Cone	1
72487	Bearing, Pinion Tail Cup	1
JMS11945	Bearing, Input Shaft Front Cone	1
3920	Bearing, Input Shaft Front Cup	1
JLM710949	Bearing, Input Shaft Rear Cone	1
JLM710910	Bearing, Input Shaft Rear Cup	1
LM104949	Bearing, Output Shaft Cone	2
JLM104910	Bearing, Output Shaft Cup	2
5X1034	O-Ring	2
A11205Y2729	Seal, Thrushaft	1
A11205Y2728	Seal, Input Shaft	1
TL-0.5ML	Threadlocker	1
SEALANT	RTV Silicone	1

NDK4406-V100		
Part No.	Description	Qty.
JM716649	Bearing, Diff Right Hand Cone	1
JM716610	Bearing, Diff Right Hand Cup	1
JP10049	Bearing, Diff Left Hand Cone	1
JP10010A	Bearing, Diff Left Hand Cup	1
H715334	Bearing, Pinion Head Cone	1
H715311	Bearing, Pinion Head Cup	1
72212C	Bearing, Pinion Tail Cone	1
72487	Bearing, Pinion Tail Cup	1
JMS11945	Bearing, Input Shaft Front Cone	1
3920	Bearing, Input Shaft Front Cup	1
JLM710949	Bearing, Input Shaft Rear Cone	1
JLM710910	Bearing, Input Shaft Rear Cup	1
LM104949	Bearing, Output Shaft Cone	2
JLM104910	Bearing, Output Shaft Cup	2
5X1034	O-Ring	2
A11205Y2729	Seal, Thrushaft	1
A11205Y2728	Seal, Input Shaft	1

NDK4415		
Part No.	Description	Qty.
32021	Bearing, Diff Right & Left Hand TRB	2
9278	Bearing, Pinion Head Cone	1
9220	Bearing, Pinion Head Cup	1
HM813843	Bearing, Pinion Tail Cone	1
HM813810	Bearing, Pinion Tail Cup	1
MRC1308XECX (EQUIV)	Bearing, Pinion	1
A1205Q2591	Seal, Input Shaft	1
TL-0.5ML	Threadlocker	1
SEALANT	RTV Silicone	1

NDK4415-V100		
Part No.	Description	Qty.
32021	Bearing, Diff Right & Left Hand TRB	2
9278	Bearing, Pinion Head Cone	1
9220	Bearing, Pinion Head Cup	1
HM813843	Bearing, Pinion Tail Cone	1
HM813810	Bearing, Pinion Tail Cup	1
MRC1308XECX (EQUIV)	Bearing, Pinion	1
A1205Q2591	Seal, Input Shaft	1

NDK4420		
Part No.	Description	Qty.
32021	Bearing, Diff Right & Left Hand TRB	2
H715343	Bearing, Pinion Head Cone	1
H715311	Bearing, Pinion Head Cup	1
65237	Bearing, Pinion Tail Cone	1
65500	Bearing, Pinion Tail Cup	1
HM813843	Bearing, Input Shaft Front Cone	1
HM813810	Bearing, Input Shaft Front Cup	1
JLM714149	Bearing, Input Shaft Rear Cone	1
JLM714110	Bearing, Input Shaft Rear Cup	1
A11205X2728	Seal, Input Shaft	1
TL-0.5ML	Threadlocker	1
SEALANT	RTV Silicone	1

NDK4420-V100		
Part No.	Description	Qty.
32021	Bearing, Diff Right & Left Hand TRB	2
H715343	Bearing, Pinion Head Cone	1
H715311	Bearing, Pinion Head Cup	1
65237	Bearing, Pinion Tail Cone	1
65500	Bearing, Pinion Tail Cup	1
HM813843	Bearing, Input Shaft Front Cone	1
HM813810	Bearing, Input Shaft Front Cup	1
JLM714149	Bearing, Input Shaft Rear Cone	1
JLM714110	Bearing, Input Shaft Rear Cup	1
A11205X2728	Seal, Input Shaft	1

NDK4422		
Part No.	Description	Qty.
594A	Bearing, Diff Right & Left Hand Cone	2
592A	Bearing, Diff Right & Left Hand Cup	2
H715343	Bearing, Pinion Head Cone	1
H715311	Bearing, Pinion Head Cup	1
65237	Bearing, Pinion Tail Cone	1
65500	Bearing, Pinion Tail Cup	1
HM813843	Bearing, Input Shaft Front Cone	1
HM813810	Bearing, Input Shaft Front Cup	1
JLM714149	Bearing, Input Shaft Rear Cone	1
JLM714110	Bearing, Input Shaft Rear Cup	1
5X1034	O-Ring	2
A11205X2728-NTN	Seal, Input Shaft	1
TL-0.5ML	Threadlocker	1
SEALANT	RTV Silicone	1

NDK4422-V100		
Part No.	Description	Qty.
594A	Bearing, Diff Right & Left Hand Cone	2
592A	Bearing, Diff Right & Left Hand Cup	2
H715343	Bearing, Pinion Head Cone	1
H715311	Bearing, Pinion Head Cup	1
65237	Bearing, Pinion Tail Cone	1
65500	Bearing, Pinion Tail Cup	1
HM813843	Bearing, Input Shaft Front Cone	1
HM813810	Bearing, Input Shaft Front Cup	1
JLM714149	Bearing, Input Shaft Rear Cone	1
JLM714110	Bearing, Input Shaft Rear Cup	1
5X1034	O-Ring	2
A11205X2728-NTN	Seal, Input Shaft	1

NDK4423		
Part No.	Description	Qty.
594A	Bearing, Diff Right Hand Cone	1
592A	Bearing, Diff Right Hand Cup	1
52400	Bearing, Diff Left Hand Cone	1
52618	Bearing, Diff Left Hand Cup	1
H715343	Bearing, Pinion Head Cone	1
H715311	Bearing, Pinion Head Cup	1
65237	Bearing, Pinion Tail Cone	1
65500	Bearing, Pinion Tail Cup	1
HM813843	Bearing, Input Shaft Front Cone	1
HM813810	Bearing, Input Shaft Front Cup	1
JLM714149	Bearing, Input Shaft Rear Cone	1
JLM714110	Bearing, Input Shaft Rear Cup	1
5X1034	O-Ring	1
A11205X2728 - NTN	Seal, Input Shaft	1
TL-0.5ML	Threadlocker	1
SEALANT	RTV Silicone	1

NDK4423-V100		
Part No.	Description	Qty.
594A	Bearing, Diff Right Hand Cone	1
592A	Bearing, Diff Right Hand Cup	1
52400	Bearing, Diff Left Hand Cone	1
52618	Bearing, Diff Left Hand Cup	1
H715343	Bearing, Pinion Head Cone	1
H715311	Bearing, Pinion Head Cup	1
65237	Bearing, Pinion Tail Cone	1
65500	Bearing, Pinion Tail Cup	1
HM813843	Bearing, Input Shaft Front Cone	1
HM813810	Bearing, Input Shaft Front Cup	1
JLM714149	Bearing, Input Shaft Rear Cone	1
JLM714110	Bearing, Input Shaft Rear Cup	1
5X1034	O-Ring	1
A11205X2728 - NTN	Seal, Input Shaft	1

NDK4426		
Part No.	Description	Qty.
594A	Bearing, Diff Right & Left Hand Cone	2
592A	Bearing, Diff Right & Left Hand Cup	2
9278	Bearing, Pinion Head Cone	1
9220	Bearing, Pinion Head Cup	1
HM813843	Bearing, Pinion Tail Cone	1
HM813810	Bearing, Pinion Tail Cup	1
RU9008UM	Bearing, Pinion	1
A1205Q2591	Seal, Input Shaft	1
TL-0.5ML	Threadlocker	1
SEALANT	RTV Silicone	1

NDK4426-V100		
Part No.	Description	Qty.
594A	Bearing, Diff Right & Left Hand Cone	2
592A	Bearing, Diff Right & Left Hand Cup	2
9278	Bearing, Pinion Head Cone	1
9220	Bearing, Pinion Head Cup	1
HM813843	Bearing, Pinion Tail Cone	1
HM813810	Bearing, Pinion Tail Cup	1
RU9008UM	Bearing, Pinion	1
A1205Q2591	Seal, Input Shaft	1

NDK4428		
Part No.	Description	Qty.
594A	Bearing, Diff Right & Left Hand Cone	1
592A	Bearing, Diff Right & Left Hand Cup	1
52400	Bearing, Diff Left Hand Cone	1
52618	Bearing, Diff Left Hand Cup	1
9278	Bearing, Pinion Head Cone	1
9220	Bearing, Pinion Head Cup	1
HM813843	Bearing, Pinion Tail Cone	1
HM813810	Bearing, Pinion Tail Cup	1
RU9008UM	Bearing, Pinion	1
A1205Q2591	Seal, Input Shaft	1
TL-0.5ML	Threadlocker	1
SEALANT	RTV Silicone	1

NDK4428-V100		
Part No.	Description	Qty.
594A	Bearing, Diff Right & Left Hand Cone	1
592A	Bearing, Diff Right & Left Hand Cup	1
52400	Bearing, Diff Left Hand Cone	1
52618	Bearing, Diff Left Hand Cup	1
9278	Bearing, Pinion Head Cone	1
9220	Bearing, Pinion Head Cup	1
HM813843	Bearing, Pinion Tail Cone	1
HM813810	Bearing, Pinion Tail Cup	1
RU9008UM	Bearing, Pinion	1
A1205Q2591	Seal, Input Shaft	1

NDK4435		
Part No.	Description	Qty.
64450	Bearing, Diff Right Hand Cone	1
64700	Bearing, Diff Right Hand Cup	1
JHM720249	Bearing, Diff Right Left Cone	1
JHM720210	Bearing, Diff Right Left Cup	1
9278	Bearing, Pinion Head Cone	1
9220	Bearing, Pinion Head Cup	1
H715334	Bearing, Pinion Tail Cone	1
H715311	Bearing, Pinion Tail Cup	1
MUB7309UM	Bearing, Pinion Nose CRB	1
1228-S-1267	Seal, Pinion	1
TL-0.5ML	Threadlocker	1
SEALANT	RTV Silicone	1

NDK4435-V100		
Part No.	Description	Qty.
64450	Bearing, Diff Right Hand Cone	1
64700	Bearing, Diff Right Hand Cup	1
JHM720249	Bearing, Diff Right Left Cone	1
JHM720210	Bearing, Diff Right Left Cup	1
9278	Bearing, Pinion Head Cone	1
9220	Bearing, Pinion Head Cup	1
H715334	Bearing, Pinion Tail Cone	1
H715311	Bearing, Pinion Tail Cup	1
MUB7309UM	Bearing, Pinion Nose CRB	1
1228-S-1267	Seal, Pinion	1

NDK4436		
Part No.	Description	Qty.
64450	Bearing, Diff Right Hand Cone	1
64700	Bearing, Diff Right Hand Cup	1
JHM720249	Bearing, Diff Left Hand Cone	1
JHM720210	Bearing, Diff Left Hand Cup	1
9278	Bearing, Pinion Head Cone	1
9220	Bearing, Pinion Head Cup	1
H715334	Bearing, Pinion Tail Cone	1
H715311	Bearing, Pinion Tail Cup	1
MUC1309UM	Bearing, Pinion Nose CRB	1
A1205Q2591	Seal, Pinion	1
TL-0.5ML	Threadlocker	1
SEALANT	RTV Silicone	1

NDK4436-V100		
Part No.	Description	Qty.
64450	Bearing, Diff Right Hand Cone	1
64700	Bearing, Diff Right Hand Cup	1
JHM720249	Bearing, Diff Left Hand Cone	1
JHM720210	Bearing, Diff Left Hand Cup	1
9278	Bearing, Pinion Head Cone	1
9220	Bearing, Pinion Head Cup	1
H715334	Bearing, Pinion Tail Cone	1
H715311	Bearing, Pinion Tail Cup	1
MUC1309UM	Bearing, Pinion Nose CRB	1
A1205Q2591	Seal, Pinion	1

NDK4437		
Part No.	Description	Qty.
JM822049	Bearing, Diff Right Hand Cone	1
JM822010	Bearing, Diff Right Hand Cup	1
594AVW5	Bearing, Diff Left Hand Cone	1
595BP1	Bearing, Diff Left Hand Cup	1
9278	Bearing, Pinion Head Cone	1
9220	Bearing, Pinion Head Cup	1
H715334PW3	Bearing, Pinion Tail Cone	1
H715311PW2	Bearing, Pinion Tail Cup	1
MUC1309UM	Bearing, Pinion Nose CRB	1
A1-1205A2731	Seal, Pinion	1
TL-0.5ML	Threadlocker	1
SEALANT	RTV Silicone	1

NDK4437-V100		
Part No.	Description	Qty.
JM822049	Bearing, Diff Right Hand Cone	1
JM822010	Bearing, Diff Right Hand Cup	1
594AVW5	Bearing, Diff Left Hand Cone	1
595BP1	Bearing, Diff Left Hand Cup	1
9278	Bearing, Pinion Head Cone	1
9220	Bearing, Pinion Head Cup	1
H715334PW3	Bearing, Pinion Tail Cone	1
H715311PW2	Bearing, Pinion Tail Cup	1
MUC1309UM	Bearing, Pinion Nose CRB	1
A1-1205A2731	Seal, Pinion	1

NDK4438		
Part No.	Description	Qty.
JM822049	Bearing, Diff Right Hand Cone	1
JM822010	Bearing, Diff Right Hand Cup	1
594AVW5	Bearing, Diff Left Hand Cone	1
595BP1	Bearing, Diff Left Hand Cup	1
9278	Bearing, Pinion Head Cone	1
9220	Bearing, Pinion Head Cup	1
H715334	Bearing, Pinion Tail Cone	1
H715311	Bearing, Pinion Tail Cup	1
MUC1309UM	Bearing, Pinion Nose CRB	1
A1-1205A2731	Seal, Pinion	1
TL-0.5ML	Threadlocker	1
SEALANT	RTV Silicone	1

NDK4438-V100		
Part No.	Description	Qty.
JM822049	Bearing, Diff Right Hand Cone	1
JM822010	Bearing, Diff Right Hand Cup	1
594AVW5	Bearing, Diff Left Hand Cone	1
595BP1	Bearing, Diff Left Hand Cup	1
9278	Bearing, Pinion Head Cone	1
9220	Bearing, Pinion Head Cup	1
H715334	Bearing, Pinion Tail Cone	1
H715311	Bearing, Pinion Tail Cup	1
MUC1309UM	Bearing, Pinion Nose CRB	1
A1-1205A2731	Seal, Pinion	1

NDK4440		
Part No.	Description	Qty.
NP928171	Bearing, Diff Right Cone	1
NP718759	Bearing, Diff Right Cup	1
52387P	Bearing, Diff Left Cone	1
52618P	Bearing, Diff Left Cup	1
78250AC	Bearing, Pinion Head & Pinion Tail Cone	2
78551	Bearing, Pinion Head & Pinion Tail Cup	2
M7309GEX (Outer Ring)*	Bearing, Pinion Nose CRB-OR	1
MRB7309 (Outer Ring)*	Bearing, Pinion Nose CRB-IR	1
MR7309 (Inner Ring)*	Bearing, Pinion Nose CRB-IR	1
HM813844	Bearing, Input Shaft Cone	1
HM813810	Bearing, Input Shaft Cup	1
JM515649	Bearing, Rear Side Gear Cone	1
JM515610	Bearing, Rear Side Gear Cup	1
385A	Bearing, Output Shaft Cone	2
382A	Bearing, Output Shaft Cup	2
LM11949-90013	Bearing, Oil Pump Idler Gear TRB - Assembly	1
SLS-1666	Seal, Input Shaft	1
SLS-1784	Seal, Thrushaft	1
SNR-1854*	Snap Ring	1
TL-0.5ML	Threadlocker	1
SEALANT	RTV Silicone	1

NDK4440-V100		
Part No.	Description	Qty.
NP928171	Bearing, Diff Right Cone	1
NP718759	Bearing, Diff Right Cup	1
52387P	Bearing, Diff Left Cone	1
52618P	Bearing, Diff Left Cup	1
78250AC	Bearing, Pinion Head & Pinion Tail Cone	2
78551	Bearing, Pinion Head & Pinion Tail Cup	2
M7309GEX (Outer Ring)*	Bearing, Pinion Nose CRB-OR	1
MRB7309 (Outer Ring)*	Bearing, Pinion Nose CRB-IR	1
MR7309 (Inner Ring)*	Bearing, Pinion Nose CRB-IR	1
HM813844	Bearing, Input Shaft Cone	1
HM813810	Bearing, Input Shaft Cup	1
JM515649	Bearing, Rear Side Gear Cone	1
JM515610	Bearing, Rear Side Gear Cup	1
385A	Bearing, Output Shaft Cone	2
382A	Bearing, Output Shaft Cup	2
LM11949-90013	Bearing, Oil Pump Idler Gear TRB - Assembly	1
SLS-1666	Seal, Input Shaft	1
SLS-1784	Seal, Thrushaft	1
SNR-1854*	Snap Ring	1

\*SNR-1854 IS INSTALLED ONTO M7309GEX, DEPENDING UPON DIFFERENTIAL, USE EITHER MRB7309 OR MR7309 AND ASSEMBLE WITH M7309GEX.

\*SNR-1854 IS INSTALLED ONTO M7309GEX, DEPENDING UPON DIFFERENTIAL, USE EITHER MRB7309 OR MR7309 AND ASSEMBLE WITH M7309GEX.

NDK4441		
Part No.	Description	Qty.
NP928171	Bearing, Diff Right Hand Cone	1
NP718759	Bearing, Diff Right Hand Cup	1
52387P	Bearing, Diff Left Hand Cone	1
52618P	Bearing, Diff Left Hand Cup	1
78250AC	Bearing, Pinion Head & Tail Cone	2
78551	Bearing, Pinion Head & Tail Cup	2
MUB7309UM	Bearing, Pinion Nose CRB	1
HM813844	Bearing, Input Shaft Cone	1
HM813810	Bearing, Input Shaft Cup	1
JM515649	Bearing, Rear Side Gear Cone	1
JM515610	Bearing, Rear Side Gear Cup	1
385A	Bearing, Output Shaft Cone	2
382A	Bearing, Output Shaft Cup	2
LM11949-90013	Bearing, Oil Pump Idler Gear TRB – Assembly	1
SLS-1666	Seal, Input Shaft	1
SLS-1784	Seal, Thrushaft	1
SNR-1833	Snap Ring	1
TL-0.5ML	Threadlocker	1
SEALANT	RTV Silicone	1

NDK4441-V100		
Part No.	Description	Qty.
NP928171	Bearing, Diff Right Hand Cone	1
NP718759	Bearing, Diff Right Hand Cup	1
52387P	Bearing, Diff Left Hand Cone	1
52618P	Bearing, Diff Left Hand Cup	1
78250AC	Bearing, Pinion Head & Tail Cone	2
78551	Bearing, Pinion Head & Tail Cup	2
MUB7309UM	Bearing, Pinion Nose CRB	1
HM813844	Bearing, Input Shaft Cone	1
HM813810	Bearing, Input Shaft Cup	1
JM515649	Bearing, Rear Side Gear Cone	1
JM515610	Bearing, Rear Side Gear Cup	1
385A	Bearing, Output Shaft Cone	2
382A	Bearing, Output Shaft Cup	2
LM11949-90013	Bearing, Oil Pump Idler Gear TRB – Assembly	1
SLS-1666	Seal, Input Shaft	1
SLS-1784	Seal, Thrushaft	1
SNR-1833	Snap Ring	1

NDK4841		
Part No.	Description	Qty.
594A	Bearing, Diff Right & Left Hand Cone	2
592A	Bearing, Diff Right & Left Hand Cup	2
H715334	Bearing, Pinion Head Cone	1
H715311	Bearing, Pinion Head Cup	1
72212C	Bearing, Pinion Tail Cone	1
72487	Bearing, Pinion Tail Cup	1
JM511945	Bearing, Input Shaft Front Cone	1
3920	Bearing, Input Shaft Front Cup	1
JLM714149	Bearing, Input Shaft Rear Cone	1
JLM714110	Bearing, Input Shaft Rear Cup	1
K75X83X23	Bearing, Input Helical Gear NRB	2
AXK1116	Bearing, Input Helical Gear NRB	1
SLS-1666	Seal, Input Shaft	1
TL-0.5ML	Threadlocker	1
SEALANT	RTV Silicone	1

NDK4841-V100		
Part No.	Description	Qty.
594A	Bearing, Diff Right & Left Hand Cone	2
592A	Bearing, Diff Right & Left Hand Cup	2
H715334	Bearing, Pinion Head Cone	1
H715311	Bearing, Pinion Head Cup	1
72212C	Bearing, Pinion Tail Cone	1
72487	Bearing, Pinion Tail Cup	1
JM511945	Bearing, Input Shaft Front Cone	1
3920	Bearing, Input Shaft Front Cup	1
JLM714149	Bearing, Input Shaft Rear Cone	1
JLM714110	Bearing, Input Shaft Rear Cup	1
K75X83X23	Bearing, Input Helical Gear NRB	2
AXK1116	Bearing, Input Helical Gear NRB	1
SLS-1666	Seal, Input Shaft	1

NDK4842		
Part No.	Description	Qty.
594A	Bearing, Diff Right & Left Hand Cone	2
592A	Bearing, Diff Right & Left Hand Cup	2
H715334	Bearing, Pinion Head Cone	2
H715311	Bearing, Pinion Head Cup	2
72212C	Bearing, Pinion Tail Cone	1
72487	Bearing, Pinion Tail Cup	1
SLS-1711	Seal, Thrushaft	1
TL-0.5ML	Threadlocker	1
SEALANT	RTV Silicone	1

NDK4842-V100		
Part No.	Description	Qty.
594A	Bearing, Diff Right & Left Hand Cone	2
592A	Bearing, Diff Right & Left Hand Cup	2
H715334	Bearing, Pinion Head Cone	2
H715311	Bearing, Pinion Head Cup	2
72212C	Bearing, Pinion Tail Cone	1
72487	Bearing, Pinion Tail Cup	1
SLS-1711	Seal, Thrushaft	1

NDK4843		
Part No.	Description	Qty.
NP293601	Bearing, Diff Right & Left Hand Cone	2
NP934397	Bearing, Diff Right & Left Hand Cup	2
55206C	Bearing, Pinion Tail Cone	1
55437	Bearing, Pinion Tail Cup	1
72212C	Bearing, Pinion Tail Cone	1
72487	Bearing, Pinion Tail Cup	1
RU1570UM	Bearing, Pinion Nose CRB	1
SLS-1711	Seal, Thrushaft	1
TL-0.5ML	Threadlocker	1
SEALANT	RTV Silicone	1

NDK4843-V100		
Part No.	Description	Qty.
NP293601	Bearing, Diff Right & Left Hand Cone	2
NP934397	Bearing, Diff Right & Left Hand Cup	2
55206C	Bearing, Pinion Tail Cone	1
55437	Bearing, Pinion Tail Cup	1
72212C	Bearing, Pinion Tail Cone	1
72487	Bearing, Pinion Tail Cup	1
RU1570UM	Bearing, Pinion Nose CRB	1
SLS-1711	Seal, Thrushaft	1

NDK4844		
Part No.	Description	Qty.
NP970652	Bearing, Diff Right Hand Cone	1
NP563664	Bearing, Diff Right Hand Cup	1
NP293601	Bearing, Diff Left Hand Cone	1
NP934397	Bearing, Diff Left Hand Cup	1
55206C	Bearing, Pinion Tail Cone	1
55437	Bearing, Pinion Tail Cup	1
72212C	Bearing, Pinion Head Cone	1
72487	Bearing, Pinion Head Cup	1
RU1570UM	Bearing, Pinion Nose CRB	1
SLS-1711	Seal, Thrushaft	1
TL-0.5ML	Threadlocker	1
SEALANT	RTV Silicone	1

NDK4844-V100		
Part No.	Description	Qty.
NP970652	Bearing, Diff Right Hand Cone	1
NP563664	Bearing, Diff Right Hand Cup	1
NP293601	Bearing, Diff Left Hand Cone	1
NP934397	Bearing, Diff Left Hand Cup	1
55206C	Bearing, Pinion Tail Cone	1
55437	Bearing, Pinion Tail Cup	1
72212C	Bearing, Pinion Head Cone	1
72487	Bearing, Pinion Head Cup	1
RU1570UM	Bearing, Pinion Nose CRB	1
SLS-1711	Seal, Thrushaft	1

BEARINGS		
Part No.	Qty.	Kit
382A	2	NDK204F
	2	NDK4125
	2	NDK4135
	2	NDK4140
	2	NDK4440
	2	NDK4441
385A	2	NDK4145
	2	NDK204F
	2	NDK4125
	2	NDK4135
	2	NDK4140
	2	NDK4145
392	2	NDK4440
392	2	NDK4441
394A	2	NDK204F
394A	2	NDK2111
395	2	NDK2111
492A	1	NDK206
	1	NDK206A
	1	NDK507
	1	NDK508
493	1	NDK1
	1	NDK1A
	2	NDK9F
	2	NDK9R
	2	NDK9RB
	2	NDK9RC
	1	NDK23
	1	NDK23D
	1	NDK24
	1	NDK64F
	1	NDK64FC
	1	NDK64FD
	1	NDK64FE
	1	NDK196
	1	NDK207
	1	NDK222F
	1	NDK222R
	2	NDK223F
	2	NDK223R
	1	NDK403
	1	NDK404F
	1	NDK404FA
	1	NDK404R
	1	NDK406
	1	NDK410
	1	NDK412
	1	NDK419
	1	NDK422
	1	NDK424
	1	NDK427
	1	NDK427A
	1	NDK429
	1	NDK445
	2	NDK600
1	NDK900F	
1	NDK900FA	
1	NDK4155	
1	NDK4155A	
1	NDK4180	
495	2	NDK223F

BEARINGS		
Part No.	Qty.	Kit
495	2	NDK223R
	2	NDK600
495A	1	NDK23
	1	NDK23D
495S	1	NDK507
	1	NDK508
496	2	NDK9F
	2	NDK9R
	2	NDK9RB
	1	NDK9RC
	1	NDK900F
	1	NDK900FA
	1	NDK4155
	1	NDK4155A
	1	NDK1
	1	NDK1A
497	1	NDK9RC
	1	NDK64F
	1	NDK64FC
	1	NDK64FD
	1	NDK64FE
	1	NDK196
	1	NDK206
	1	NDK206A
	1	NDK207
	1	NDK222F
	1	NDK222R
	1	NDK403
	1	NDK404F
	1	NDK404FA
	1	NDK404R
	1	NDK406
	1	NDK410
	1	NDK412
	1	NDK419
	1	NDK422
	1	NDK424
	1	NDK429
	1	NDK445
	1	NDK900F
1	NDK900FA	
1	NDK4180	
498	1	NDK24
552A	1	NDK205
	1	NDK205A
	1	NDK404F
	1	NDK404FA
	1	NDK405F
555S	1	NDK405FA
	1	NDK503
	1	NDK404F
555S	1	NDK404FA
	1	NDK405F
557S	1	NDK405FA
	1	NDK205
559	1	NDK205A
	1	NDK503
563	1	NDK1A
	1	NDK23B
	1	NDK64FC
	1	NDK64FD
	1	NDK196

BEARINGS		
Part No.	Qty.	Kit
563	1	NDK222F
	1	NDK222R
	1	NDK404F
	1	NDK404FA
	1	NDK404R
	1	NDK405FA
	1	NDK405R
	1	NDK412
	1	NDK422
	1	NDK445
567	1	NDK1A
	1	NDK23B
	1	NDK64FC
	1	NDK64FD
	1	NDK196
	1	NDK222F
	1	NDK222R
	1	NDK404F
	1	NDK404FA
	1	NDK404R
	1	NDK405FA
	1	NDK405R
	1	NDK412
	1	NDK422
572	1	NDK445
	1	NDK206
	1	NDK206A
576	2	NDK4180
	2	NDK4180
592A	1	NDK50
	1	NDK50A
	2	NDK117
	2	NDK117A
	1	NDK406
	1	NDK410
	1	NDK500
	1	NDK4125
	1	NDK4130
	1	NDK4135
	1	NDK4140
	1	NDK4145
	1	NDK4150
	1	NDK4155
	1	NDK4155A
	2	NDK4422
	1	NDK4423
2	NDK4426	
1	NDK4428	
2	NDK4841	
2	NDK4842	
594A	2	NDK4422
	1	NDK4423
	2	NDK4426
	1	NDK4428
594AVW5	2	NDK4841
	2	NDK4842
	2	NDK4842
594AVW5	1	NDK4437
	1	NDK4438
595BP1	1	NDK4437
	1	NDK4438



BEARINGS		
Part No.	Qty.	Kit
596	1	NDK500
598	1	NDK50
	1	NDK50A
	1	NDK406
	1	NDK410
	1	NDK4125
	1	NDK4130
	1	NDK4135
	1	NDK4140
	1	NDK4145
	1	NDK4150
	1	NDK4155
1	NDK4155A	
598A	2	NDK117
	2	NDK117A
612	1	NDK205
	1	NDK205A
	1	NDK206
	1	NDK206A
	1	NDK503
	1	NDK507
	1	NDK508
621	1	NDK205
	1	NDK205A
	1	NDK206
	1	NDK206A
	1	NDK503
	1	NDK507
	1	NDK508
632	2	NDK204F
641	2	NDK204F
653	1	NDK18D
	1	NDK18E
	1	NDK208
	1	NDK208A
	1	NDK212F
	1	NDK415
	1	NDK418
	1	NDK431
	1	NDK433
	1	NDK449
661	1	NDK212F
665	1	NDK18D
	1	NDK18E
	1	NDK208
	1	NDK208A
	1	NDK415
	1	NDK418
	1	NDK431
	1	NDK433
672	2	NDK2108
687	2	NDK2108
740	1	NDK212F
742	1	NDK212F
752B	1	NDK212F
	1	NDK212R
753A	1	NDK212F
	1	NDK212R
766	2	NDK212F
	2	NDK212R
833W	1	NDK506

BEARINGS		
Part No.	Qty.	Kit
835	1	NDK506
1211	1	NDK507
1213L	1	NDK206
	1	NDK206A
1311L	1	NDK507
	1	NDK64FC
1311L0	1	NDK64F
3204	1	NDK4125
3720	1	NDK419
	1	NDK422
	1	NDK424
3780	1	NDK419
	1	NDK424
3820	2	NDK200F
	2	NDK201F
	1	NDK418
	1	NDK420
	1	NDK421
3870	1	NDK422
3872	1	NDK418
	1	NDK420
	1	NDK421
3877	2	NDK200F
	2	NDK201F
3920	2	NDK23B
	2	NDK191R
	2	NDK414
	2	NDK418
	1	NDK419
	1	NDK420
	1	NDK421
	1	NDK426
	1	NDK434
	1	NDK449
	1	NDK650F
	1	NDK4395
	1	NDK4396
	1	NDK4405
1	NDK4406	
1	NDK4841	
3925	2	NDK191F
	2	NDK202
3979	1	NDK196
	1	NDK207
	1	NDK222F
	1	NDK418
	1	NDK419
	1	NDK420
	2	NDK421
	1	NDK422
	1	NDK424
	1	NDK426
3984	2	NDK191F
	2	NDK191R
	2	NDK202
	2	NDK414
	2	NDK434
	2	NDK449
3994	1	NDK23B
	1	NDK218
	2	NDK4310
	2	NDK4315

BEARINGS		
Part No.	Qty.	Kit
4381	1	NDK219R
5211W	1	NDK4180
5735	1	NDK205
	1	NDK205A
	1	NDK503
5760	1	NDK205
	1	NDK205A
	1	NDK503
6022NR	1	NDK191F
6210	1	NDK172F
	1	NDK172FA
	1	NDK191F
	1	NDK200F
	1	NDK200FA
	1	NDK201F
	1	NDK201FA
	1	NDK4100
	1	NDK4180
	2	NDK9F
6211	1	NDK900F
	1	NDK900FA
6213ZNR	1	NDK191F
6310	1	NDK191F
6313	1	NDK172F
	1	NDK172FA
	1	NDK208A
6320	1	NDK209
	2	NDK117
6379	2	NDK117A
	2	NDK117
6420	1	NDK117A
	1	NDK17A
6460	1	NDK212R
	1	NDK501
6466	1	NDK506
	1	NDK506
6535W	1	NDK212R
	1	NDK212F
	1	NDK506
6576	1	NDK506
	1	NDK212F
6580	1	NDK212R
	1	NDK212R
6926LU	1	NDK200F
	1	NDK200FA
	1	NDK201F
7213BG	2	NDK201FA
72188C	1	NDK212F
	1	NDK9R
	1	NDK9RB
9121	1	NDK9RC
9185	1	NDK416
	1	NDK416
	1	NDK4415
	1	NDK4426
	1	NDK4428
	1	NDK4435
9220	1	NDK4436
	1	NDK4437
	1	NDK4438
9278	1	NDK4415
	1	NDK4426

BEARINGS		
Part No.	Qty.	Kit
9278	1	NDK4428
	1	NDK4435
	1	NDK4436
	1	NDK4437
	1	NDK4438
25821	2	NDK191F
25877	2	NDK191F
28620	1	NDK405FA
28921	1	NDK200F
	1	NDK200FA
	1	NDK201F
	1	NDK201FA
28985	1	NDK200F
	1	NDK200FA
	1	NDK201F
	1	NDK201FA
29620	1	NDK196
	1	NDK207
	1	NDK222F
	1	NDK404FA
	1	NDK405F
	1	NDK422
	1	NDK424
	1	NDK427A
	1	NDK428A
	1	NDK4155
	1	NDK4155A
29630	2	NDK9F
	1	NDK404F
	1	NDK427
	1	NDK428
	2	NDK900F
29675	2	NDK900FA
	2	NDK9F
	1	NDK196
	1	NDK207
	1	NDK222F
	1	NDK404F
	1	NDK405F
	1	NDK422
	1	NDK424
	1	NDK427
	1	NDK428
29685	2	NDK900F
	2	NDK900FA
	1	NDK4155
29688	1	NDK4155A
	1	NDK427A
	1	NDK428A
31520	1	NDK404FA
	1	NDK405FA
	1	NDK900FA
31597	2	NDK9F
	2	NDK900F
	2	NDK900FA
32014X	1	NDK651
32017X	1	NDK650F
	1	NDK650R
32020X	1	NDK651
32021	2	NDK4415
	2	NDK4420

BEARINGS		
Part No.	Qty.	Kit
32022X	1	NDK650F
	1	NDK650R
32024X	1	NDK401
	1	NDK24
	1	NDK208
	1	NDK208A
	1	NDK209
	1	NDK210
	1	NDK211F
	1	NDK211FA
	1	NDK426
	1	NDK431
	1	NDK432
	1	NDK433
	1	NDK449
	1	NDK4325
	32275	1
1		NDK208
1		NDK208A
1		NDK209
1		NDK210
1		NDK211F
1		NDK211FA
1		NDK426
1		NDK431
1		NDK432
1		NDK433
1		NDK449
1		NDK4325
1		NDK24
33472		1
	1	NDK208A
	1	NDK209
	1	NDK210
	1	NDK211F
	1	NDK211FA
	1	NDK426
	1	NDK431
	1	NDK432
	1	NDK433
	1	NDK449
	1	NDK4325
	1	NDK64F
	1	NDK64FC
	34274	1
1		NDK64FE
1		NDK64FE
34306	1	NDK218
34429A	1	NDK64F
34478	1	NDK218
34492A	1	NDK64FC
	1	NDK64FD
	1	NDK64FE
42346	1	NDK72
	1	NDK72A
	1	NDK72B
	1	NDK209
	1	NDK210
	1	NDK421
	1	NDK426
	1	NDK426
42350	2	NDK204F
	1	NDK4180
42362	1	NDK405F
	1	NDK405FA
	1	NDK405R
	1	NDK428
	1	NDK428A
42381	1	NDK430
	1	NDK430
	1	NDK18D
	1	NDK18E
	1	NDK23
	1	NDK23D
	1	NDK208
42381	1	NDK208A
	1	NDK211F
	1	NDK650F
	1	NDK650R
	1	NDK401

BEARINGS		
Part No.	Qty.	Kit
42381	1	NDK211FA
	1	NDK216
	1	NDK219R
	1	NDK220F
	1	NDK220FA
	1	NDK413
	1	NDK413
	1	NDK415
	1	NDK418
	1	NDK420
	1	NDK431
	1	NDK432
	1	NDK433
	1	NDK449
	1	NDK449
	1	NDK18D
	1	NDK18E
	1	NDK23
	1	NDK23D
	1	NDK72
	1	NDK72A
42584	1	NDK72B
	2	NDK204F
	1	NDK208
	1	NDK208A
	1	NDK209
	1	NDK210
	1	NDK211F
	1	NDK211FA
	1	NDK216
	1	NDK219R
	1	NDK220F
	1	NDK220FA
	1	NDK405F
	1	NDK405FA
	1	NDK405R
	1	NDK413
	1	NDK415
	1	NDK418
	1	NDK420
	1	NDK421
	1	NDK426
1	NDK428	
1	NDK428A	
1	NDK430	
1	NDK431	
1	NDK432	
1	NDK433	
1	NDK449	
1	NDK4180	
44143	1	NDK2111
44348	1	NDK2111
47420	1	NDK4325
47490	1	NDK4325
47623A	1	NDK205
	1	NDK206
	1	NDK500
	1	NDK501
	1	NDK503
	1	NDK507
47687	1	NDK508
	1	NDK205

BEARINGS		
Part No.	Qty.	Kit
47687	1	NDK206
	1	NDK500
	1	NDK501
	1	NDK503
	1	NDK507
	1	NDK508
47820	2	NDK172F
	2	NDK172FA
	2	NDK172FB
	2	NDK172R
	2	NDK192R
	2	NDK192RB
	2	NDK200F
	2	NDK200FA
	2	NDK4095
	2	NDK4100
47890	2	NDK4105
	2	NDK200FA
	2	NDK200F
	2	NDK192RB
	2	NDK192R
	2	NDK172FB
	2	NDK172FA
	2	NDK172R
	2	NDK4095
	2	NDK4100
52387	1	NDK50
	1	NDK50A
	1	NDK4125
	1	NDK4130
	1	NDK4135
	1	NDK4140
	1	NDK4145
	1	NDK4150
	1	NDK4155
	1	NDK4155A
52387P	1	NDK4440
	1	NDK4441
52400	1	NDK4423
	1	NDK4428
52618	1	NDK50
	1	NDK50A
	1	NDK4125
	1	NDK4130
	1	NDK4135
	1	NDK4140
	1	NDK4145
	1	NDK4150
	1	NDK4155
	1	NDK4155A
52618P	1	NDK4440
	1	NDK4441
55175C	2	NDK23D
	2	NDK191F
	2	NDK191R
	1	NDK414
55200C	2	NDK1
	1	NDK1A

BEARINGS		
Part No.	Qty.	Kit
55200C	1	NDK214
	1	NDK216
	1	NDK218
	1	NDK222R
	1	NDK403
	1	NDK404R
	1	NDK405R
	1	NDK406
	1	NDK412
	1	NDK429
	1	NDK430
	1	NDK434
	1	NDK445
	1	NDK449
	1	NDK4330
	55206C	1
1		NDK4375
1		NDK4390
1		NDK4400
1		NDK4843
1		NDK4844
55212C	1	NDK404F
	1	NDK404FA
	1	NDK427
	1	NDK427A
	1	NDK428
	1	NDK428A
	1	NDK405F
	1	NDK405FA
	2	NDK1
	1	NDK1A
55437	2	NDK23D
	2	NDK191F
	2	NDK191R
	1	NDK214
	1	NDK216
	1	NDK217R
	1	NDK218
	1	NDK222R
	1	NDK403
	1	NDK404F
	1	NDK404FA
	1	NDK404R
	1	NDK405F
	1	NDK405FA
	1	NDK405R
	1	NDK406
	1	NDK412
	1	NDK414
	1	NDK427
	1	NDK427A
1	NDK428	
1	NDK428A	
1	NDK429	
1	NDK430	
1	NDK434	
1	NDK445	
1	NDK449	
1	NDK4330	
1	NDK4375	
1	NDK4390	
1	NDK4400	

BEARINGS		
Part No.	Qty.	Kit
55437	1	NDK4843
	1	NDK4844
56425	1	NDK1
	1	NDK64F
	1	NDK64FE
	2	NDK201F
	2	NDK201FA
	2	NDK201R
	1	NDK207
	1	NDK402
	1	NDK403
	2	NDK416
	1	NDK419
	1	NDK424
56650	1	NDK1
	1	NDK64F
	1	NDK64FE
	2	NDK201F
	2	NDK201FA
	2	NDK201R
	1	NDK207
	1	NDK402
	1	NDK403
	2	NDK416
1	NDK419	
1	NDK424	
64450	1	NDK4435
	1	NDK4436
64700	1	NDK4435
	1	NDK4436
65212	1	NDK117
	1	NDK117A
65225	1	NDK212R
	1	NDK506
65237	1	NDK172F
	1	NDK172FA
	1	NDK172FB
	1	NDK194R
	1	NDK194RA
	2	NDK204R
	1	NDK4095
	1	NDK4100
	1	NDK4420
	1	NDK4422
1	NDK4423	
65500	1	NDK117
	1	NDK117A
	1	NDK172F
	1	NDK172FA
	1	NDK172FB
	1	NDK194R
	1	NDK194RA
	2	NDK204R
	1	NDK212R
	1	NDK506
	1	NDK4095
	1	NDK4100
1	NDK4420	
1	NDK4422	
1	NDK4423	
66212	1	NDK600
66225	2	NDK4180

BEARINGS		
Part No.	Qty.	Kit
66462	1	NDK600
	2	NDK4180
68450	1	NDK72
	1	NDK72A
	1	NDK211FA
	1	NDK220F
68462	1	NDK72B
	1	NDK209
	1	NDK210
	1	NDK211F
	1	NDK219R*
	1	NDK220FA
	1	NDK413
	1	NDK420
	1	NDK421
	1	NDK426
	1	NDK432
	1	NDK72
68712	1	NDK72A
	1	NDK72B
	1	NDK209
	1	NDK210
	1	NDK211F
	1	NDK211FA
	1	NDK219R
	1	NDK220F
	1	NDK220FA
	1	NDK413
	1	NDK420
	1	NDK421
	1	NDK426
	1	NDK432
	1	NDK421
	72200C	2
1		NDK9R
1		NDK9RB
1		NDK9RC
2		NDK64F
2		NDK64FC
2		NDK64FD
2		NDK64FE
1		NDK222R
1		NDK403
1		NDK412
1		NDK445
2		NDK900F
2		NDK900FA
72201C	1	NDK194R
72212C	1	NDK18D
	1	NDK18E
	2	NDK72
	1	NDK72A
	1	NDK72B
	2	NDK194F
	2	NDK194RB
	2	NDK208
	2	NDK208A
	2	NDK209
	2	NDK210
	2	NDK211F
	2	NDK211FA
	1	NDK217F
1	NDK217R	

BEARINGS		
Part No.	Qty.	Kit
72212C	1	NDK219R
	2	NDK220F
	2	NDK220FA
	1	NDK405R
	1	NDK413
	2	NDK415
	2	NDK418
	2	NDK420
	2	NDK421
	2	NDK426
	1	NDK429
	1	NDK430
	2	NDK431
	1	NDK432
	2	NDK433
	1	NDK434
	2	NDK449
	1	NDK4390
	1	NDK4395
	1	NDK4396
	1	NDK4400
	1	NDK4405
	1	NDK4406
	1	NDK4841
	1	NDK4842
	1	NDK4843
	1	NDK4844
	1	NDK196
	1	NDK207
	1	NDK222F
	1	NDK404F
	1	NDK404FA
	1	NDK419
	1	NDK422
	1	NDK424
	1	NDK427
	1	NDK427A
	1	NDK428
	1	NDK428A
	1	NDK405F
	1	NDK405FA
	2	NDK192R
	2	NDK192RB
	1	NDK194RA
	2	NDK200F
	2	NDK200FA
	1	NDK214
2	NDK223F	
2	NDK223R	
1	NDK414	
1	NDK600	
1	NDK9F	
1	NDK9R	
1	NDK9RB	
1	NDK9RC	
2	NDK18D	
2	NDK18E	
1	NDK64F	
1	NDK64FC	
1	NDK64FD	
1	NDK64FE	
1	NDK72	
72218C	1	NDK196
	1	NDK207
	1	NDK222F
	1	NDK404F
	1	NDK404FA
	1	NDK419
	1	NDK422
	1	NDK424
	1	NDK427
	1	NDK427A
	1	NDK428
	1	NDK428A
	1	NDK405F
	1	NDK405FA
72225C	2	NDK192R
	2	NDK192RB
	1	NDK194RA
	2	NDK200F
	2	NDK200FA
	1	NDK214
	2	NDK223F
	2	NDK223R
	1	NDK414
	1	NDK600
	1	NDK9F
	1	NDK9R
	1	NDK9RB
	1	NDK9RC
72487	2	NDK18D
	2	NDK18E
	1	NDK64F
	1	NDK64FC
	1	NDK64FD
	1	NDK64FE
	1	NDK72
	1	NDK72A
	1	NDK72B
	1	NDK194R
	1	NDK194RB
	1	NDK208
	1	NDK208A
	1	NDK209

BEARINGS		
Part No.	Qty.	Kit
72487	1	NDK72A
	1	NDK72B
	2	NDK192R
	2	NDK192RB
	2	NDK194F
	2	NDK194R
	2	NDK194RA
	2	NDK194RB
	2	NDK196
	2	NDK200F
	2	NDK200FA
	2	NDK207
	2	NDK208
	2	NDK208A
	2	NDK209
	2	NDK210
	2	NDK211F
	2	NDK211FA
	2	NDK214
	2	NDK217F
	2	NDK217R
	2	NDK219R
	2	NDK219R
	2	NDK220F
	2	NDK220FA
	2	NDK222F
	2	NDK222R
	2	NDK223F
	2	NDK223R
	2	NDK403
	2	NDK404F
	2	NDK404FA
	2	NDK404R
	2	NDK405F
	1	NDK405FA
	1	NDK405R
	1	NDK412
	1	NDK413
	1	NDK414
	2	NDK415
	2	NDK418
	1	NDK419
	1	NDK420
	1	NDK421
	1	NDK422
	1	NDK424
	1	NDK426
1	NDK427	
1	NDK427A	
1	NDK428	
1	NDK428A	
1	NDK429	
1	NDK430	
1	NDK431	
1	NDK432	
1	NDK433	
1	NDK434	
1	NDK445	
1	NDK449	
1	NDK600	
1	NDK900F	
1	NDK900FA	

BEARINGS		
Part No.	Qty.	Kit
72487	1	NDK4390
	1	NDK4395
	1	NDK4396
	1	NDK4400
	1	NDK4405
	1	NDK4406
	1	NDK4841
	1	NDK4842
	1	NDK4843
77375	2	NDK506
77676BW	1	NDK506
77676W	1	NDK506
78215C	1	NDK18D
	1	NDK18E
	1	NDK72A
	1	NDK72B
	1	NDK219R
	1	NDK406
	1	NDK413
78225C	1	NDK4375
78250AC	2	NDK4125
	2	NDK4135
	2	NDK4140
	2	NDK4145
	2	NDK4155
	2	NDK4155A
	2	NDK4440
78551	1	NDK18D
	1	NDK18E
	1	NDK72A
	1	NDK72B
	1	NDK219R
	1	NDK406
	1	NDK413
	1	NDK449
	2	NDK4125
	2	NDK4135
	2	NDK4140
	2	NDK4145
	2	NDK4155
	2	NDK4155A
1	NDK4375	
2	NDK4440	
2	NDK4441	
772212C	1	NDK404R
A-1400	1	NDK223F
AXK1116	1	NDK4841
	1	NDK650F
B-3624	1	NDK223F
BL211	1	NDK500
BL212	1	NDK212F
BL213N	1	NDK500
F-805096	1	NDK650F
	1	NDK650R
F-805097	1	NDK650F
	1	NDK650R
H414210	1	NDK212F
	1	NDK212R
H414235	1	NDK212F

BEARINGS		
Part No.	Qty.	Kit
H414235	1	NDK212R
H715310	1	NDK117
	1	NDK117A
	2	NDK50
	1	NDK50A
	1	NDK172F
	1	NDK172FA
	1	NDK172FB
	1	NDK172R
	1	NDK201F
	1	NDK201FA
	1	NDK201R
	1	NDK204R
	1	NDK217F
	1	NDK416
H715311	3	NDK500
	3	NDK501
	1	NDK2108
	1	NDK4095
	1	NDK4100
	2	NDK4105
	2	NDK4130
	2	NDK4150
	1	NDK4395
	1	NDK4396
	1	NDK4405
	1	NDK4406
	1	NDK4420
	1	NDK4422
	1	NDK4423
	1	NDK4435
	1	NDK4436
	1	NDK4438
	1	NDK4841
	2	NDK4842
	H715311PW2	1
H715313W	1	NDK205
	1	NDK205A
	1	NDK206
	1	NDK206A
	1	NDK503
	1	NDK50
H715334	2	NDK172R
	1	NDK217F
	1	NDK500
	2	NDK501
	1	NDK4105
	1	NDK4130
	1	NDK4150
	1	NDK4395
	1	NDK4396
	1	NDK4405
	1	NDK4406
	1	NDK4435
	1	NDK4436
	1	NDK4438
	1	NDK4841
	2	NDK4842
	H715334PW3	1
H715340	1	NDK117
	1	NDK117A
H715341	1	NDK2108

BEARINGS			
Part No.	Qty.	Kit	
H715343	1	NDK50	
	1	NDK50A	
	1	NDK172F	
	1	NDK172FA	
	1	NDK172FB	
	1	NDK172R	
	1	NDK201F	
	1	NDK201FA	
	1	NDK201R	
	1	NDK416	
	1	NDK4095	
	1	NDK4100	
	1	NDK4105	
	1	NDK4130	
	1	NDK4150	
	1	NDK4420	
	1	NDK4422	
	1	NDK4423	
	H715345	1	NDK204R
		1	NDK205
1		NDK205A	
1		NDK206	
1		NDK206A	
1		NDK500	
1		NDK501	
H715348	1	NDK500	
H914811	1	NDK401	
	1	NDK402	
H914841	1	NDK401	
	1	NDK402	
	1	NDK410	
HM88610	1	NDK426	
HM88649	1	NDK426	
HM516410	2	NDK204F	
	2	NDK204R	
HM516414A	1	NDK205A	
	1	NDK206A	
HM516414B	1	NDK205	
	1	NDK205A	
	1	NDK206	
	1	NDK206A	
	1	NDK500	
	1	NDK501	
	1	NDK503	
	1	NDK507	
HM516448	1	NDK508	
	1	NDK205	
	1	NDK205A	
	1	NDK206	
	1	NDK206A	
	1	NDK500	
	1	NDK501	
	1	NDK503	
	1	NDK507	
	1	NDK508	
HM516449C	2	NDK204F	
	2	NDK204R	
HM518411	1	NDK507	
	1	NDK508	
HM518411W	1	NDK507	

BEARINGS		
Part No.	Qty.	Kit
HM518411W	1	NDK508
HM518437	2	NDK507
	2	NDK508
HM713841	1	NDK402
HM803110	2	NDK4315
HM803149	2	NDK4315
HM804810	1	NDK218
	1	NDK4330
HM804846	1	NDK218
	1	NDK4330
HM807010	1	NDK196
	1	NDK204R
	1	NDK207
	1	NDK222F
	1	NDK223F
	1	NDK419
	1	NDK422
	1	NDK424
HM807044	1	NDK4325
HM807046	1	NDK204R
HM807049	1	NDK196
	1	NDK207
	1	NDK222F
	1	NDK223F
	1	NDK419
	1	NDK422
	1	NDK424
HM813810	1	NDK50A
	1	NDK201F
	1	NDK201FA
	1	NDK201R
	1	NDK401
	1	NDK402
	1	NDK410
	1	NDK436
	1	NDK437
	1	NDK442
	1	NDK2108
	1	NDK4125
	1	NDK4135
	1	NDK4140
	1	NDK4145
	1	NDK4415
	1	NDK4420
	1	NDK4422
	1	NDK4423
	1	NDK4426
1	NDK4428	
1	NDK4440	
1	NDK4441	
1	NDK401	
HM813841	1	NDK410
1	NDK4125	
HM813843	1	NDK50A
	1	NDK4415
	1	NDK4420
	1	NDK4422
	1	NDK4423
	1	NDK4426
1	NDK4428	
HM813844	1	NDK201F

BEARINGS		
Part No.	Qty.	Kit
HM813844	1	NDK201FA
	1	NDK201R
	1	NDK436
	1	NDK437
	1	NDK442
	1	NDK2108
	1	NDK4135
	1	NDK4140
	1	NDK4145
	1	NDK4440
	1	NDK4441
HM903210	2	NDK23
	2	NDK23B
	2	NDK24
	2	NDK202
HM903216	2	NDK4310
HM903249	2	NDK23
	2	NDK23B
	2	NDK24
HM903249A	2	NDK202
	2	NDK4310
JH211710	1	NDK172FB
	1	NDK220F
	1	NDK418
	1	NDK420
	1	NDK421
	1	NDK220FA
	1	NDK4095
	1	NDK4100
	1	NDK172FB
	1	NDK220F
JH211749	1	NDK220FA
	1	NDK418
	1	NDK420
	1	NDK421
	1	NDK4095
	1	NDK4100
JHM720210	1	NDK4435
JHM720249	1	NDK4436
1	NDK4435	
1	NDK4436	
JLM104910	2	NDK172FB
	1	NDK217F
	2	NDK427
	2	NDK427A
	2	NDK428
	2	NDK428A
	2	NDK4095
	2	NDK4395
	2	NDK4396
	2	NDK4405
	2	NDK4406
	1	NDK194F
	2	NDK200F
	2	NDK200FA
JLM710910	2	NDK201F
	2	NDK201FA
	1	NDK217F
	1	NDK223F
	1	NDK4395
	1	NDK4396
	1	NDK4405
	1	NDK194F
	2	NDK200F
	2	NDK200FA

BEARINGS		
Part No.	Qty.	Kit
JLM710910	1	NDK4406
JLM710949	1	NDK223F
	1	NDK4395
	1	NDK4396
	1	NDK4405
	1	NDK4406
JLM710949C	1	NDK194F
	2	NDK200F
	2	NDK200FA
	2	NDK201F
	2	NDK201FA
	1	NDK217F
JLM714110	1	NDK172FB
	1	NDK216
	1	NDK650F
	1	NDK4095
	1	NDK4100
	2	NDK4330
	1	NDK4420
	1	NDK4422
	1	NDK4423
	1	NDK4841
	1	NDK172FB
JLM714149	1	NDK216
	1	NDK650F
	1	NDK4095
	1	NDK4100
	2	NDK4330
	1	NDK4420
	1	NDK4422
	1	NDK4423
	1	NDK4841
	1	NDK217R
JM16610	1	NDK4400
JM207010	1	NDK64FD
	1	NDK64FE
JM207049	1	NDK64FD
	1	NDK64FE
JM511910	1	NDK194F
	1	NDK196
	1	NDK207
	1	NDK208
	1	NDK210
	1	NDK211F
	1	NDK211FA
	1	NDK217F
	1	NDK218
	1	NDK222F
	1	NDK418
	1	NDK419
	1	NDK420
	1	NDK421
	1	NDK422
	1	NDK424
	1	NDK426
1	NDK431	
1	NDK433	
1	NDK449	
2	NDK4310	
2	NDK4315	
1	NDK4405	
JM511945	1	NDK4396

BEARINGS		
Part No.	Qty.	Kit
JM511945	1	NDK4406
	1	NDK4841
	2	NDK650F
JM511946	1	NDK194F
	1	NDK208
	1	NDK210
	1	NDK211F
	1	NDK211FA
	1	NDK217F
	1	NDK220F
	1	NDK220FA
	1	NDK418
	1	NDK420
	1	NDK421
	1	NDK426
	1	NDK431
	1	NDK432
	1	NDK433
	1	NDK449
	JM515610	1
1		NDK4405
1		NDK4125
1		NDK4135
1		NDK4140
1		NDK4145
1		NDK4440
JM515649	1	NDK4441
	1	NDK4125
	1	NDK4135
	1	NDK4140
JM716610	1	NDK4145
	1	NDK4440
	1	NDK4441
	2	NDK194F
	2	NDK194R
	2	NDK194RA
	2	NDK194RB
	1	NDK214
	2	NDK217F
	1	NDK4375
	1	NDK4390
	2	NDK4395
	2	NDK4396
JM716649	1	NDK4405
	1	NDK4406
	2	NDK194F
	2	NDK194R
	2	NDK194RA
	2	NDK194RB
	1	NDK214
	2	NDK217F
	1	NDK217R
	1	NDK4375
	1	NDK4390
	2	NDK4395
	2	NDK4396
	1	NDK4400
	1	NDK4405
JM811910	1	NDK4406
	1	NDK220F
	1	NDK220FA
1	NDK432	

BEARINGS		
Part No.	Qty.	Kit
JM822010	1	NDK214
	1	NDK401
	1	NDK402
	1	NDK4437
	1	NDK4438
JM822049	1	NDK214
	1	NDK401
	1	NDK402
	1	NDK4437
JP10010A	1	NDK4438
	1	NDK4390
	1	NDK4405
JP10049	1	NDK4406
	1	NDK4390
	1	NDK4405
JP12010	1	NDK4406
	1	NDK4375
JP12049	1	NDK4375
JW6010	2	NDK651
JW6049	2	NDK651
K75X83X23	2	NDK651
	2	NDK4841
LM104949	2	NDK650F
	2	NDK172FB
	1	NDK217F
	2	NDK427
	2	NDK427A
	2	NDK428
	2	NDK428A
	2	NDK4095
	2	NDK4395
	2	NDK4396
	2	NDK4405
	2	NDK4406
	1	NDK4135
	LM11949-90013	1
1		NDK4145
1		NDK4440
1		NDK4441
LM501310	1	NDK419
	1	NDK422
	1	NDK424
LM501349	1	NDK419
	1	NDK422
LM603011	1	NDK424
	1	NDK900FA
LM603049	1	NDK900FA
M1209TV	1	NDK222F
M7309GEX	1	NDK4440
M802011	2	NDK200FA
	2	NDK201FA
M802048	2	NDK200FA
	2	NDK201FA
M804010	1	NDK216
	1	NDK4325
M804049	1	NDK216
	1	NDK4325
M903310	1	NDK2111
M903345	1	NDK2111
MA1207TV	1	NDK64FC
MA1209EL	1	NDK64F
	1	NDK64FE
MA1209TV	1	NDK64FC

BEARINGS		
Part No.	Qty.	Kit
MA1209TV	1	NDK64FD
	1	NDK196
	1	NDK207
	1	NDK422
MA1209TVV1	1	NDK424
MA1209V1	1	NDK222F
MA1211UB	1	NDK208
	1	NDK211F
	1	NDK211FA
	1	NDK426
	1	NDK431
	1	NDK433
	1	NDK449
MA1211UBV	1	NDK432
MA1211UBVV1	1	NDK208A
	1	NDK209
	1	NDK210
	1	NDK220F
MA1211V1	1	NDK220FA
MR1212EL	1	NDK432
	1	NDK204F
MR7309	1	NDK4180
MRB7309	1	NDK4440
MRC1308XECX	1	NDK4440
MU1015DCV	1	NDK4415
	1	NDK172F
MU1218TDHM	1	NDK172FA
MU1221UM	1	NDK4180
MU1305TDM	1	NDK204F
MU1308UM	1	NDK2111
	1	NDK172R
MU1309CB	1	NDK4105
	1	NDK208
	1	NDK413
	1	NDK420
MU1309CBVV1	1	NDK431
	1	NDK449
	1	NDK209
	1	NDK210
	1	NDK220F
MU1309CBXV1	1	NDK220FA
	1	NDK418
	1	NDK421
MU1309CV	1	NDK421
	1	NDK208A
MU1309UM	1	NDK426
	1	NDK211F
	1	NDK211FA
	1	NDK18D
MU1309UMV1	1	NDK401
	1	NDK402
	1	NDK431
MU5208UM	1	NDK433
	1	NDK415
MUB1305UDM	1	NDK432
	1	NDK2108
MUB1307TDM	1	NDK218
	1	NDK4310
	1	NDK4315
	1	NDK1A
1	NDK23D	
1	NDK24	
1	NDK64F	

BEARINGS		
Part No.	Qty.	Kit
MUB1307TDM	1	NDK64FE
	1	NDK192R
	1	NDK192RB
	1	NDK196
	1	NDK200F
	1	NDK200FA
	1	NDK404F
	1	NDK404FA
	1	NDK405F
	1	NDK405FA
	1	NDK412
	1	NDK427
	1	NDK427A
	1	NDK428
	1	NDK428A
	1	NDK600
	1	NDK4375
MUB1309TM	1	NDK50
MUB1309UM	1	NDK50A
	1	NDK202
	1	NDK4125
	1	NDK4135
	1	NDK4140
	1	NDK4150
1	NDK4155	
MUB5206TM	1	NDK191R
MUB5206UM	1	NDK191F
MUB7307UBM	1	NDK404R
	1	NDK405R
	1	NDK429
	1	NDK430
	1	NDK445
MUB7309UM	1	NDK4435
	1	NDK4441
MUC1309UM	1	NDK4130
	1	NDK4145
	1	NDK4155A
	1	NDK4436
	1	NDK4437
1	NDK4438	
MUF1208CBXV1	1	NDK419
	1	NDK422
MUF1209TVV1	1	NDK424
MUF1306TDM	2	NDK9F
1	NDK9R	
MUS7307UBM	1	NDK222F
	1	NDK222R
MUSB61307UM	1	NDK64FC
NP049312	1	NDK436
	1	NDK437
	1	NDK440
	1	NDK441
	1	NDK443
	1	NDK444
NP105857	1	NDK427
	1	NDK427A
	1	NDK428
	1	NDK428A
	1	NDK429
1	NDK430	
NP105857	1	NDK405F
NP120322	1	NDK436

BEARINGS		
Part No.	Qty.	Kit
NP120322	1	NDK437
	2	NDK438
	2	NDK439
	1	NDK440
	1	NDK441
	2	NDK442
	1	NDK443
	1	NDK444
	1	NDK436
	1	NDK437
NP166419	1	NDK442
	1	NDK436
NP171276	1	NDK437
	1	NDK442
NP193660	1	NDK427
	1	NDK427A
	1	NDK428
	1	NDK428A
	1	NDK436
NP237087	1	NDK437
	1	NDK440
	1	NDK441
	1	NDK443
	1	NDK444
NP293601	2	NDK4843
	1	NDK4844
NP374995	1	NDK436
	1	NDK437
	2	NDK438
	2	NDK439
	1	NDK440
	1	NDK441
	2	NDK442
	1	NDK443
	1	NDK444
	1	NDK436
NP478770	1	NDK437
	1	NDK438
	1	NDK439
	1	NDK440
	1	NDK441
	1	NDK442
	1	NDK443
	1	NDK444
	1	NDK436
	1	NDK437
NP547156	1	NDK438
	1	NDK439
	2	NDK440
	2	NDK441
	1	NDK442
	2	NDK443
	2	NDK444
	1	NDK4844
NP563664	1	NDK4844
NP718759	1	NDK4440
	1	NDK4441
NP799449	1	NDK405F
	1	NDK427
	1	NDK427A
	1	NDK428
	1	NDK428A
	1	NDK429

BEARINGS		
Part No.	Qty.	Kit
NP799449	1	NDK430
NP846736	1	NDK436
	1	NDK437
	1	NDK442
NP927527	1	NDK438
	2	NDK439
	1	NDK440
	1	NDK441
	1	NDK443
	1	NDK444
NP928171	1	NDK4440
	1	NDK4441
NP930036	1	NDK427
	1	NDK427A
	1	NDK428
NP934397	1	NDK428A
	2	NDK4843
1	NDK4844	
NP943289	1	NDK436
	1	NDK437
	1	NDK442
NP970652	1	NDK4844
RU1570UM	1	NDK217R
	1	NDK223F
	1	NDK223R
	1	NDK4390
	1	NDK4390
	1	NDK900FA
	1	NDK9RB
	1	NDK9RC
	1	NDK194F
	1	NDK194RB
	1	NDK216
	1	NDK4325
	1	NDK4330
	1	NDK4843
1	NDK4844	
RU9008UM	1	NDK416
	1	NDK4426
	1	NDK4428
TMB211	1	NDK206
	1	NDK206A
WUB61307UM	1	NDK1
	1	NDK23
	1	NDK23B
	1	NDK64FD
	1	NDK207
	1	NDK403
	1	NDK419
	1	NDK422
WUB61308UM	1	NDK424
	1	NDK201F
	1	NDK410
	1	NDK437
	1	NDK438
	1	NDK440
	1	NDK441
	1	NDK443
	1	NDK18E
	1	NDK72
1	NDK72A	



BEARINGS		
Part No.	Qty.	Kit
WUB61308UM	1	NDK72B
	1	NDK201FA
	1	NDK201R
	1	NDK208
	1	NDK208A
	1	NDK209
	1	NDK210
	1	NDK211F
	1	NDK211FA
	1	NDK214
	1	NDK219R
	1	NDK220F
	1	NDK220FA
	1	NDK406
	1	NDK413
	1	NDK418
	1	NDK420
	1	NDK421
	1	NDK426
	1	NDK431
1	NDK432	
1	NDK433	
1	NDK449	
XL497	1	NDK427
	1	NDK427A

SEALS		
Part No.	Qty.	Kit
A-4223	1	NDK194R
SLS-1666	1	NDK4095
	1	NDK4100
	1	NDK4125
	1	NDK4135
	1	NDK4140
	1	NDK4145
	1	NDK4396
	1	NDK4406
	1	NDK4420
	1	NDK4422
	1	NDK4423
	1	NDK4440
	1	NDK4441
SLS-1667	1	NDK4841
	1	NDK217F
	1	NDK4155
	1	NDK4155A
	1	NDK4395
	1	NDK4396
	1	NDK4405
SLS-1685	1	NDK4406
	1	NDK4415
	1	NDK4426
	1	NDK4428
	1	NDK4435
	1	NDK4436
	1	NDK4437
SLS-1694	1	NDK4438
	1	NDK64F
	1	NDK64FC
	1	NDK64FD
	1	NDK64FE
	1	NDK196
	1	NDK207
	1	NDK222F
SLS-1695	1	NDK422
	1	NDK424
	1	NDK72
	1	NDK196
	1	NDK207
	1	NDK222F
SLS-1696	1	NDK422
	1	NDK424
	1	NDK1
	1	NDK1A
	1	NDK23D
	1	NDK403
	1	NDK406
SLS-1697	1	NDK412
	1	NDK414
SLS-1698	1	NDK223F
SLS-1699	1	NDK404F
	1	NDK404FA
	1	NDK404R
	1	NDK405F
	1	NDK405FA
	1	NDK405R
	1	NDK427
	1	NDK427A
	1	NDK428

SEALS			
Part No.	Qty.	Kit	
SLS-1699	1	NDK428A	
	1	NDK429	
	1	NDK430	
	1	NDK434	
	1	NDK445	
SLS-1701	1	NDK404F	
	1	NDK404FA	
	1	NDK405F	
	1	NDK405FA	
	1	NDK427	
	1	NDK427A	
	1	NDK428	
	1	NDK428A	
	SLS-1702	1	NDK442
	SLS-1703	1	NDK192RB
SLS-1707	1	NDK201R	
	1	NDK223R	
SLS-1708	1	NDK9F	
	1	NDK900F	
SLS-1709	1	NDK900FA	
	1	NDK9F	
SLS-1710	1	NDK205A	
	1	NDK205	
	1	NDK206	
	1	NDK206A	
	1	NDK212F	
	1	NDK500	
	1	NDK501	
SLS-1711	1	NDK503	
	1	NDK507	
	1	NDK206	
	1	NDK206A	
	1	NDK206A	
SLS-1715	1	NDK217R	
	1	NDK206A	
	1	NDK4375	
	1	NDK4390	
	1	NDK4400	
	1	NDK4842	
SLS-1716	1	NDK4843	
	1	NDK4844	
	1	NDK200F	
	1	NDK200FA	
SLS-1717	1	NDK201FA	
	1	NDK191F	
SLS-1742	1	NDK200F	
	1	NDK200FA	
	1	NDK201F	
SLS-1743	1	NDK201FA	
	1	NDK222R	
	1	NDK117	
	1	NDK117A	
SLS-1746	1	NDK117	
	1	NDK204R	
	1	NDK18D	
	1	NDK18E	
SLS-1748	1	NDK72A	
	1	NDK72B	
	1	NDK212F	
SLS-1752	1	NDK212R	
	1	NDK506	
SLS-1752	1	NDK500	
	1	NDK507	

SEALS		
Part No.	Qty.	Kit
SLS-1768	1	NDK23
	1	NDK23B
SLS-1769	1	NDK23
	1	NDK23B
SLS-1770	1	NDK24
SLS-1771	1	NDK24
	1	NDK4310
SLS-1772	1	NDK208
	1	NDK208A
	1	NDK211FA
	1	NDK220F
	1	NDK220FA
	1	NDK431
	1	NDK432
SLS-1773	1	NDK433
	1	NDK208
	1	NDK211FA
	1	NDK431
	1	NDK432
	1	NDK433
	1	NDK436
	1	NDK437
SLS-1774	1	NDK442
	1	NDK219R
	1	NDK401
	1	NDK402
	1	NDK410
	1	NDK413
SLS-1777	1	NDK449
	1	NDK9RB
SLS-1778	1	NDK172R
SLS-1778	1	NDK23D
SLS-1779	1	NDK214
SLS-1780	1	NDK209
	1	NDK210
	1	NDK211F
	1	NDK418
	1	NDK420
	1	NDK421
	1	NDK426
SLS-1781	1	NDK209
	1	NDK210
	1	NDK211F
	1	NDK418
	1	NDK419
	1	NDK420
	1	NDK421
SLS-1782	1	NDK426
	1	NDK192R
	1	NDK201F
	1	NDK4125
SLS-1784	1	NDK4135
	1	NDK4140
	1	NDK4145
	1	NDK4440
SLS-1785	1	NDK4441
	1	NDK415
SLS-1786	1	NDK419
	1	NDK208A
SLS-1786	1	NDK220F

SEALS		
Part No.	Qty.	Kit
SLS-1786	1	NDK220FA
	1	NDK4180
SLS-1787	1	NDK99R
	1	NDK99RC
	1	NDK600
SLS-1788	1	NDK50
	1	NDK50A
	1	NDK172F
	1	NDK172FA
SLS-1804	1	NDK4330
SLS-1805	1	NDK4095
SLS-1806	1	NDK436
	1	NDK437
	1	NDK438
	1	NDK439
	1	NDK440
	1	NDK441
	1	NDK443
	1	NDK444
SLS-1807	1	NDK216
	1	NDK218
SLS-1808	1	NDK172F
	1	NDK172FA
	1	NDK172FB
	1	NDK4100
	1	NDK4180
SLS-1829	1	NDK2108
SLS-1830	1	NDK4105
SLS-1831	1	NDK4150
SLS-1832	1	NDK416
SLS-1850	1	NDK2111
SLS-1851	1	NDK2111
SLS-1862	1	NDK194F
SLS-1863	1	NDK194F
SLS-1878	1	NDK191R
SLS-1879	1	NDK191F
	1	NDK192R
SLS-1885	1	NDK172R
SLS-1950	1	NDK172FB
SLS-1951	1	NDK202
SLS-1952	1	NDK194RA
	1	NDK194RB
SLS-1956	1	NDK204F
SLS-1957	1	NDK204F
SLS-1958	1	NDK202
SLS-1959	1	NDK4325
SLS-1960	1	NDK650F
SLS-1961	1	NDK650F
SLS-1962	1	NDK650R
SLS-1963	1	NDK651
SLS-1965	1	NDK508
SLS-1966	1	NDK4315

SEALS		
Kit	Qty.	Part Number
NDK1	1	SLS-1696
NDK1A	1	SLS-1696
NDK9F	1	SLS-1707
	1	SLS-1708
NDK9R	1	SLS-1787
NDK9RB	1	SLS-1777
NDK9RC	1	SLS-1787
NDK18D	1	SLS-1746
NDK18E	1	SLS-1746
NDK23	1	SLS-1768
	1	SLS-1769
NDK23B	1	SLS-1768
	1	SLS-1769
NDK23D	1	SLS-1696
	1	SLS-1778
NDK24	1	SLS-1769
	1	SLS-1770
	1	SLS-1771
NDK50	1	SLS-1788
NDK50A	1	SLS-1788
NDK64F	1	SLS-1694
NDK64FC	1	SLS-1694
NDK64FD	1	SLS-1694
NDK64FE	1	SLS-1694
NDK72	1	SLS-1695
NDK72A	1	SLS-1746
NDK72B	1	SLS-1746
NDK117	1	SLS-1742
	1	SLS-1743
NDK117A	1	SLS-1742
NDK172F	1	SLS-1788
	1	SLS-1808
NDK172FA	1	SLS-1788
	1	SLS-1808
NDK172FB	1	SLS-1808
	1	SLS-1950
NDK172R	1	SLS-1777
	1	SLS-1885
NDK191F	1	SLS-1716
	1	SLS-1879
NDK191R	1	SLS-1878
NDK192R	1	SLS-1782
	1	SLS-1879
NDK192RB	1	SLS-1703
	1	SLS-1862
NDK194F	1	SLS-1863
	1	A-4223
NDK194RA	1	SLS-1952
NDK194RB	1	SLS-1952
NDK196	1	SLS-1694
	1	SLS-1695
NDK200F	1	SLS-1715
	1	SLS-1716
NDK200FA	1	SLS-1715
	1	SLS-1716
NDK201F	1	SLS-1716
	1	SLS-1782
NDK201FA	1	SLS-1715
	1	SLS-1716
NDK201R	1	SLS-1703
NDK202	1	SLS-1951
	1	SLS-1958

SEALS		
Kit	Qty.	Part Number
NDK204F	1	SLS-1956
	1	SLS-1957
NDK204R	1	SLS-1743
NDK205	1	SLS-1708
NDK205A	1	SLS-1708
NDK206	1	SLS-1709
	1	SLS-1710
NDK206A	1	SLS-1709
	1	SLS-1710
NDK207	1	SLS-1694
	1	SLS-1695
NDK208	1	SLS-1772
	1	SLS-1773
NDK208A	1	SLS-1772
	1	SLS-1786
NDK209	1	SLS-1780
	1	SLS-1781
NDK210	1	SLS-1780
	1	SLS-1781
NDK211F	1	SLS-1780
	1	SLS-1781
NDK211FA	1	SLS-1772
	1	SLS-1773
NDK212F	1	SLS-1709
	1	SLS-1748
NDK212R	1	SLS-1748
NDK214	1	SLS-1779
NDK216	1	SLS-1807
NDK217F	1	SLS-1667
NDK217R	1	SLS-1711
NDK218	1	SLS-1807
NDK219R	1	SLS-1774
NDK220F	1	SLS-1772
	1	SLS-1786
NDK220FA	1	SLS-1772
	1	SLS-1786
NDK222F	1	SLS-1694
	1	SLS-1695
NDK222R	1	SLS-1717
NDK223F	1	SLS-1697
	1	SLS-1698
NDK223R	1	SLS-1703
NDK401	1	SLS-1774
NDK402	1	SLS-1774
NDK403	1	SLS-1696
NDK404F	1	SLS-1699
	1	SLS-1701
NDK404FA	1	SLS-1699
	1	SLS-1701
NDK404R	1	SLS-1699
NDK405F	1	SLS-1699
	1	SLS-1701
NDK405FA	1	SLS-1699
	1	SLS-1701
NDK405R	1	SLS-1699
NDK406	1	SLS-1696
NDK410	1	SLS-1774
NDK412	1	SLS-1696
NDK413	1	SLS-1774
NDK414	1	SLS-1696
NDK415	1	SLS-1785
NDK416	1	SLS-1832

SEALS		
Kit	Qty.	Part Number
NDK418	1	SLS-1780
	1	SLS-1781
NDK419	1	SLS-1781
	1	SLS-1785
NDK420	1	SLS-1780
	1	SLS-1781
NDK421	1	SLS-1780
	1	SLS-1781
NDK422	1	SLS-1694
	1	SLS-1695
NDK424	1	SLS-1694
	1	SLS-1695
NDK426	1	SLS-1780
	1	SLS-1781
	1	SLS-1781
NDK427	1	SLS-1699
	1	SLS-1701
NDK427A	1	SLS-1699
	1	SLS-1701
NDK428	1	SLS-1699
	1	SLS-1701
NDK428A	1	SLS-1699
	1	SLS-1701
NDK429	1	SLS-1699
NDK430	1	SLS-1699
NDK431	1	SLS-1772
	1	SLS-1773
NDK432	1	SLS-1772
	1	SLS-1773
NDK433	1	SLS-1772
	1	SLS-1773
NDK434	1	SLS-1699
NDK436	1	SLS-1773
	1	SLS-1806
NDK437	1	SLS-1773
	1	SLS-1806
NDK438	1	SLS-1806
NDK439	1	SLS-1806
NDK440	1	SLS-1806
NDK441	1	SLS-1806
NDK442	1	SLS-1702
	1	SLS-1773
NDK443	1	SLS-1806
NDK444	1	SLS-1806
NDK445	1	SLS-1699
NDK449	1	SLS-1774
NDK500	1	SLS-1709
	1	SLS-1752
NDK501	1	SLS-1709
NDK503	1	SLS-1709
NDK506	1	SLS-1748
NDK507	1	SLS-1709
	1	SLS-1752
NDK508	1	SLS-1965
NDK600	1	SLS-1787
NDK650F	1	SLS-1960
	1	SLS-1961
NDK650R	1	SLS-1962
NDK651	1	SLS-1963
NDK900F	1	SLS-1707
NDK900FA	1	SLS-1707
NDK2108	1	SLS-1829

SEALS		
Kit	Qty.	Part Number
NDK2111	1	SLS-1850
	1	SLS-1851
NDK4095	1	SLS-1666
	1	SLS-1805
NDK4100	1	SLS-1666
	1	SLS-1808
NDK4105	1	SLS-1830
NDK4125	1	SLS-1666
	1	SLS-1782
NDK4130	1	SLS-1788
NDK4135	1	SLS-1666
	1	SLS-1782
NDK4140	1	SLS-1666
	1	SLS-1784
NDK4145	1	SLS-1666
	1	SLS-1784
NDK4150	1	SLS-1831
NDK4155	1	SLS-1667
NDK4155A	1	SLS-1667
NDK4180	1	SLS-1786
	1	SLS-1808
NDK4310	1	SLS-1771
NDK4315	1	SLS-1966
NDK4325	1	SLS-1959
NDK4330	1	SLS-1804
NDK4375	1	SLS-1711
NDK4390	1	SLS-1711
NDK4395	1	SLS-1667
NDK4396	1	SLS-1666
	1	SLS-1667
NDK4400	1	SLS-1711
NDK4405	1	SLS-1667
NDK4406	1	SLS-1666
	1	SLS-1667
NDK4415	1	SLS-1685
NDK4420	1	SLS-1666
NDK4422	1	SLS-1666
NDK4423	1	SLS-1666
NDK4426	1	SLS-1685
NDK4428	1	SLS-1685
NDK4435	1	SLS-1685
NDK4436	1	SLS-1685
NDK4437	1	SLS-1685
NDK4438	1	SLS-1685
NDK4440	1	SLS-1666
	1	SLS-1784
NDK4441	1	SLS-1666
	1	SLS-1784
NDK4841	1	SLS-1666
NDK4842	1	SLS-1711
NDK4843	1	SLS-1711
NDK4844	1	SLS-1711

INTERCHANGES			
Competitor Name	Competitor Part No.	Part No.	
American Bearing	RS1K	NDK1	
	RS1AK	NDK1A	
	RS9CK	NDK9RC	
DANA	99041	NDK1A	
	99044	NDK64FD	
	99048	NDK24	
	99050	NDK23D	
	99051	NDK1	
	99053	NDK72A	
	099044	NDK64FD	
	099051	NDK1	
	109368	NDK412	
	114394	NDK196	
	115125	NDK207	
	118122	NDK207	
	118122	NDK208	
	119797	NDK402	
	211222	NDK222F	
	211223	NDK222R	
	216234	NDK404F	
	216248	NDK404R	
	509689	NDK412	
	512800	NDK428	
	512803	NDK440	
	512805	NDK430	
	512806	NDK429	
	512812	NDK427	
	512814	NDK449	
	512828	NDK445	
	513279	NDK434	
	514011	NDK436	
	514012	NDK437	
	514013	NDK438	
	514014	NDK439	
	514016	NDK441	
	514238	NDK442	
	514240	NDK444	
	341KS101	NDK191R	
	300KS100X	NDK416	
	360KS100X	NDK414	
	DT Components	DRA208	NDK208
		DRA214	NDK214
		DRA216	NDK216
		DRA217R	NDK217R
		DRA218	NDK218
		DRA219R	NDK219R
		DRK1	NDK1
		DRK1A	NDK1A
		DRK9F	NDK9F
		DRK9R	NDK9R
DRK9RB		NDK9RB	
DRK9RC		NDK9RC	
DRK18D		NDK18D	
DRK18E		NDK18E	
DRK23		NDK23	
DRK23B		NDK23B	
DRK23D		NDK23D	
DRK24		NDK24	
DRK50		NDK50	
DRK50A		NDK50A	
DRK64F		NDK64F	

INTERCHANGES		
Competitor Name	Competitor Part No.	Part No.
DT Components	DRK64FC	NDK64FC
	DRK64FD	NDK64FD
	DRK64FE	NDK64FE
	DRK72	NDK72
	DRK72A	NDK72A
	DRK72B	NDK72B
	DRK117	NDK117
	DRK117A	NDK117A
	DRK172F	NDK172F
	DRK172FA	NDK172FA
	DRK172FB	NDK172FB
	DRK172R	NDK172R
	DRK191F	NDK191F
	DRK191R	NDK191R
	DRK192R	NDK192R
	DRK192RB	NDK192RB
	DRK194F	NDK194F
	DRK194R	NDK194R
	DRK194RA	NDK194RA
	DRK194RB	NDK194RB
	DRK196	NDK196
	DRK200F	NDK200F
	DRK200FA	NDK200FA
	DRK201F	NDK201F
	DRK201FA	NDK201FA
	DRK201R	NDK201R
	DRK202	NDK202
	DRK204F	NDK204F
	DRK204R	NDK204R
	DRK205	NDK205
	DRK206	NDK206
	DRK207	NDK207
	DRK208	NDK208
	DRK208A	NDK208A
	DRK209	NDK209
	DRK210	NDK210
	DRK211F	NDK211F
	DRK211FA	NDK211FA
	DRK212F	NDK212F
	DRK212R	NDK212R
	DRK214	NDK214
	DRK216	NDK216
	DRK217F	NDK217F
	DRK217R	NDK217R
	DRK218	NDK218
	DRK219R	NDK219R
	DRK220F	NDK220F
DRK220FA	NDK220FA	
DRK222F	NDK222F	
DRK222R	NDK222R	
DRK223F	NDK223F	
DRK223R	NDK223R	
DRK400	NDK440	
DRK401	NDK401	
DRK402	NDK402	
DRK403	NDK403	
DRK404F	NDK404F	
DRK404FA	NDK404FA	
DRK404R	NDK404R	
DRK405F	NDK405F	
DRK405FA	NDK405FA	

INTERCHANGES		
Competitor Name	Competitor Part No.	Part No.
DT Components	DRK405R	NDK405R
	DRK406	NDK406
	DRK410	NDK410
	DRK412	NDK412
	DRK413	NDK413
	DRK414	NDK414
	DRK415	NDK415
	DRK416	NDK416
	DRK418	NDK418
	DRK419	NDK419
	DRK420	NDK420
	DRK421	NDK421
	DRK422	NDK422
	DRK424	NDK424
	DRK426	NDK426
	DRK427	NDK427
	DRK427A	NDK427A
	DRK428	NDK428
	DRK428A	NDK428A
	DRK429	NDK429
	DRK430	NDK430
	DRK431	NDK431
	DRK432	NDK432
	DRK433	NDK433
	DRK434	NDK434
	DRK436	NDK436
	DRK437	NDK437
	DRK438	NDK438
	DRK439	NDK439
	DRK441	NDK441
	DRK442	NDK442
	DRK443	NDK443
	DRK444	NDK444
	DRK445	NDK445
	DRK449	NDK449
	DRK500	NDK500
	DRK501	NDK501
	DRK503	NDK503
	DRK506	NDK506
	DRK507	NDK507
	DRK508	NDK508
	DRK600	NDK600
	DRK650F	NDK650F
	DRK650R	NDK650R
	DRK651	NDK651
	DRK900F	NDK900F
	DRK900FA	NDK900FA
DRK2108	NDK2108	
DRK2111	NDK2111	
DRK4095	NDK4095	
DRK4100	NDK4100	
DRK4105	NDK4105	
DRK4125	NDK4125	
DRK4130	NDK4130	
DRK4135	NDK4135	
DRK4140	NDK4140	
DRK4145	NDK4145	
DRK4150	NDK4150	
DRK4155	NDK4155	
DRK4155A	NDK4155A	
DRK4180	NDK4180	

INTERCHANGES			
Competitor Name	Competitor Part No.	Part No.	
<b>DT Components</b>	DRK4310	NDK4310	
	DRK4315	NDK4315	
	DRK4325	NDK4325	
	DRK4330	NDK4330	
	DRK4375	NDK4375	
	DRK4390	NDK4390	
	DRK4396	NDK4396	
	DRK4405	NDK4405	
	DRK4406	NDK4406	
	DRK4415	NDK4415	
	DRK4420	NDK4420	
	DRK4422	NDK4422	
	DRK4423	NDK4423	
	DRK4426	NDK4426	
	DRK4428	NDK4428	
	DRK4435	NDK4435	
	DRK4436	NDK4436	
	DRK4437	NDK4437	
	DRK4438	NDK4438	
	DRK4440	NDK4440	
	DRK4441	NDK4441	
	DRK4841	NDK4841	
	DRK4842	NDK4842	
	DRK4843	NDK4843	
	DRK4844	NDK4844	
	<b>Eaton</b>	99040	NDK23B
		99041	NDK1A
		99043	NDK18D
		99044	NDK64FD
		99046	NDK207
		99046	NDK208
		99048	NDK24
		99050	NDK23D
		99051	NDK1
99052		NDK64FE	
99052		NDK72	
99096		NDK18E	
099041		NDK1A	
099043		NDK18D	
099044		NDK64FD	
099049		NDK23	
099050		NDK23D	
099051		NDK1	
099052		NDK72	
099053		NDK72A	
099096		NDK18E	
107268		NDK23B	
107269		NDK23	
107669		NDK210	
107670		NDK72A	
114394		NDK196	
115125		NDK207	
118109		NDK207	
118109		NDK208	
118118		NDK210	
118122		NDK207	
118122		NDK208	
119797		NDK402	
211222		NDK222F	
211223	NDK222R		

INTERCHANGES		
Competitor Name	Competitor Part No.	Part No.
<b>Eaton</b>	514014	NDK439
	EA23	NDK23
	RA1	NDK1
	RA1A	NDK1A
	RA9R	NDK9R
	RA9RB	NDK9RB
	RA9RC	NDK9RC
	RA18D	NDK18D
	RA18E	NDK18E
	RA23	NDK23
	RA23B	NDK23B
	RA23D	NDK23D
	RA24	NDK24
	RA50	NDK50
	RA50A	NDK50A
	RA64F	NDK64F
	RA64FC	NDK64FC
	RA64FD	NDK64FD
	RA64FE	NDK64FE
	RA72	NDK72
	RA72A	NDK72A
	RA117	NDK117
	RA172F	NDK172F
	RA172FA	NDK172FA
	RA172FB	NDK172FB
	RA172R	NDK172R
	RA191F	NDK191F
	RA191R	NDK191R
	RA192R	NDK192R
	RA192RB	NDK192RB
	RA194F	NDK194F
	RA194R	NDK194R
	RA194RA	NDK194RA
	RA194RB	NDK194RB
RA196	NDK196	
RA200F	NDK200F	
RA200FA	NDK200FA	
RA201F	NDK201F	
RA201FA	NDK201FA	
RA201R	NDK201R	
RA202	NDK202	
RA204F	NDK204F	
RA204R	NDK204R	
RA205	NDK205	
RA206	NDK206	
RA207	NDK207	
RA208	NDK208	
RA209	NDK209	
RA210	NDK210	
RA211F	NDK211F	
RA212F	NDK212F	
RA212R	NDK212R	
RA214	NDK214	
RA216	NDK216	
RA217F	NDK217F	
RA217R	NDK217R	
RA218	NDK218	
RA219R	NDK219R	
RA220F	NDK220F	
RA222F	NDK222F	
RA222R	NDK222R	
<b>Federal Mogul</b>	RA223F	NDK223F
	RA223R	NDK223R
	RA400	NDK440
	RA401	NDK401
	RA402	NDK402
	RA403	NDK403
	RA404F	NDK404F
	RA404R	NDK404R
	RA405F	NDK405F
	RA405R	NDK405R
	RA406	NDK406
	RA410	NDK410
	RA900F	NDK900F
	RA900FA	NDK900FA
	RA4100	NDK4100
	RA4130	NDK4130
	RA4135	NDK4135
	RA4315	NDK4315
	RA4325	NDK4325
	RA4330	NDK4330
	RA4375	NDK4375
	RA4390	NDK4390
	RA4395	NDK4395
	RA4396	NDK4396
	RA4405	NDK4405
	RA4406	NDK4406
	RA4415	NDK4415
	RA4420	NDK4420
	RA4422	NDK4422
	RA4423	NDK4423
	RA4426	NDK4426
	RA4428	NDK4428
	RA4435	NDK4435
	RA4436	NDK4436
RA4437	NDK4437	
RA4438	NDK4438	
RA4440	NDK4440	
<b>Freightliner</b>	BRK1014	NDK1A
	BRK1015	NDK64F
	BRK1017	NDK50
	BRK1057	NDK172R
	BRK1061	NDK196
	BRK1071	NDK18D
	BRK1082	NDK192RB
	BRK1082	NDK194F
	BRK1089	NDK1
	BRK1090	NDK23D
	BRK8160	NDK194RB
	BRK10035	NDK900FA
	BRK10041	NDK9RB
	BRK10043	NDK9RC
	BRK10131	NDK64FD
	BRK10561	NDK172FA
	BRK10562	NDK172FB
	BRK10563	NDK172FB
	BRK10821	NDK192RB
	BRK10821	NDK194F
	BRK10841	NDK194RA
	BRK10861	NDK196
	BRK100311	NDK900FA

INTERCHANGES		
Competitor Name	Competitor Part No.	Part No.
Freightliner	BRK100351	NDK900F
	BRK1003111	NDK900F
General Motors	2045926	NDK1
	2045946	NDK72A
	2049630	NDK23D
	2049632	NDK1A
	2049732	NDK64FD
	2049781	NDK18D
	2049782	NDK64FD
	2049784	NDK18E
	2097142	NDK24
	15510168	NDK72A
	15512056	NDK23
	15514770	NDK196
	15527412	NDK9RB
	15527413	NDK9RC
	15527417	NDK18D
	15527418	NDK18E
	15527419	NDK23
	15527420	NDK23B
	15527421	NDK23D
	15527425	NDK50
	15527429	NDK64FD
	15527436	NDK172FA
	15527437	NDK172FB
	15527444	NDK191R
	15527450	NDK192RB
	15527453	NDK194F
	15527454	NDK194R
	15527461	NDK201F
	15527462	NDK201R
	15527463	NDK202
	15527467	NDK205
	15527468	NDK206
	15527469	NDK900F
15527470	NDK900FA	
International	161519C91	NDK201R
	360570C93	NDK24
	360571C93	NDK23
	369244C93	NDK1A
	380866C92	NDK50
	420030C93	NDK23D
	422291C92	NDK18D
	435200C91	NDK194F
	441452C93	NDK1
	441453C93	NDK64F
	441454C93	NDK9RC
	450083C93	NDK191R
	450085C93	NDK192R
	452602C93	NDK194F
	483250C91	NDK72A
	499685C91	NDK200F
	499686C92	NDK192RB
	499687C92	NDK201F
	499688C92	NDK201R
	504266C92	NDK202
	574274C92	NDK64FD
	574275C92	NDK64FE
	583428C92	NDK194RA
1651515C91	NDK202	
1651516C91	NDK191R	

INTERCHANGES		
Competitor Name	Competitor Part No.	Part No.
International	1651517C91	NDK192RB
	1651519C91	NDK201R
	1651524C91	NDK201F
	1651526C91	NDK24
	1651527C91	NDK1
	1651528C91	NDK23
	1651530C91	NDK23D
	1651531C91	NDK64FD
	1651532C91	NDK1A
	1651533C91	NDK64FE
	1651536C91	NDK50
	1651539C91	NDK194R
	1651540C91	NDK900F
	1651541C91	NDK9RC
	1651542C91	NDK900F
	1653126C91	NDK214
	1665329C91	NDK223R
1665333C91	NDK223F	
Kenworth	4BKT042	NDK64FE
	4BKT043	NDK1
	4BKT044	NDK50
	4BKT045	NDK172FA
	4BKT046	NDK172R
	4BKT052	NDK1A
	4BKT055	NDK9RC
	4BKT058	NDK172FA
	4BKT064	NDK194F
	4BKT065	NDK194R
	4BKT085	NDK72A
	4BKT100	NDK172FA
	4BKT104	NDK172FB
Koyo	BKD1	NDK1
	BKD1A	NDK1A
	BKD9R	NDK9R
	BKD9RC	NDK9RC
	BKD24	NDK24
	BKD64FE	NDK64FE
	BKD172FA	NDK172FA
	BKD172FB	NDK172FB
	BKD172R	NDK172R
	BKD192RB	NDK192RB
	BKD194F	NDK194F
	BKD194RA	NDK194RA
	BKD200F	NDK200F
BKD201F	NDK201F	
BKD201R	NDK201R	
BKD202	NDK202	
BKD204R	NDK204R	
L & S Bearing	RS1K	NDK1
	RS1AK	NDK1A
Mack	205SP71	NDK205
	205SP72	NDK206
	205SP73	NDK206
	1458DK24	NDK24
	1458DK64FE	NDK64FE
	1458DK72A	NDK72A
	1458DK194RB	NDK194RB
	1458DK200F	NDK200F
	1458DK207	NDK207
	1458DK208	NDK208
	1458DK210	NDK210

INTERCHANGES		
Competitor Name	Competitor Part No.	Part No.
Mack	1458DK211F	NDK211F
	1458DK217F	NDK217F
	1458DK217R	NDK217R
	1548DK216	NDK216
Meritor	1911	NDK194R
	1912	NDK194F
	1913	NDK900F
	1914	NDK900F
	1915	NDK9RB
	1916	NDK9RC
	1922	NDK172R
	1923	NDK172FB
	1923A	NDK172FB
	1924	NDK50
	1934	NDK50
	1976	NDK194RA
	1995	NDK194F
	2100	NDK194RA
	2112	NDK194RB
	2131	NDK216
	2146	NDK217F
	2159	NDK217R
	4000	NDK900F
	4005	NDK9RC
	4010	NDK9RB
	4015	NDK900FA
	4035	NDK194F
	4040	NDK194R
	4045	NDK194RA
	4050	NDK194RA
	4055	NDK194F
	4060	NDK194RB
	4065	NDK194RB
	4075	NDK172R
	4080	NDK172FB
	4085	NDK172F
	4090	NDK172F
	4090	NDK172FA
	4095	NDK172FB
	4100	NDK172FB
	4105	NDK172R
	4110	NDK50
4130	NDK4130	
4135	NDK4135	
4150	NDK50	
4315	NDK4315	
4325	NDK4325	
4330	NDK4330	
4340	NDK218	
4365	NDK216	
4375	NDK4375	
4390	NDK4390	
4395	NDK4395	
4396	NDK4396	
4400	NDK217R	
4405	NDK4405	
4406	NDK4406	
4415	NDK4415	
4420	NDK4420	
4422	NDK4422	
4423	NDK4423	



INTERCHANGES		
Competitor Name	Competitor Part No.	Part No.
Meritor	4426	NDK4426
	4428	NDK4428
	4435	NDK4435
	4436	NDK4436
	4437	NDK4437
	4438	NDK4438
	4440	NDK4440
Motive Gear	RA1AR	NDK1A
	RA1R	NDK1
	RA23B	NDK23B
	RA23R	NDK23
	RA172FBR	NDK172FB
	RA194FR	NDK194F
	RA194RAR	NDK194RA
	RA194RBR	NDK194RB
	RA194RR	NDK194R
	RA200FR	NDK200F
	RA200FRL	NDK200FA
	RA202R	NDK202
	RA205R	NDK205
	RA206R	NDK206
	RA214R	NDK214
	RA216R	NDK216
	RA217FR	NDK217F
	RA217RR	NDK217R
	RA218R	NDK218
	RA222RR	NDK222R
RA223FR	NDK223F	
NA	NA	NDK205A
	NA	NDK206A
	NA	NDK4400
National	RA1	NDK1
	RA1A	NDK1A
	RA9R	NDK9R
	RA9RB	NDK9RB
	RA9RC	NDK9RC
	RA18D	NDK18D
	RA18E	NDK18E
	RA23	NDK23
	RA23B	NDK23B
	RA23D	NDK23D
	RA24	NDK24
	RA50	NDK50
	RA50A	NDK50A
	RA64F	NDK64F
	RA64FC	NDK64FC
	RA64FD	NDK64FD
	RA64FE	NDK64FE
	RA72	NDK72
	RA72A	NDK72A
	RA117	NDK117
	RA172F	NDK172F
	RA172FA	NDK172FA
	RA172FB	NDK172FB
	RA172R	NDK172R
	RA191F	NDK191F
	RA191R	NDK191R
	RA192R	NDK192R
	RA192RB	NDK192RB
	RA194F	NDK194F
	RA194R	NDK194R

INTERCHANGES		
Competitor Name	Competitor Part No.	Part No.
National	RA194RA	NDK194RA
	RA194RB	NDK194RB
	RA196	NDK196
	RA200F	NDK200F
	RA200FA	NDK200FA
	RA201F	NDK201F
	RA201FA	NDK201FA
	RA201R	NDK201R
	RA202	NDK202
	RA204F	NDK204F
	RA204R	NDK204R
	RA205	NDK205
	RA206	NDK206
	RA207	NDK207
	RA208	NDK208
	RA209	NDK209
	RA210	NDK210
	RA211F	NDK211F
	RA212F	NDK212F
	RA212R	NDK212R
	RA214	NDK214
	RA216	NDK216
	RA217F	NDK217F
	RA217R	NDK217R
	RA218	NDK218
	RA219R	NDK219R
	RA220F	NDK220F
	RA222F	NDK222F
	RA222R	NDK222R
	RA223F	NDK223F
	RA223R	NDK223R
	RA400	NDK440
	RA401	NDK401
	RA402	NDK402
	RA403	NDK403
	RA404F	NDK404F
	RA404R	NDK404R
	RA405F	NDK405F
	RA405R	NDK405R
	RA406	NDK406
	RA410	NDK410
	RA900F	NDK900F
	RA900FA	NDK900FA
	RA4100	NDK4100
	RA4130	NDK4130
	RA4135	NDK4135
	RA4315	NDK4315
	RA4325	NDK4325
	RA4330	NDK4330
	RA4375	NDK4375
	RA4390	NDK4390
	RA4395	NDK4395
RA4396	NDK4396	
RA4405	NDK4405	
RA4406	NDK4406	
RA4415	NDK4415	
RA4420	NDK4420	
RA4422	NDK4422	
RA4423	NDK4423	
RA4426	NDK4426	
RA4428	NDK4428	

INTERCHANGES			
Competitor Name	Competitor Part No.	Part No.	
National	RA4435	NDK4435	
	RA4436	NDK4436	
	RA4437	NDK4437	
	RA4438	NDK4438	
	RA4440	NDK4440	
Navistar	282044C94	NDK72	
	360570C93	NDK24	
	441452C93	NDK1	
	441454C93	NDK9RC	
	441455C93	NDK900FA	
	450087C92	NDK172R	
	450087C93	NDK172R	
	483250C91	NDK72A	
	499685C91	NDK200F	
	499685C92	NDK200F	
	499688C92	NDK201R	
	574273C92	NDK18E	
	574273C92	NDK64FE	
	574276C92	NDK172FB	
	583428C92	NDK194RA	
	1551527C91	NDK1A	
	1651523C91	NDK200F	
	1651526C91	NDK24	
	1651527C91	NDK1	
	1651529C91	NDK72	
	1651533C91	NDK64FE	
	1651541C91	NDK9RC	
	1651544C91	NDK172FB	
	1653126C91	NDK214	
	1681149C91	NDK172F	
	441452093	NDK1	
	499685092	NDK200F	
	Newstar	S9553	NDK1
		S9553	NDK1A
		S9554	NDK18E
		S9555	NDK23D
		S9556	NDK24
S9559		NDK72A	
S9561		NDK172FB	
S9562		NDK172R	
S9563		NDK191R	
S9566		NDK192RB	
S9568		NDK194R	
S9568		NDK194RA	
S9569		NDK194RB	
S9570		NDK194F	
S9571		NDK196	
S9572		NDK200F	
S9573		NDK201F	
S9574		NDK201R	
S9576		NDK205	
S9577		NDK206	
S9578		NDK217F	
S9580		NDK222R	
S9582		NDK900F	
S9705		NDK9RB	
S9779		NDK9RC	
S9839		NDK218	
S9893		NDK223F	
S17325		NDK4422	
S21385		NDK405F	

INTERCHANGES		
Competitor Name	Competitor Part No.	Part No.
Newstar	SA469	NDK223R
	SA574	NDK217R
	SB008	NDK211F
	SB069	NDK207
	SB069	NDK208
	SB937	NDK404F
	SB938	NDK404R
	SC545	NDK4390
	SC546	NDK4396
	SC547	NDK4405
	SC548	NDK4406
	SC550	NDK4423
	SC551	NDK4426
	SC552	NDK4428
	SC554	NDK4437
	SC672	NDK219R
	SD792	NDK200FA
	SF245	NDK4420
PAI	BBK7121	NDK206
	BBK7125	NDK206
	BBK7141	NDK205
Rockwell	1908	NDK204R
	1911	NDK194R
	1912	NDK194F
	1913	NDK900F
	1914	NDK900F
	1915	NDK9RB
	1916	NDK9RC
	1921	NDK172FA
	1924	NDK50
	1934	NDK50
	2112	NDK194RB
	2131	NDK216
	2146	NDK217F
	2159	NDK217R
	4000	NDK900F
	4005	NDK9RC
	4010	NDK9RB
	4015	NDK900FA
	4035	NDK194F
	4040	NDK194R
	4055	NDK194F
	4060	NDK194RB
	4065	NDK194RB
	4085	NDK172F
	4090	NDK172F
	4090	NDK172FA
	4110	NDK50
	4130	NDK4130
	4135	NDK4135
	4150	NDK50
	4235	NDK204R
	4315	NDK4315
	4325	NDK4325
	4330	NDK4330
	4340	NDK218
	4365	NDK216
	4375	NDK4375
	4390	NDK4390
	4395	NDK4395
	4396	NDK4396

INTERCHANGES		
Competitor Name	Competitor Part No.	Part No.
Rockwell	4400	NDK217R
	4405	NDK4405
	4406	NDK4406
	4415	NDK4415
	4420	NDK4420
	4422	NDK4422
	4423	NDK4423
	4426	NDK4426
	4428	NDK4428
	4435	NDK4435
	4436	NDK4436
	4437	NDK4437
	4438	NDK4438
	4440	NDK4440
	FSD1	NDK1
	FSD1A	NDK1A
	FSD9R	NDK9R
	FSD9RB	NDK9RB
	FSD9RC	NDK9RC
	FSD18D	NDK18D
FSD18E	NDK18E	
FSD23	NDK23	
FSD23B	NDK23B	
FSD23D	NDK23D	
FSD50	NDK50	
FSD72A	NDK72A	
FSD172FA	NDK172FA	
FSD172FB	NDK172FB	
FSD172R	NDK172R	
FSD191R	NDK191R	
FSD192R	NDK192R	
FSD194F	NDK194F	
FSD194RRA	NDK194RA	
FSD196	NDK196	
FSD200F	NDK200F	
FSD201F	NDK201F	
FSD201R	NDK201R	
FSD202	NDK202	
FSD205	NDK205	
FSD206	NDK206	
FSD207	NDK207	
FSD900F	NDK900F	
FSD900FA	NDK900FA	
Sealed Power	251R	NDK172FA
	255R	NDK9RC
	256R	NDK9RB
	257R	NDK900F
	258R	NDK172R
	259R	NDK900FA
	262R	NDK50
	263R	NDK172F
	264R	NDK172FB
	270R	NDK1
	272R	NDK18D
	273R	NDK64F
	278R	NDK201F
	280R	NDK201R
	283R	NDK18E
	287R	NDK72A
	289R	NDK191R
	291R	NDK194RA
SKF	4400	NDK217R
	4405	NDK4405
	4406	NDK4406
	4415	NDK4415
	4420	NDK4420
	4422	NDK4422
	4423	NDK4423
	4426	NDK4426
	4428	NDK4428
	4435	NDK4435
	4436	NDK4436
	4437	NDK4437
	4438	NDK4438
	4440	NDK4440
	FSD1	NDK1
	FSD1A	NDK1A
	FSD9R	NDK9R
	FSD9RB	NDK9RB
FSD9RC	NDK9RC	
FSD18D	NDK18D	
FSD18E	NDK18E	
FSD23	NDK23	
FSD23B	NDK23B	
FSD23D	NDK23D	
FSD50	NDK50	
FSD72A	NDK72A	
FSD172FA	NDK172FA	
FSD172FB	NDK172FB	
FSD172R	NDK172R	
FSD191R	NDK191R	
FSD192R	NDK192R	
FSD194F	NDK194F	
FSD194RRA	NDK194RA	
FSD196	NDK196	
FSD200F	NDK200F	
FSD201F	NDK201F	
FSD201R	NDK201R	
FSD202	NDK202	
FSD205	NDK205	
FSD206	NDK206	
FSD207	NDK207	
FSD900F	NDK900F	
FSD900FA	NDK900FA	

INTERCHANGES		
Competitor Name	Competitor Part No.	Part No.
SKF	DK1A	NDK1A
	DK9R	NDK9R
	DK9RC	NDK9RC
	DK18D	NDK18D
	DK18E	NDK18E
	DK23	NDK23
	DK23B	NDK23B
	DK23D	NDK23D
	DK24	NDK24
	DK50	NDK50
	DK64FD	NDK64FD
	DK64FE	NDK64FE
	DK72A	NDK72A
	DK172F	NDK172F
	DK172FA	NDK172FA
	DK172FB	NDK172FB
	DK172R	NDK172R
	DK191R	NDK191R
	DK192R	NDK192R
	DK192RB	NDK192RB
	DK194-F	NDK194F
	DK194R	NDK194R
	DK194RA	NDK194RA
	DK194RB	NDK194RB
	DK196	NDK196
	DK200F	NDK200F
	DK200FA	NDK200FA
	DK201F	NDK201F
	DK201FA	NDK201FA
	DK201R	NDK201R
	DK202	NDK202
	DK204F	NDK204F
	DK205	NDK205
	DK207	NDK207
	DK208	NDK208
	DK209	NDK209
	DK210	NDK210
	DK211F	NDK211F
	DK214	NDK214
	DK216	NDK216
	DK217F	NDK217F
	DK217R	NDK217F
DK218	NDK218	
DK219R	NDK219R	
DK220F	NDK220F	
DK222F	NDK222F	
DK222R	NDK222R	
DK223F	NDK223F	
DK223R	NDK223R	
DK400	NDK440	
DK402	NDK402	
DK403	NDK403	
DK404F	NDK404F	
DK404R	NDK404R	
DK406	NDK406	
DK410	NDK410	
DK4100	NDK4100	
DK4130	NDK4130	
DK4315	NDK4315	
DK4325	NDK4325	
DK4330	NDK4330	

INTERCHANGES		
Competitor Name	Competitor Part No.	Part No.
SKF	DK4390	NDK4390
	DK4395	NDK4395
	DK4396	NDK4396
	DK4405	NDK4405
	DK4415	NDK4415
	DK4420	NDK4420
	DK4422	NDK4422
	DK4423	NDK4423
	DK4426	NDK4426
	DK4428	NDK4428
	SDK1	NDK1
	SDK1A	NDK1A
	SDK9RC	NDK9R
	SDK9RC	NDK9RC
	SDK18E	NDK18E
	SDK23D	NDK23D
	SDK24	NDK24
	SDK50	NDK50
	SDK64FD	NDK64FD
	SDK64FE	NDK64FE
	SDK72	NDK72
	SDK72A	NDK72A
	SDK172F	NDK172F
	SDK172FA	NDK172FA
	SDK172FB	NDK172FB
	SDK172R	NDK172R
	SDK192RB	NDK192RB
	SDK194F	NDK194F
	SDK194RA	NDK194RA
	SDK194RB	NDK194RB
	SDK196	NDK196
	SDK200F	NDK200F
	SDK200FA	NDK200FA
	SDK201F	NDK201F
	SDK201FA	NDK201FA
	SDK201R	NDK201R
	SDK202	NDK202
	SDK205	NDK205
	SDK206	NDK206
	SDK207	NDK207
	SDK208	NDK208
	SDK210	NDK210
	SDK211F	NDK211F
	SDK214	NDK214
	SDK216	NDK216
	SDK217F	NDK217F
SDK217R	NDK217R	
SDK218	NDK218	
SDK219R	NDK219R	
SDK222F	NDK222F	
SDK222R	NDK222R	
SDK223F	NDK223F	
SDK223R	NDK223R	
SDK402	NDK402	
SDK404F	NDK404F	
SDK404R	NDK404R	
SDK4390	NDK4390	
SDK4395	NDK4395	
SDK4396	NDK4396	
SDK4405	NDK4405	
SDK4406	NDK4406	

INTERCHANGES			
Competitor Name	Competitor Part No.	Part No.	
SKF	SDK4422	NDK4422	
	SDK4423	NDK4423	
	SDK4426	NDK4426	
	SDK4428	NDK4428	
	SDK900F	NDK900F	
	SDK900FA	NDK900FA	
	VKBA251	NDK172FA	
	VKBA255	NDK9RC	
	VKBA256	NDK9RB	
	VKBA257	NDK900F	
	VKBA258	NDK172R	
	VKBA259	NDK900FA	
	VKBA260	NDK194F	
	VKBA261	NDK194R	
	VKBA262	NDK50	
	VKBA264	NDK172FB	
	VKBA270	NDK1	
	VKBA271	NDK1A	
	VKBA272	NDK18D	
	VKBA275	NDK23B	
	VKBA278	NDK201F	
	VKBA279	NDK194RB	
	VKBA280	NDK201R	
	VKRA287R	NDK72A	
	VKRA301R	NDK205	
	VKRA305R	NDK204R	
	VKRA329R	NDK204F	
	Timken	DRK1	NDK1
		DRK1A	NDK1A
		DRK9F	NDK9F
		DRK9R	NDK9R
		DRK9RB	NDK9RB
		DRK9RC	NDK9RC
DRK18D		NDK18D	
DRK18E		NDK18E	
DRK23		NDK23	
DRK23B		NDK23B	
DRK23D		NDK23D	
DRK24		NDK24	
DRK50		NDK50	
DRK50A		NDK50A	
DRK64F		NDK64F	
DRK64FC		NDK64FC	
DRK64FD		NDK64FD	
DRK64FE		NDK64FE	
DRK72		NDK72	
DRK72A		NDK72A	
DRK72B		NDK72B	
DRK117		NDK117	
DRK117A		NDK117A	
DRK172F		NDK172F	
DRK172FA		NDK172FA	
DRK172FB		NDK172FB	
DRK172R		NDK172R	
DRK191F		NDK191F	
DRK191R		NDK191R	
DRK192R		NDK192R	
DRK192RB		NDK192RB	
DRK194F		NDK194F	
DRK194R		NDK194R	
DRK194RA	NDK194RA		

INTERCHANGES		
Competitor Name	Competitor Part No.	Part No.
Timken	DRK194RB	NDK194RB
	DRK196	NDK196
	DRK200F	NDK200F
	DRK200FA	NDK200FA
	DRK201F	NDK201F
	DRK201FA	NDK201FA
	DRK201R	NDK201R
	DRK202	NDK202
	DRK204F	NDK204F
	DRK204R	NDK204R
	DRK205	NDK205
	DRK206	NDK206
	DRK207	NDK207
	DRK208	NDK208
	DRK208A	NDK208A
	DRK209	NDK209
	DRK210	NDK210
	DRK211F	NDK211F
	DRK211FA	NDK211FA
	DRK212F	NDK212F
	DRK212R	NDK212R
	DRK214	NDK214
	DRK216	NDK216
	DRK217F	NDK217F
	DRK217R	NDK217R
	DRK218	NDK218
	DRK219R	NDK219R
	DRK220F	NDK220F
	DRK220FA	NDK220FA
	DRK222F	NDK222F
	DRK222R	NDK222R
	DRK223F	NDK223F
	DRK223R	NDK223R
	DRK400	NDK440
	DRK401	NDK401
	DRK402	NDK402
	DRK403	NDK403
	DRK404F	NDK404F
	DRK404FA	NDK404FA
	DRK404R	NDK404R
	DRK405F	NDK405F
	DRK405R	NDK405R
	DRK406	NDK406
	DRK410	NDK410
	DRK412	NDK412
	DRK413	NDK413
DRK414	NDK414	
DRK415	NDK415	
DRK416	NDK416	
DRK418	NDK418	
DRK419	NDK419	
DRK420	NDK420	
DRK421	NDK421	
DRK422	NDK422	
DRK424	NDK424	
DRK426	NDK426	
DRK427	NDK427	
DRK428	NDK428	
DRK429	NDK429	
DRK430	NDK430	
DRK431	NDK431	

INTERCHANGES		
Competitor Name	Competitor Part No.	Part No.
Timken	DRK432	NDK432
	DRK433	NDK433
	DRK434	NDK434
	DRK436	NDK436
	DRK437	NDK437
	DRK438	NDK438
	DRK439	NDK439
	DRK441	NDK441
	DRK442	NDK442
	DRK443	NDK443
	DRK444	NDK444
	DRK445	NDK445
	DRK449	NDK449
	DRK500	NDK500
	DRK501	NDK501
	DRK503	NDK503
	DRK506	NDK506
	DRK600	NDK600
	DRK650F	NDK650F
	DRK650R	NDK650R
	DRK651	NDK651
	DRK900F	NDK900F
	DRK900FA	NDK900FA
	DRK2108	NDK2108
	DRK2111	NDK2111
	DRK4095	NDK4095
	DRK4100	NDK4100
	DRK4105	NDK4105
	DRK4125	NDK4125
	DRK4130	NDK4130
	DRK4135	NDK4135
	DRK4140	NDK4140
	DRK4145	NDK4145
	DRK4150	NDK4150
	DRK4155	NDK4155
	DRK4155A	NDK4155A
	DRK4180	NDK4180
	DRK4310	NDK4310
	DRK4315	NDK4315
	DRK4325	NDK4325
	DRK4330	NDK4330
	DRK4375	NDK4375
	DRK4390	NDK4390
	DRK4395	NDK4395
DRK4396	NDK4396	
DRK4405	NDK4405	
DRK4406	NDK4406	
DRK4415	NDK4415	
DRK4420	NDK4420	
DRK4422	NDK4422	
DRK4423	NDK4423	
DRK4426	NDK4426	
DRK4428	NDK4428	
DRK4435	NDK4435	
DRK4436	NDK4436	

INTERCHANGES		
Competitor Name	Competitor Part No.	Part No.
Timken	DRK4437	NDK4437
	DRK4438	NDK4438
	DRK4440	NDK4440
	DRK4441	NDK4441
	EA1	NDK1
	EA1A	NDK1A
	EA23B	NDK23B
	EA23D	NDK23D
	EA64FC1	NDK64FD
	EA72	NDK72
	EA72A	NDK72A
	EA72A1	NDK72A
	EA195	NDK196
	IH200F	NDK200F
	IH201F	NDK201F
	IH202	NDK202
	MA38F	NDK206
	MA38F1	NDK206
	MA38R1	NDK205
	RA172F	NDK172F
	RS9RB	NDK9RB
	RS50	NDK50
	RS172F	NDK172F
	RS172FA	NDK172FA
	RS172FA1	NDK172FB
	RS172R	NDK172R
	RS194F1	NDK194F
	RS194R	NDK194R
	RS196R	NDK196
	RS900F	NDK900F
	RS900F1	NDK900F
	RS900F2	NDK900F
	RS900F3	NDK900F
	RS900F4	NDK900F
	RS900F5	NDK900F
	TIH192RAB	NDK192RB
	TRA1	NDK1
	TRA1A	NDK1A
	TRA9R	NDK9R
	TRA9RB	NDK9RB
	TRA9RC	NDK9RC
	TRA18D	NDK18D
	TRA18E	NDK18E
	TRA23	NDK23
TRA23B	NDK23B	
TRA23D	NDK23D	
TRA24	NDK24	
TRA50	NDK50	
TRA64F	NDK64F	
TRA64FD	NDK64FD	
TRA72	NDK72	
TRA172F	NDK172F	
TRA172FA	NDK172FA	
TRA172FB	NDK172FB	
TRA172R	NDK172R	

INTERCHANGES		
Competitor Name	Competitor Part No.	Part No.
Timken	TRA191R	NDK191R
	TRA192R	NDK192R
	TRA192RB	NDK192RB
	TRA194F	NDK194F
	TRA194R	NDK194R
	TRA194RA	NDK194RA
	TRA194RB	NDK194RB
	TRA196	NDK196
	TRA201R	NDK201R
	TRA202	NDK202
	TRA204R	NDK204R
	TRA205	NDK205
	TRA206	NDK206
	TRA207	NDK207
	TRA208	NDK208
	TRA210	NDK210
	TRA211F	NDK211F
	TRA214	NDK214
	TRA216	NDK216
	TRA217F	NDK217F
	TRA217R	NDK217R
	TRA219R	NDK219R
	TRA222F	NDK222F
	TRA222R	NDK222R
	TRA223F	NDK223F
	TRA223R	NDK223R
	TRA900F	NDK900F
	TRA900FA	NDK900FA
	TRS9RB	NDK9RB
	TRS9RC	NDK9RC
	TRS172FA	NDK172FA
	TRS172FAB	NDK172FB
	TRS172R	NDK172R
TRS194F	NDK194F	
TRS194R	NDK194R	
TRS194RA	NDK194RA	
TRS900F	NDK900F	
TRS900FA	NDK900F	
TRS900FB	NDK900F	
TRS900FC	NDK900F	
TRS900FD	NDK900F	
TRS900FE	NDK900F	
White Truck	217123A	NDK64F
	700352	NDK1
	700358B	NDK9R
	7074176	NDK50
	7074180	NDK172F
	7074181	NDK172R
	7075442	NDK18D
	7076067	NDK172FA
	7077840	NDK72A
	330905344	NDK900F
	943025233	NDK9RC

---

---

---

---

---

---

---

---

---

---

---

---

---

---

---

---

---

---

---

---

---

---

---

---

---

---

---

---

---

---

---

---

---

---

---

---

---

---

---

---

---

---

---

---

---

---

---

---

---

---

---

---

---

---

---

---

---

---

Lined area for notes, consisting of numerous horizontal lines for writing.

# BOWER<sup>®</sup>

HEAVY DUTY BEARINGS by **NTN**



The NTN BOWER story began in 1904 when R.F. BOWER of Dayton, Ohio patented his newly designed thrust controlling roller bearing. Over 100 years later our commitment to quality and innovation is still thriving in our manufacturing plants in Macomb, Illinois and Hamilton, Alabama to bring you the highest quality components available. NTN acquired BOWER in 1987. For decades, your only source of genuine BOWER bearings has been NTN.



NTN BEARING CORPORATION OF AMERICA  
1600 E. Bishop Ct., Mt. Prospect, IL 60056-7604 | 847.298.7500 | 800.323.2358

NTN Bearing Corporation of America © 2017 All rights reserved.

DIFFCAT1217 replaces DIFFCAT0416